BUYLOG SECTION 8

Low voltage power & insulated case circuit breakers





Table of contents

	SACE Emax 3 low voltage power circuit breakers	8-119	Circuit breakers
8-4	UL 1066	8-120	Cradles
8-8	Switch disconnectors UL 1066		Accessories
8-9	Multi-standard version IEC 60947, UL1066 and CCC	8-121	Electrical accessories
8-10	Instructions for ordering	8-126	Mechanical accessories
8-10	SACE Emax 3 configured circuit breaker/switch disconnecter order code breakdown	8-130	Mechanical interlock
8-19	SACE Emax 3 cradle (fixed part) order code breakdown	8-132	Ekip modules
8-21	SACE Emax 3 accessories order code breakdown	8-135	Terminals
8-22	General information	8-139	Spare parts Grey Platform
	Automatic circuit breakers	8-141	Service
8-23	Fixed version for power distribution	8-142	Spare Parts
8-28	Drawout version for power distribution		Low voltage power and DC circuit breakers
	Switch disconnectors	8-148	EntelliGuard™ G low voltage power circuit breakers
8-33	Fixed version	8-148	Overview and Functions
8-35	Drawout version	8-150	EntelliGuard™ TU Trip Units
8-37	Circuit breakers	8-151	Product Nomenclature
8-38	Cradles	8-157	Cassettes Nomenclature
	Accessories	8-159	Accessories
8-39	Control	8-170	OEM Substructures and Substructure Accessories
8-42	Measurement & Protection	8-172	Trip Units
8-44	Signalling & Input/Output	8-173	Overview – EntelliGuard™ TU, Power+ and Enhanced MicroVersaTrip™
8-47	Safety & IP Protection	8-178	Product Number Nomenclature System
8-53	Interlocks	8-187	Trip Unit Conversion Kits Introduction
8-54	Connectivity	8-190	ProTrip™ Trip Unit Conversion Kits Selection Guide
8-56	Displaying	8-194	ProTrip™ Rating Plugs
8-57	Digital upgrades	8-195	EntelliGuard™ TU Trip Unit Conversion Kits Selection Guide
8-59	Power Connections	8-200	EntelliGuard™ TU Trip Unit Conversion Kit Accessories and Hardware
8-63	Miscellaneous	8-202	Trip Unit Accessories
8-64	Service	8-204	Asbestos Free Arc Quencher Replacement Kits
	SACE Emax 2 low voltage power circuit breakers	8-205	Gerapid High Speed DC Circuit Breakers
8-65	Instructions for ordering		Insulated case circuit breakers
8-65	SACE Emax 2 configured circuit breaker/switch disconnecter order code breakdown	8-210	Power Break™ II
8-73	SACE Emax 2 cradle (fixed part) order code breakdown	8-210	Features
8-75	SACE Emax 2 switch disconnecter (MS/DC-E 1500VDC) order code breakdown	8-211	Construction Options
8-79	SACE Emax 2 cradle MS/DC-E 1500VDC (fixed part) order code breakdown	8-212	EntelliGuard™ TU Trip Unit Features
8-81	Ordering examples	8-214	Enhanced MicroVersaTrip™ Trip Unit Features
8-83	General information	8-215	Trip Unit Characteristics
	Automatic circuit breakers	8-218	Power Break™ II Nomenclature System
8-84	Fixed version for power distribution	8-227	Interrupting Capacity and Withstand Ratings
8-95	Drawout version for power distribution	8-228	How to Order
8-105	Fixed version for generators	8-229	Trip Unit Selection
8-110	Drawout version for generators	8-231	Enhanced MicroVersaTrip™ Rating Plug Selection
	Switch disconnectors	8-232	Stationary and Draw-out Switch Selection
8-115	Fixed version	8-233	Stationary and Draw-out Breaker Accessories
8-117	Drawout version	8-239	Stationary Breaker Mounting Kits
		8-240	Stationary Breaker Mounting Kits, Wall Mounted Enclosures, Floor Mounted Enclosures
		8-241	Neutral Current Sensors and POWER LEADER™ Accessories
		8-242	Draw-out Breaker Accessories
		8-244	Reference Publications

SACE Emax 3 low voltage power circuit breakers

UL 1066

Common data

Rated maximum voltage	[V]	635
Rated voltage	[V]	600
Test voltage (1min. 50/60 Hz)	[kV]	2.2
Frequency	[Hz]	50 - 60
Number of poles		3-4
Version		Fixed (F) - Drawout (W)



SACE Emax 3 UL 1066

E1.3

Performance levels

			B-A	N-A	S-A
Rated uninterrupted current I _u @ 40°C		[A]	800	800	250
		[A]	1200	1200	400
		[A]			800
		[A]			1200
Neutral pole current-carrying capacity for 4-pole CBs		[%I _u]	100	100	100
Interrupting rating at rated maximum voltage	254 V	[kA]	42	50	65
	508 V	[kA]	42	50	65
	635 V	[kA]	42	42	42
Rated short time current (30 cycle/0.5s)		[kA]	42	50	50
Breaking ¹	Breaking time for I < I _{cw}	[ms]	40	40	40
	Breaking time for I > I _{cw}	[ms]	25	25	25

¹ Total clearing time is the sum of breaking time and trip time

Dimensions and weight

Dimensions	H - Fixed/Drawout	[in/mm]	11.65 [in] - 296 [mm]/14.33 [in] - 363.5 [mm]
	D - Fixed/Drawout	[in/mm]	7.20 [in] - 183 [mm]/ 11.06 [in]- 281 [mm]
	W - Fixed 3p/4p	[in/mm]	8.27 [in] - 210 [mm]/ 11.02 [in]-280 [mm]
	W - Drawout 3p/4p	[in/mm]	10.94 [in] - 278 [mm]/13.70 [in]-348 [mm]
Weights (CB with trip unit/current sensors/standard accessories)	Fixed 3p/4p	[lbs/Kg]	30.9 [lbs] - 14 [kg]/35.3 [lbs] - 16 [kg]
	Drawout 3p/4p including fixed part	[lbs/Kg]	90.4 [lbs]- 41 [kg]/102.5 [lbs] - 46.5 [kg]

SACE Emax 3 UL 1066

E1.3

Mechanical life with regular ordinary maintenance prescribed by the manufacturer		[I _u]	[A]	< 800	800	1200
			[No. cycles x 1000]	20	20	20
	Frequency		[Oper./Hour]	60	60	60
Electrical life with regular ordinary maintenance prescribed by the manufacturer	508 V		[No. cycles x 1000]	8	8	7
	635 V		[No. cycles x 1000]	8	8	6,5
	Frequency		[Oper./Hour]	30	30	30

SACE Emax 3 low voltage power circuit breakers

UL 1066

Common data

Rated maximum voltage	[V]	635
Rated voltage	[V]	600
Test voltage (1min. 50/60 Hz)	[kV]	2.2
Frequency	[Hz]	50 - 60
Number of poles		3-4
Version		Fixed (F) - Drawout (W)



SACE Emax 3 UL 1066

E2.3

Performance levels

		B-A	N-A	S-A	H-A	V-A	
Rated uninterrupted current I _u @ 40°C	[A]	1600	1600	800	800	250	
	[A]		2000	1200	1200	400	
	[A]			1600	1600	800	
	[A]			2000	2000	1200	
	[A]					1600	
	[A]					2000	
Neutral pole current-carrying capacity for 4-pole CBs	[%I _u]	100	100	100	100	100	
Interrupting rating at rated maximum voltage	254 V	[kA]	42	50	65	85	100
	508 V	[kA]	42	50	65	85	100
	635 V	[kA]	42	50	65	85	85
Rated short time current (30 cycle/0.5s)	[kA]	42	50	65	85	85	
Breaking ¹	Breaking time for I < I _{cw}	[ms]	40	40	40	40	40
	Breaking time for I > I _{cw}	[ms]	25	25	25	25	25

¹ Total clearing time is the sum of breaking time and trip time

Dimensions and weight

Dimensions	H - Fixed/Drawout	[in/mm]	14.61 [in] - 371 [mm]/16.73 [in] - 425 [mm]
	D - Fixed/Drawout	[in/mm]	10.63 [in] - 270 [mm]/15.47 [in]- 393 [mm]
	W - Fixed 3p/4p	[in/mm]	10.87 [in] -276 [mm]/ 14.41 [in] -366 [mm]
	W - Drawout 3p/4p	[in/mm]	12.48 [in] - 317 [mm]/16.02 [in] -407 [mm]
Weights (CB with trip unit/current sensors/standard accessories)	Fixed 3p/4p	[lbs/Kg]	115 [lbs] - 52 [kg]/148 [lbs] - 67 [kg]
	Drawout 3p/4p including fixed part	[lbs/Kg]	up to 1600A: 128 [lbs] -58 [kg]/150 [lbs] - 68 [Kg] ; 2000A: 135 [lbs] - 61 [kg]/239 [lbs] - 108 [kg]

SACE Emax 3 UL 1066

E2.3

Mechanical life with regular ordinary maintenance prescribed by the manufacturer	[I _u]	[A]	<1600	1600	2000
		[No. cycles x 1000]	25	25	25
	Frequency	[Oper./Hour]	60	60	60
Electrical life with regular ordinary maintenance prescribed by the manufacturer	508 V	[No. cycles x 1000]	15	12	10
	635 V	[No. cycles x 1000]	15	10	8
	Frequency	[Oper./Hour]	30	30	30

SACE Emax 3 low voltage power circuit breakers

UL 1066

Common data

Rated maximum voltage	[V]	635
Rated voltage	[V]	600
Test voltage (1min. 50/60 Hz)	[kV]	2.2
Frequency	[Hz]	50 - 60
Number of poles		3-4
Version		Fixed (F) - Drawout (W)



SACE Emax 3 UL 1066

E4.3

Performance levels

			S-A	H-A	V-A
Rated uninterrupted current I _u @ 40°C		[A]	2500	2500	800
		[A]	3000	3000	1600
		[A]	3200	3200	2000
		[A]			2500
		[A]			3000
		[A]			3200
		[A]			
Neutral pole current-carrying capacity for 4-pole CBs		[%I _u]	100	100	100
Interrupting rating at rated maximum voltage	254 V	[kA]	65	85	100
	508 V	[kA]	65	85	100
	635 V	[kA]	65	85	100
Rated short time current (30 cycle/0.5s)		[kA]	65	85	100
Breaking (1)	Breaking time for I < I _{cw}	[ms]	40	40	40
	Breaking time for I > I _{cw}	[ms]	25	25	25

¹ Total clearing time is the sum of breaking time and trip time

Dimensions and weight

Dimensions	H - Fixed/Drawout	[in/mm]	14.61 [in] - 371 [mm]/16.73 [in] - 425 [mm]
	D - Fixed/Drawout	[in/mm]	10.63 [in] - 270 [mm]/ 15.47 [in]-393 [mm]
	W - Fixed 3p/4p	[in/mm]	15.12[in] - 384 [mm]/20.08 [in]-510 [mm]
	W - Drawout 3p/4p	[in/mm]	16.73 [in] - 425/[mm]/21.69 [in] -551 [mm]
Weights (CB with trip unit/current sensors/standard accessories)	Fixed 3p/4p	[lbs/Kg]	Up to 2500A: 161[lbs] - 73 [kg]/203 [lbs] - 92 [kg]; 3200A: 201[lbs]-91 [kg]/256 [lbs] -116 [kg] ; 3600A: 210 [lbs] - 95 [kg]
	Drawout 3p/4p including fixed part	[lbs/Kg]	Up to 2500A: 261 [lbs]-118 [kg]/325 [lbs] - 147 [kg]; 3200A: 300 [lbs]- 136 [kg]/377 [lbs] - 171 [kg]

SACE Emax 3 UL 1066

E4.3

Mechanical life with regular ordinary maintenance prescribed by the manufacturer		[I _u]	[A]	< 800	800	1200
			[No. cycles x 1000]	20	20	20
		Frequency	[Oper./Hour]	60	60	60
Electrical life with regular ordinary maintenance prescribed by the manufacturer	508 V		[No. cycles x 1000]	8	8	7
	635 V		[No. cycles x 1000]	8	8	6,5
		Frequency	[Oper./Hour]	30	30	30

SACE Emax 3 low voltage power circuit breakers

UL 1066

Common data

Rated maximum voltage	[V]	635
Rated voltage	[V]	600
Test voltage (1min. 50/60 Hz)	[kV]	2.2
Frequency	[Hz]	50 - 60
Number of poles		3-4
Version		Fixed (F) - Drawout (W)



SACE Emax 3 UL 1066

E6.3

Performance levels

			H-A	V-A
Rated uninterrupted current I _u @ 40°C		[A]	4000	4000
		[A]	5000	5000
		[A]	6000 ¹	6000 ¹
Neutral pole current-carrying capacity for 4-pole CBs		[%I _u]	50-100	50-100
Interrupting rating at rated maximum voltage	254 V	[kA]	85	100
	508 V	[kA]	85	100
	635 V	[kA]	85	100
Rated short time current (30 cycle/0.5s)		[kA]	85	100
Breaking ²	Breaking time for I < I _{cw}	[ms]	40	40
	Breaking time for I > I _{cw}	[ms]	25	25

¹ 3 poles and draw out only - Overall dimension as 4 poles full size

² Total clearing time is the sum of breaking time and trip time

Dimensions and weight

Dimensions	H - Fixed/Drawout	[in/mm]	14.61 [in] - 371 [mm]/16.73 [in]- 425 [mm]
	D - Fixed/Drawout	[in/mm]	10.63 [in]- 270 [mm]/ 15.47 [in]-393 [mm]
	W - Fixed 3p/4p/4p full size	[in/mm]	30 [in]-762[mm]/34.96 [in] - 888 [mm]/39.92 [in] - 1014 [mm]
	W - Drawout 3p/4p/4p full size	[in/mm]	31.61 [in] - 803[mm]/36.57 [in] - 929 [mm]/ 42.09 [in] - 1069 [mm]
Weights (CB with trip unit/current sensors/standard accessories)	Fixed 3p/4p/4p full size	[lbs/Kg]	314 [lbs]- 142 [kg]/360 [lbs]-163 [kg]/ 406 [lbs] - 184 [kg]
	Drawout 3p/4p/4p full size including fixed part	[lbs/Kg]	Up to 5000A: 486 [lbs]-220 [kg]/ 554 [lbs]-251 [kg]/620 [lbs] -281 [kg] 6000A: 818 [lbs] - 371 [kg]

SACE Emax 3 UL 1066

E6.3

Mechanical life with regular ordinary maintenance prescribed by the manufacturer		[I _u]	[A]	4000	5000	6000
			[No. cycles x 1000]	12	12	12
		Frequency	[Oper./Hour]	60	60	60
Electrical life with regular ordinary maintenance prescribed by the manufacturer	508 V		[No. cycles x 1000]	4	3	2
	635 V		[No. cycles x 1000]	4	2	2
		Frequency	[Oper./Hour]	10	10	10

SACE Emax 3 low voltage power circuit breakers

Switch disconnectors UL 1066

Common data

Rated maximum voltage	[V]	635
Rated voltage	[V]	600
Test voltage (1min. 50/60 Hz)	[kV]	2.2
Frequency	[Hz]	50 - 60
Number of poles		3- 4 - 4/f
Version		Fixed (F) - Drawout (W)



Frame		E1.3	E2.3		E4.3			E6.3		
Performance levels		B-A	N-A	N-A	S-A	V-A	S-A	H-A	V-A	L-A
Rated uninterrupted current I _u @ 40°C	[A]	800	800	1600	800	800	2500	2500	800	4000
	[A]	1200	1200	2000	1600	1600	3200	3200	1600	5000
	[A]				2000	2000			2000	6000 ¹
Neutral pole current-carrying capacity for 4-pole CBs	[%I _u]	100	100	100	100	100	100	100	100	50-100
Rated short time current (30 cycle/0.5s)	[kA]	42	50	50	65	65	65	85	100	100

¹ 3 poles and draw out only - Overall dimension as 4 poles full size

Dimensions and weight			E1.3	E2.3	E4.3	E6.3
Dimensions	H - Fixed/Drawout	[in/mm]	11.65 [in] - 296 [mm]/ 14.33 [in] - 363.5 [mm]	14.61 [in] - 371 [mm]/ 16.73 [in] - 425 [mm]	14.61 [in] - 371 [mm]/ 16.73 [in] - 425 [mm]	14.61 [in] - 371 [mm]/ 16.73 [in] - 425 [mm]
		D - Fixed/Drawout	[in/mm]	7.20 [in] - 183 [mm]/ 11.06 [in] - 281 [mm]	10.63 [in] - 270 [mm]/ 15.47 [in] - 393 [mm]	10.63 [in] - 270 [mm]/ 15.47 [in] - 393 [mm]
	W - Fixed 3p/4p	[in/mm]	8.27 [in] - 210 [mm]/ 11.02 [in] - 280 [mm]	10.87 [in] - 276 [mm]/ 14.41 [in] - 366 [mm]	15.12 [in] - 384 [mm]/ 20.08 [in] - 510 [mm]	30 [in] - 762 [mm]/ 34.96 [in] - 888 [mm]/ 39.92 [in] - 1014 [mm]
		W - Drawout 3p/4p	[in/mm]	10.94 [in] - 278 [mm]/ 13.70 [in] - 348 [mm]	12.48 [in] - 317 [mm]/ 16.02 [in] - 407 [mm]	16.73 [in] - 425 [mm]/ 21.69 [in] - 551 [mm]
Weights (CB with trip unit/current sensors/standard accessories)	Fixed 3p/4p	[lbs/Kg]	30.9 [lbs] - 14 [kg]/ 35.3 [lbs] - 16 [kg]	115 [lbs] - 52 [kg]/ 148 [lbs] - 67 [kg]	Up to 2500A: 161 [lbs] - 73 [kg]/ 203 [lbs] - 92 [kg]; 3200A: 201 [lbs] - 91 [kg] / 256 [lbs] - 116 [kg]; 3600A: 210 [lbs] - 95 [kg]	314 [lbs] - 142 [kg]/ 360 [lbs] - 163 [kg]/ 406 [lbs] - 184 [kg]
	Drawout 3p/4p including fixed part	[lbs/Kg]	90.4 [lbs] - 41 [kg]/ 102.5 [lbs] - 46.5 [kg]	up to 1600A: 128 [lbs] - 58 [kg]/ 150 [lbs] - 68 [kg]; 2000A: 135 [lbs] - 61 [kg]/ 239 [lbs] - 108 [kg]	Up to 2500A: 261 [lbs] - 118 [kg]/ 325 [lbs] - 147 [kg]; 3200A: 300 [lbs] - 136 [kg]/ 377 [lbs] - 171 [kg]	Up to 5000A: 486 [lbs] - 220 [kg]/ 554 [lbs] - 251 [kg]/ 620 [lbs] - 281 [kg] 6000A: 818 [lbs] - 371 [kg]

Electrical and mechanical life

FRAME			E1.3		E2.3			E4.3			E6.3				
Mechanical life with regular ordinary maintenance prescribed by the manufacturer	[I _u]	[A]	< 800	800	1200	<1600	1600	2000	<2500	2500	3200	3600	4000	5000	6000
		[No. cycles x 1000]	20	20	20	25	25	25	20	20	20	20	12	12	12
	Frequency	[Oper./Hour]	60	60	60	60	60	60	60	60	60	60	60	60	60
Electrical life with regular ordinary maintenance prescribed by the manufacturer	508 V	[No. cycles x 1000]	8	8	7	15	12	10	10	8	7	7	4	3	2
		[No. cycles x 1000]	8	8	6,5	15	10	8	10	8	7	7	4	2	2
	Frequency	[Oper./Hour]	30	30	30	30	30	30	20	20	20	20	10	10	10

SACE Emax 3 low voltage power circuit breakers

Multi-standard version

IEC 60947, UL1066 and CCC

Common data		
Rated maximum voltage	[V]	635
Rated voltage	[V]	600
Test voltage (1min. 50/60 Hz)	[kV]	2.2
Frequency	[Hz]	50 - 60
Number of poles		3-4
Version		Fixed (F) - Drawout (W)
Isolation behaviour		IEC 60947-2

Frame	E2.3				E4.3				E6.3	
	N-A	S-A	H-A	V-A	S-A	H-A	V-A	V-A	V-A	
Performance levels	Rated uninterrupted current I _u @ 40°C	[A]	1600	800	800	250	2500	2500	800	4000
		[A]	2000	1200	1200	400	3000	3000	1600	5000
		[A]		1600	1600	800	3200	3200	2000	6000 ¹
		[A]		2000	2000	1200			2500	
		[A]				1600			3000	
		[A]				2000			3200	
		[A]								
Neutral pole current-carrying capacity for 4-pole CBs	[%I _u]	100	100	100	100	100	100	100	50-100	
Interrupting rating at rated maximum voltage	254 V	[kA]	50	65	85	100	65	85	100	100
	508 V	[kA]	50	65	85	100	65	85	100	100
	635 V	[kA]	50	65	85	85	65	85	100	100
Rated short time current (30 cycle/0.5s)	[kA]	50	65	85	85	65	85	100	100	

¹ 3-poles and draw out only - Overall dimension as 4 poles full size
 Note: Drawout versions utilize standard UL cradles/fixed parts

Dimensions and weight		E2.3		E4.3		E6.3	
Dimensions	H - Fixed/Drawout	[in/mm]	14.61 [in] - 371 [mm]/ 16.73 [in] - 425 [mm]	14.61 [in] - 371 [mm]/ 16.73 [in] - 425 [mm]	14.61 [in] - 371 [mm]/ 16.73 [in] - 425 [mm]	14.61 [in] - 371 [mm]/ 16.73 [in] - 425 [mm]	14.61 [in] - 371 [mm]/ 16.73 [in] - 425 [mm]
	D - Fixed/Drawout	[in/mm]	10.63 [in] - 270 [mm]/ 15.47 [in] - 393 [mm]	10.63 [in] - 270 [mm]/ 15.47 [in] - 393 [mm]	10.63 [in] - 270 [mm]/ 15.47 [in] - 393 [mm]	10.63 [in] - 270 [mm]/ 15.47 [in] - 393 [mm]	10.63 [in] - 270 [mm]/ 15.47 [in] - 393 [mm]
	W - Fixed 3p/4p	[in/mm]	10.87 [in] - 276 [mm]/ 14.41 [in] - 366 [mm]	15.12 [in] - 384 [mm]/ 20.08 [in] - 510 [mm]	15.12 [in] - 384 [mm]/ 20.08 [in] - 510 [mm]	30 [in] - 762 [mm]/ 34.96 [in] - 888 [mm]/ 39.92 [in] - 1014 [mm]	30 [in] - 762 [mm]/ 34.96 [in] - 888 [mm]/ 39.92 [in] - 1014 [mm]
	W - Drawout 3p/4p	[in/mm]	12.48 [in] - 317 [mm]/ 16.02 [in] - 407 [mm]	16.73 [in] - 425 [mm]/ 21.69 [in] - 551 [mm]	16.73 [in] - 425 [mm]/ 21.69 [in] - 551 [mm]	31.61 [in] - 803 [mm]/ 36.57 [in] - 929 [mm]/ 42.09 [in] - 1069 [mm]	31.61 [in] - 803 [mm]/ 36.57 [in] - 929 [mm]/ 42.09 [in] - 1069 [mm]
Weights (CB with trip unit/ current sensors/ standard accessories)	Fixed 3p/4p	[lbs/Kg]	115 [lbs] - 52 [kg]/ 148 [lbs] - 67 [kg]	Up to 2500A: 161 [lbs] - 73 [kg]/ 203 [lbs] - 92 [kg]; 3200A: 201 [lbs] - 91 [kg]/256 [lbs] -116 [kg]; 3600A: 210 [lbs] - 95 [kg]	Up to 2500A: 161 [lbs] - 73 [kg]/ 203 [lbs] - 92 [kg]; 3200A: 201 [lbs] - 91 [kg]/256 [lbs] -116 [kg]; 3600A: 210 [lbs] - 95 [kg]	314 [lbs] - 142 [kg]/360 [lbs] - 163 [kg]/406 [lbs] - 184 [kg]	314 [lbs] - 142 [kg]/360 [lbs] - 163 [kg]/406 [lbs] - 184 [kg]
	Drawout 3p/4p including fixed part	[lbs/Kg]	up to 1600A: 128 [lbs] - 58 [kg]/ 150 [lbs] - 68 [kg]; 2000A: 135 [lbs] - 61 [kg]/ 239 [lbs] - 108 [kg]	Up to 2500A: 261 [lbs] - 118 [kg]/ 325 [lbs] - 147 [kg]; 3200A: 300 [lbs] - 136 [kg]/ 377 [lbs] - 171 [kg]	Up to 2500A: 261 [lbs] - 118 [kg]/ 325 [lbs] - 147 [kg]; 3200A: 300 [lbs] - 136 [kg]/ 377 [lbs] - 171 [kg]	Up to 5000A: 486 [lbs] - 220 [kg]/554 [lbs] - 251 [kg]/ 620 [lbs] - 281 [kg]	Up to 5000A: 486 [lbs] - 220 [kg]/554 [lbs] - 251 [kg]/ 620 [lbs] - 281 [kg]

Electrical and mechanical life

FRAME	E1.3		E4.3								
	[lu]	[A]	< 800	800	1200	1600	2000	<2500	2500	3200	5000
Mechanical life with regular ordinary maintenance prescribed by the manufacturer		[No. cycles x 1000]	20	20	20	25	25	20	20	20	12
	Frequency	[Oper./Hour]	60	60	60	60	60	60	60	60	60
	Electrical life with regular ordinary maintenance prescribed by the manufacturer	508 V	[No. cycles x 1000]	8	8	7	12	10	10	8	7
	635 V	[No. cycles x 1000]	8	8	6,5	10	8	10	8	7	2
	Frequency	[Oper./Hour]	30	30	30	30	30	20	20	20	10

SACE Emax 3 low voltage power circuit breakers

Instructions for ordering

SACE Emax 3 configured circuit breaker/switch disconnect order code breakdown

1	2	3	4	5	6	7 & 8	9	10	11	12	13	14	15	16	17	18	19	20	21	22	23	24	25	26	27	28	29	30
---	---	---	---	---	---	-------	---	----	----	----	----	----	----	----	----	----	----	----	----	----	----	----	----	----	----	----	----	----

1 - Emax 3 Prefix

Emax 3	E
---------------	---

2 - Frame

	E1.3	E2.3	E4.3	E5.3	E6.3	E6.3/f
3p	1	2	4	5	6	-
4p - N Left	A	B	C		D	E
4p - N Right	F	G	H		J	K

Default 4p configuration is on the left
E6.3/f = 100% rated neutral

3 - Short Circuit Rating / Performance

	B	C	N	S	H	V	L	X
508V AC	42	-	50	65	85	100	-	-
635V AC	42	-	50	65	85	85/100	-	-
440V AC	42	50	66	85	100	150	-	150
690V AC	42	42	66	66	85/100	100	-	100

4 - Version/Certification

A	3	R	L	D	C
UL1066 (OEM)	UL1066 + Non-defeatable I Protection	ReliaGear SB Drawout (Replacement)	UL/IEC/CCC (Triple Cert.)	UL/IEC (Dual Cert.)	IEC

5 - Frame/Sensor Rating

	A	B	C	D	E	F	G	H	J	K	L	M	N	P	Q
UL [A]	250	400	-	800	1000	1200	1600	2000	2500	3000	3200	3600	4000	5000	6000
IEC [A]	250	400	630	800	1000	1250	1600	2000	2500	-	3200	-	4000	5000	6300

6 - Digital Rating Plug

	1	2	A	B	C	D	E	F	G	H	J	K	L	M	N	P	Q
UL [A]	100	200	250	400	600	800	1000	1200	1600	2000	2500	3000	3200	3600	4000	5000	6000
IEC [A]	100	200	250	400	630	800	1000	1250	1600	2000	2500	3000	3200	3600	4000	5000	6300

SACE Emax 3 low voltage power circuit breakers

Instructions for ordering

SACE Emax 3 configured circuit breaker/switch disconnect order code breakdown

1	2	3	4	5	6	7 & 8	9	10	11	12	13	14	15	16	17	18	19	20	21	22	23	24	25	26	27	28	29	30
---	---	---	---	---	---	-------	---	----	----	----	----	----	----	----	----	----	----	----	----	----	----	----	----	----	----	----	----	----

7 & 8 - Mounting & Terminals

	7	8
Drawout	M	P
Drawout Embedded RRD	R	R
	Fixed Mount - Upper Terminals	Fixed Mount - Lower Terminals
HR	H	H
VR	V	V
LHR-Multi	A	A
LVR-Multi	B	B
SHR-Single	C	C
SVR-Single	D	D
SHR-Multi	G	G
SVR-Multi	J	J
F	F	F
EF	E	E
ES	S	S
FCCUAL	L	L

10 - Measurement Hardware & Communication Accessories

NONE (Switch disconnecter only)	X
Measurement Hardware Placement	
Measurement Hardware Lower Terminals ¹	A
Measurement Hardware Upper Terminals	B
Measurement Hardware External Cables	C
Add Trip Unit Supply from Busbars	
Measurement Hardware Lower Terminals ¹ + Busbar Supply	D
Measurement Hardware Upper Terminals + Busbar Supply	E
Measurement Hardware External Cables + Busbar Supply	F
Add Ekip RTC to monitor Ready to Close Status via Communications	
Measurement Hardware Lower Terminals ¹ + Ekip RTC	G
Measurement Hardware Upper Terminals + Ekip RTC	H
Measurement Hardware External Cables + Ekip RTC	J
Additional Combinations	
Measurement Hardware Lower Terminals ¹ + Busbar Supply + Ekip RTC	K
Measurement Hardware Upper Terminals + Busbar Supply + Ekip RTC	L
Measurement Hardware External Cables + Busbar Supply + Ekip RTC	M

¹ Provided as default with base circuit breaker

9 - Basic Protections & Trip Unit Options

Switch disconnecter	X
Ekip Aware	
LI	A
LSI	B
LSIG	C
No Wireless Connectivity	
LI	D
LSI	E
LSIG	F
Sealable Trip Unit Cover	
LI	G
LSI	H
LSIG	J
No Wireless + Sealable TU Cover	
LI	K
LSI	L
LSIG	M
Ekip Aware Cybersecurity IEC 62443-4-2	
LI	N
LSI	P
LSIG	Q
No Wireless Connectivity	
LI	R
LSI	S
LSIG	T
Sealable Trip Unit Cover	
LI	U
LSI	V
LSIG	Q
No Wireless + Sealable TU Cover	
LI	W
LSI	Y
LSIG	Z

SACE Emax 3 low voltage power circuit breakers

Instructions for ordering

SACE Emax 3 configured circuit breaker/switch disconnecter order code breakdown

1 2 3 4 5 6 7 & 8 9 10 11 12 13 14 15 16 17 18 19 20 21 22 23 24 25 26 27 28 29 30

11 - Auxiliary Contacts - Circuit Breaker Status

None (Switch disconnecter only)	X
Standard Supply	
AUX 4Q 400VAC* + Bell Alarm 250V (S51) ^{(1) (2)}	A
Optional Combinations	
AUX 4Q 400VAC* + Bell Alarm 24VDC (S51)	B
AUX 4Q 24VDC + Bell Alarm 250V (S51) ^{(1) (2)}	C
AUX 4Q 24VDC + Bell Alarm 24VDC (S51)	D
Mixed Voltages	
AUX 2Q 400V + 2Q 24VDC + Bell Alarm 250V ^{(1) (2)}	E
AUX 2Q 400V + 2Q 24VDC + Bell Alarm 24VDC	F
5 Pin Terminal Blocks For Electrical Accessories	
AUX 4Q 400VAC* + Bell Alarm 250V (S51) ^{(1) (2)}	G
Optional Combinations	
AUX 4Q 400VAC* + Bell Alarm 24VDC (S51)	H
AUX 4Q 24VDC + Bell Alarm 250V (S51) ^{(1) (2)}	J
AUX 4Q 24VDC + Bell Alarm 24VDC (S51)	K
Mixed Voltages	
AUX 2Q 400V + 2Q 24VDC + Bell Alarm 250V ^{(1) (2)}	L
AUX 2Q 400V + 2Q 24VDC + Bell Alarm 24VDC	M

1) Provided as default with base circuit breaker

2) Bell Alarm not available for Switch Disconnecter versions

12 - Additional Auxiliary Contacts & Signalling I/O

None	X
Additional AUX 6Q Contacts	
AUX 6Q 400Vac	A
AUX 6Q 24Vdc	D
AUX 3Q 400Vac + 3Q 24Vdc	C
Additional Signalling I/O's	
Ekip Signalling 4K	4
M-Sense Enabler - Motor	
M-Sense Enabler 100V-415V	F
M-Sense Enabler 24V-60V	E

13 - Module 1

None	X
Ekip Supply Lite	S
Ekip supply Evo Modbus TCP	E
Ekip Supply Evo + Module 1	
Communications	
Ekip Com Modbus RS-485	A
Ekip Com Ethernet/Ip	B
Ekip Com IEC61850	C
Ekip Com Profibus	D
Ekip Com Profinet	F
Other Modules	
Ekip RELT	G
Ekip Signalling 2k	H
Ekip Synchrocheck	J
Ekip Signalling 4T	K
Ekip Arc-Flash 6F	L
Ekip Supply Lite + Module 1	
Communications	
Ekip Com Modbus RS-485	M
Ekip Com Profibus	N
Other Modules	
Ekip RELT	P
Ekip Signalling 2k	Q
Ekip Synchrocheck	R
Ekip Signalling 4T	T
Ekip Arc-Flash 6F	U

SACE Emax 3 low voltage power circuit breakers

Instructions for ordering

SACE Emax 3 configured circuit breaker/switch disconnect order code breakdown

- 1
- 2
- 3
- 4
- 5
- 6
- 7 & 8
- 9
- 10
- 11
- 12
- 13
- 14
- 15
- 16
- 17
- 18
- 19
- 20
- 21
- 22
- 23
- 24
- 25
- 26
- 27
- 28
- 29
- 30

14 - Module 2

None	X
Communications	
Ekip Com Modbus RS-485	A
Ekip Com Ethernet/Ip	B
Ekip Com IEC61850	C
Ekip Com Profibus	D
Ekip Com Profinet	F
Other Modules	
Ekip RELT	G
Ekip Signalling 2k	H
Ekip Synchrocheck	J
Ekip Signalling 4T-1	K
Ekip Arc-Flash 6F	L

15 - Module 3

None	X
Communications	
Ekip Com Modbus RS-485	A
Ekip Com Profibus	D
Other Modules	
Ekip RELT	G
Ekip Synchrocheck	H
Ekip Signalling 4T-1	K
Ekip Arc-Flash 6F	L

16 - Opening Coil & Second UVR

None	X
Opening coil (YO1)	
110-120 Vac/dc	A
120-127 Vac/dc	B
220-240 Vac/dc	C
24 Vac/dc	D
240-250 Vac/dc	E
30 Vac/dc	F
380-400 Vac	G
415-440 Vac	H
48 Vac/dc	J
480-500 Vac	K
60 Vac/dc	L
Opening coil - Sense - (YO1-S)	
YO-1 Sense 110-250 Vac/dc	M
YO-1 Sense 24-60 Vac/dc	N
Second Undervoltage Release (YU2)	
YU 110-120 Vac/dc	O
YU 120-127 Vac/dc	P
YU 220-240 Vac/dc	Q
YU 24 Vac/dc	R
YU 240-250 Vac/dc	S
YU 30 Vac/dc	T
YU 380-400 Vac	U
YU 415-440 Vac	V
YU 48 Vac/dc	W
YU 480-500 Vac	Y
YU 60 Vac/dc	Z
Second Undervoltage Release - Sense (YU2-S)	
YU-2 Sense 110-120 Vac/dc	2
YU-2 Sense 120-127 Vac/dc	3
YU-2 Sense 220-240 Vac/dc	4
YU-2 Sense 24 Vac/dc	5
YU-2 Sense 240-250 Vac/dc	6
YU-2 Sense 30 Vac/dc	7
YU-2 Sense 48 Vac/dc	8
YU-2 Sense 60 Vac/dc	9

SACE Emax 3 low voltage power circuit breakers

Instructions for ordering

SACE Emax 3 configured circuit breaker/switch disconnect order code breakdown

1 2 3 4 5 6 7 & 8 9 10 11 12 13 14 15 16 17 18 19 20 21 22 23 24 25 26 27 28 29 30

17 - Closing Coil 1

None	X
Closing coil (YC1)	
YC 110-120 Vac/dc	A
YC 120-127 Vac/dc	B
YC 220-240 Vac/dc	C
YC 24 Vac/dc	D
YC 240-250 Vac/dc	E
YC 30 Vac/dc	F
YC 380-400 Vac	G
YC 415-440 Vac	H
YC 48 Vac/dc	J
YC 480-500 Vac	K
YC 60 Vac/dc	L
Closing coil - Sense (YC-S)	
YC Sense 110-250 Vac/dc	M
YC Sense 24-60 Vac/dc	N

18 - Closing Coil 2

None	X
Close coil (YC2)¹	
YC2 110-120 Vac/dc	A
YC2 120-127 Vac/dc	B
YC2 220-240 Vac/dc	C
YC2 24 Vac/dc	D
YC2 240-250 Vac/dc	E
YC2 30 Vac/dc	F
YC2 380-400 Vac	G
YC2 415-440 Vac	H
YC2 48 Vac/dc	J
YC2 480-500 Vac	K
YC2 60 Vac/dc	L
Closing coil - Sense (YC2-S)	
YC2-Sense 110-250 Vac/dc	M
YC2-Sense 24-60 Vac/dc	N

¹ E2.3 - E6.3 only

19 - Undervoltage and Second Opening Coils

None	X
Undervoltage Release (YU)	
YU 110-120 Vac/dc	A
YU 120-127 Vac/dc	B
YU 220-240 Vac/dc	C
YU 24 Vac/dc	D
YU 240-250 Vac/dc	E
YU 30 Vac/dc	F
YU 380-400 Vac	G
YU 415-440 Vac	H
YU 48 Vac/dc	J
YU 480-500 Vac	K
YU 60 Vac/dc	L
Undervoltage Release - Sense (YU-S)	
YU-Sense 110-120 Vac/dc	M
YU-Sense 120-127 Vac/dc	N
YU-Sense 220-240 Vac/dc	O
YU-Sense 24 Vac/dc	P
YU-Sense 240-250 Vac/dc	Q
YU-Sense 30 Vac/dc	R
YU-Sense 48 Vac/dc	S
YU-Sense 60 Vac/dc	T
Second opening coil (YO2)	
YO2 110-120 Vac/dc	U
YO2 120-127 Vac/dc	V
YO2 220-240 Vac/dc	W
YO2 24 Vac/dc	Y
YO2 240-250 Vac/dc	Z
YO2 30 Vac/dc	2
YO2 380-400 Vac	3
YO2 415-440 Vac	4
YO2 48 Vac/dc	5
YO2 480-500 Vac	6
YO2 60 Vac/dc	7
Second opening coil - Sense (YO2-S)	
YO2-Sense 110-250 Vac/dc	8
YO2-Sense 24-60 Vac/dc	9

SACE Emax 3 low voltage power circuit breakers

Instructions for ordering

SACE Emax 3 configured circuit breaker/switch disconnect order code breakdown

1	2	3	4	5	6	7 & 8	9	10	11	12	13	14	15	16	17	18	19	20	21	22	23	24	25	26	27	28	29	30
---	---	---	---	---	---	-------	---	----	----	----	----	----	----	----	----	----	----	----	----	----	----	----	----	----	----	----	----	----

20 - Spring Charging Motor & Mechanical Operations Counter

None	X
Spring Charging Motor (M)	
M 100-130 VAC/DC	A
M 220-250 VAC/DC	B
M 24-30 VAC/DC	C
M 24-30 VAC/DC + MC 24V	D
M 277 VAC	E
M 277 VAC + MC 24V	F
M 380-415 VAC	G
M 380-415 VAC + MC 24V	H
M 48-60 VAC/DC	J
M 48-60 VAC/DC + MC 24V	K
M 440-480 VAC	L
M 100-130 VAC/DC + MC 24V	M
M 220-250 VAC/DC + MC 24V	N
M 440-480 VAC + MC 24V	P
Mechanical Counter (MOC)	
Spring Charging Motor + MOC	
M 100-130 VAC/DC	R
M 220-250 VAC/DC	S
M 24-30 VAC/DC	T
M 24-30 VAC/DC + MC 24V	U
M 277 VAC	V
M 277 VAC + MC 24V	W
M 380-415 VAC	Y
M 380-415 VAC + MC 24V	Z
M 48-60 VAC/DC	2
M 48-60 VAC/DC + MC 24V	3
M 440-480 VAC	4
M 100-130 VAC/DC + MC 24V	5
M 220-250 VAC/DC + MC 24V	6
M 440-480 VAC + MC 24V	7

21 - Ready to Close (RTC), Remote Reset of Tripped Flag (YR), 2nd Bell Alarm (S51/2)

None	X
Ready to Close (RTC)	
RTC 250Vac	A
RTC 24Vdc	B
Remote Reset of Tripped Flag (YR)	
YR 110 VAC/DC	C
YR 24 VDC	D
YR 250 VAC/DC	E
Second Bell Alarm (S51/2)⁽¹⁾	
2nd Bell Alarm 250V (S51/2)	F
2nd Bell Alarm 24VDC (S51/2)	G
Optional Combinations	
RTC 250Vac + YR 110 VAC/DC	H
RTC 24Vdc + YR 110 VAC/DC	J
RTC 250Vac + YR 24 VDC	K
RTC 24Vdc + YR 24 VDC	L
RTC 250Vac + YR 250 VAC/DC	M
RTC 24Vdc + YR 250 VAC/DC	N
RTC 250Vac + 2nd Bell Alarm 250V (S51/2)	P
RTC 24Vdc + 2nd Bell Alarm 250V (S51/2)	Q
RTC 250Vac + 2nd Bell Alarm 24VDC (S51/2)	R
RTC 24Vdc + 2nd Bell Alarm 24VDC (S51/2)	S

1) S51/2 uses the same housing as YR

SACE Emax 3 low voltage power circuit breakers

Instructions for ordering

SACE Emax 3 configured circuit breaker/switch disconnect order code breakdown

1 2 3 4 5 6 7 & 8 9 10 11 12 13 14 15 16 17 18 19 20 21 22 23 24 25 26 27 28 29 30

23 - 1st & 2nd Padlock or Keylock Devices

None	X
Padlock in Open Position (PLC) 1st/Left	P
Keylock in Open Position (KLC) 1st/Right	
KLC-S 1st/Right No. 20005	S
KLC-D 1st/Right Random No. 20005-8	D
KLC-D Ronis 1st/Right	R
KLC-A Kirk-STI -1st/Right	K
KLC-A Castell-1st/Right	C
Padlock & Keylock Combinations	
PLC 1st/Left + PLC 2nd/Right	L
PLC 1st/Left + KLC-S 1st/Right No. 20005	A
PLC 1st/Left + KLC-D 1st/Right Random No. 20005-8	B
PLC 1st/Left + KLC-D Ronis 1st/Right	E
PLC 1st/Left + KLC-A Kirk-STI -1st/Right	F
PLC 1st/Left + KLC-A Castell-1st/Right	G
Dual Keylock Combinations	
KLC-S 1st/Right No. 20005 + KLC-D 2nd/Left Random No. H 20005-8	H
KLC-D 1st/Right Random No. 20005-8 + KLC-D 2nd/Left Random No. 20005-8	J
KLC-D Ronis 1st/Right + KLC-D Ronis 2nd/Left ¹	M
KLC-A Kirk-STI -1st/Right + KLC-A Kirk-STI -2nd/Left ¹	2

¹ E2.3 - E6.3 only

24 - Padlock & Keylock for Racked-in/Test/Out Position for E2.3-E6.3 Only

None	X
Padlock in Racked-In/Test/Out Position (PLP)	P
Keylock in Racked-In/Test/Out Position (KLP-S) - Keyed the Same	
KLP-S Pos.lock N.20005 1key	S
Keylock in Racked-In/Test/Out Position (KLP-D) - Random keys (N200005-8)	
KLP-D Pos.lock 1Key	D
3rd Party Keylock Provisions (KLP-A)	
KLP-A Keylock in Open Position Kirk-STI	K
KLP-A Keylock in Open Position Castell	C
KLP-D Keylock Ronis	R
Additional Combinations	
Padlock in Racked-In/Test/Out Position (PLP) + KLP-S Pos.lock N.20005 1key	A
Padlock in Racked-In/Test/Out Position (PLP) + KLP-D Pos.lock 1Key	B
Padlock in Racked-In/Test/Out Position (PLP) + KLP-A Keylock in Open Position Kirk-STI	E
Padlock in Racked-In/Test/Out Position (PLP) + KLP-A Keylock in Open Position Castell	F
Padlock in Racked-In/Test/Out Position (PLP) + KLP-D Keylock Ronis	G
KLP-D Pos.lock 1Key + KLP-D Pos.lock 2Key	H
KLP-A Keylock in Open Position Kirk-STI + 2nd KLP-A Keylock in Open Position Kirk-STI	2
KLP-D Keylock Ronis + KLP-D Keylock Ronis	J

SACE Emax 3 low voltage power circuit breakers

Instructions for ordering

SACE Emax 3 configured circuit breaker/switch disconnect order code breakdown

1	2	3	4	5	6	7 & 8	9	10	11	12	13	14	15	16	17	18	19	20	21	22	23	24	25	26	27	28	29	30
---	---	---	---	---	---	-------	---	----	----	----	----	----	----	----	----	----	----	----	----	----	----	----	----	----	----	----	----	----

25 - Factory Warranty & Test Reports

None	X
Warranty Extension (Total Years)	
2 Years	A
3 Years	B
4 Years	C
5 Years	D
Factory Test Reports	
Factory Test Report	E
Factory Test Report with Pole Resistance	F
Additional Combinations	
2 Years + Factory Test Report	G
3 Years + Factory Test Report	H
4 Years + Factory Test Report	J
5 Years + Factory Test Report	K
2 Years + Factory Test Report with Pole Resistance	L
3 Years + Factory Test Report with Pole Resistance	M
4 Years + Factory Test Report with Pole Resistance	N
5 Years + Factory Test Report with Pole Resistance	P

26 - Trip Unit Features 1

None	X
Metering/Measurement Digital upgrades	
2% Measuring Digital upgrade	2
1% Accuracy Measuring Digital upgrade ²	1
0.5% Accuracy Measuring Digital upgrade ²	5
Power Quality	
Network Analyzer ¹	A
Datalogger PRO ¹	D
Additional Combinations	
Network Analyzer + Datalogger PRO ¹	B
1% Accuracy ² + Network Analyzer	C
1% Accuracy ² + Datalogger PRO	E
1% Accuracy ² + Network Analyzer + Datalogger PRO	F
0.5% Accuracy ² + Network Analyzer	G
0.5% Accuracy ² + Datalogger PRO	H
0.5% Accuracy ² + Network Analyzer + Datalogger PRO	J

¹ Requires minimum Measuring Digital upgrade

² Factory installed only

27 - Trip Unit Features 2

None	X
Voltage Protections	A
Voltage Protections, Adv. Voltage Protections	B
Frequency Protections	C
Power Protections	D
Advance Current Protections	E
Additional Combinations	
Voltage Protections, Frequency Protections	F
Voltage Protections, Adv. Voltage Protections, Frequency Protections	G
Voltage Protections, Power Protections	H
Voltage Protections, Adv. Voltage Protections, Power Protections	J
Voltage Protections, Advance Current Protection	K
Voltage Protections, Adv. Voltage Protections, Advance Current Protection	L
Frequency Protections, Power Protections	M
Frequency Protections, Advance Current Protection	N
Power Protections, Advance Current Protection	P
Voltage Protections, Frequency Protections, Power Protections	Q
Voltage Protections, Adv. Voltage Protections, Frequency Protections, Power Protections	R
Voltage Protections, Frequency Protections, Advance Current Protection	S
Voltage Protections, Adv. Voltage Protections, Frequency Protections, Advance Current Protection	T
Voltage Protections, Power Protections, Advance Current Protection	U
Voltage Protections, Adv. Voltage Protections, Power Protections, Advance Current Protection	V
Frequency Protections, Power Protections, Advance Current Protection	W
Voltage Protections, Frequency Protections, Power Protections, Advance Current Protection	Y
Voltage Protections, Adv. Voltage Protections, Frequency Protections, Power Protections, Advance Current Protection	Z

SACE Emax 3 low voltage power circuit breakers

Instructions for ordering

SACE Emax 3 configured circuit breaker/switch disconnect order code breakdown

1 2 3 4 5 6 7 & 8 9 10 11 12 13 14 15 16 17 18 19 20 21 22 23 24 25 26 27 28 29 30

28 - Trip Unit Features 3

None	X
Advanced MDGF	A
Ekip Link	B
Custom Logic	C
Internal Temperature Control	D
Directional Protection	E
Additional Combinations	
Advanced MDGF, Custom Logic	F
Advanced MDGF, Internal Temperature Control	G
Advanced MDGF, Directional Protection	H
Ekip Link, Custom Logic	J
Ekip Link, Internal Temperature Control	K
Ekip Link, Directional Protection	L
Custom Logic, Internal Temperature Control	M
Custom Logic, Directional Protection	N
Internal Temperature Control, Directional Protection	P
Advanced MDGF, Custom Logic, Internal Temperature Control	Q
Advanced MDGF, Custom Logic, Directional Protection	R
Advanced MDGF, Internal Temperature Control, Directional Protection	S
Ekip Link, Custom Logic, Internal Temperature Control	T
Ekip Link, Custom Logic, Directional Protection	U
Ekip Link, Internal Temperature Control, Directional Protection	V
Custom Logic, Internal Temperature Control, Directional Protection	W
Advanced MDGF, Custom Logic, Internal Temperature Control, Directional Protection	Y
Ekip Link, Custom Logic, Internal Temperature Control, Directional Protection	Z

29 - Trip Unit Features 4

None	X
Dual Settings	A
Triple Settings	B
Remote Control (EPiC)	C
Predictive Maintenance	D
Additional Combinations	
Dual Settings, Remote Control (EPiC)	E
Dual Settings, Predictive Maintenance	F
Remote Control (EPiC), Predictive Maintenance	G
Dual Settings, Remote Control (EPiC), Predictive Maintenance	H
Triple Settings, Remote Control (EPiC)	J
Triple Settings, Predictive Maintenance	K
Triple Settings, Remote Control (EPiC), Predictive Maintenance	L

30 - Trip Unit Features 5

None	X
Adaptive load shedding	A
Power Controller	B
Additional Combinations	
Adaptive load shedding + Power Controller	Z

SACE Emax 3 low voltage power circuit breakers

Instructions for ordering

SACE Emax 3 cradle (fixed part) order code breakdown

- 1
- 2
- 3
- 4
- 5
- 6
- 7
- 8
- 9
- 10
- 11

1 - Emax 3 Prefix

Emax 3	E
---------------	---

2 - Frame

	E1.3	E2.3	E4.3	E5.3	E6.3	E6.3/f
3p	1	2	4	5	6	-
4p	A	B	C		D	E

3 - Standard/Version

UL	A
IEC	C

4 & 5 - Version/Certification

UL		FRAME IEC [A] (PERFORMANCE CLASS)	
E1.3 1200A	12	E1.3 1600A	16
E2.3 2000A	20	E2.3 2000A	20
E4.3 2500A	25	E4.3 2500A	25
E4.3 3200A	32	E4.3 (N, S, H) 3200A	32
-	-	E4.3 2000 (V), 2500 (V), 3200 (V), 4000 (N, S, H, V)	40
E6.3 5000A	50	E6.3H 4000, 5000A	5H
E6.3 6000A	60	E6.3V 4000, 5000A	5V
		E6.3 4000 (X), 5000 (X), 6300 (H, V, X)	6X

6, 7 -Version/Certification

	H	V	A	B	C	D	G	J	F	E	S	L	X
Upper	HR	VR	LHR-Multi	LVR-Multi	SHR-Single	SVR-Single	SHR-Multi	SVR-Multi	F	EF	ES	FCCUAL	NONE
Lower	HR	VR	LHR-Multi	LVR-Multi	SHR-Single	SVR-Single	SHR-Multi	SVR-Multi	F	EF	ES	FCCUAL	NONE

8 - Auxiliary Position Contacts (AUP) (Left)

None	X
E1.1: 400VAC 6 Contacts (2 Conn. / 2 Test / 2 Disconn.)	A
E2.3-E6.3: 400VAC 5 Contacts (2 Conn. / 1 Test / 2 Disconn.)	
E1.3: 24VDC 6 Contacts (2 Conn. / 2 Test / 2 Disconn.)	D
E2.3-E6.3: 24VDC 5 Contacts (2 Conn. / 1 Test / 2 Disconn.)	
E2.3-E6.3: 400VAC 5 Contacts (1 Conn. / 3 Test / 1 Disconn.)	E
E2.3-E6.3: 24VDC 5 Fast Connect Contacts (2 Conn. / 1 Test / 2 Disconn.)	F
E2.3-E6.3: 400VAC 5 Fast Connect Contacts (2 Conn. / 1 Test / 2 Disconn.)	G
E2.3-E6.3: 400VAC 5 Fast Connect Contacts (1 Conn. / 3 Test / 1 Disconn.)	H

9 - Auxiliary Position Contacts (AUP) (Right)

None	X
E2.3-E6.3: 400VAC 5 Contacts (2 Conn. / 1 Test / 2 Disconn.)	A
E2.3-E6.3: 24VDC 5 Contacts (2 Conn. / 1 Test / 2 Disconn.)	D
E2.3-E6.3: 24VDC 5 Fast Connect Contacts (2 Conn. / 1 Test / 2 Disconn.)	F
E2.3-E6.3: 400VAC 5 Fast Connect Contacts (2 Conn. / 1 Test / 2 Disconn.)	G
E2.3-E6.3: 400VAC 5 Fast Connect Contacts (4 Conn. / 1 Disconn.)	H
E2.3-E6.3: 24VDC 5 Fast Connect Contacts (4 Conn. / 1 Disconn.)	J

SACE Emax 3 low voltage power circuit breakers

Instructions for ordering

SACE Emax 3 cradle (fixed part) order code breakdown

1 2 3 4 5 6 7 8 9 10 11

10 - Pre-installed Terminal Blocks for Accessories

None	X
8 Terminal blocks	A
18 Terminal blocks	B
8 Terminal blocks - 5 Pin	C
18 Terminal blocks - 5 Pin	D

11 - Padlock (PLP) & Keylock (KLP) for racked-in / test / disconnected position (E1.2 Only)

None	X
Padlock in Racked-In/Test/Out Position (PLP)	A
Keylock in Racked-In/Test/Out Position (KLP-S) - Keyed the Same	
KLP-S Pos.lock N.20005 1key	B
KLP-S Pos.lock N.20006 1Key	C
KLP-S Pos.lock N.20007 1Key	D
KLP-S Pos.lock N.20008 1Key	E
KLP-S Pos.lock N.20009 1Key	F
Keylock in Racked-In/Test/Out Position (KLP-D) - Random keys (N200005-8)	
KLP-D Pos.lock 1Key	G
3rd Party Keylock Provisions (KLP-A)	
KLP-A Keylock in Open Position Kirk-STI	H
KLP-A Keylock in Open Position Castell	J
Additional Combinations	
Padlock in Racked-In/Test/Out Position (PLP) + KLP-S Pos.lock N.20005 1key	K
Padlock in Racked-In/Test/Out Position (PLP) + KLP-S Pos.lock N.20006 1key	L
Padlock in Racked-In/Test/Out Position (PLP) + KLP-S Pos.lock N.20007 1key	M
Padlock in Racked-In/Test/Out Position (PLP) + KLP-S Pos.lock N.20008 1key	N
Padlock in Racked-In/Test/Out Position (PLP) + KLP-S Pos.lock N.20009 1key	P
Padlock in Racked-In/Test/Out Position (PLP) + KLP-D Pos.lock 1Key	Q
Padlock in Racked-In/Test/Out Position (PLP) + KLP-A Keylock in Open Position Kirk-STI	R
Padlock in Racked-In/Test/Out Position (PLP) + KLP-A Keylock in Open Position Castell	S
KLP-D Pos.lock 1Key + KLP-D Pos.lock 2Key	T
KLP-A Keylock in Open Position Kirk-STI + 2nd KLP-A Keylock in Open Position Kirk-STI	U



SACE Emax 3 low voltage power circuit breakers

Instructions for ordering

SACE Emax 3 accessories order code breakdown

Emax 3 Accessory Prefix

Kit Loose Supply	K3
Factory Installed Accessory Only	F3

Frame Compatibility

All (E1.3 - E6.3)	A
E1.3 only	1
E2.3	2
E4.3	4
E6.3	6
E2.3 - E6.3	B

Accessory Category

Electrical Accessories	ELEC
Aux Contacts	AUX
Drawout Position Contacts	AUP
Com Related Accessories	COM
Ekip Accessories	EK
Mechanical Accessories	MECH
Software	SW
Software - ABB Marketplace	SWMP

SACE Emax 3 low voltage power circuit breakers

General information

Abbreviations used for the description of the product

Versions and terminals

F	Fixed circuit-breaker
W	Drawout circuit-breaker
MP	Mobile part of drawout circuit-breaker
FP	Fixed part (cradle) of draw-out circuit breaker
I_u	Rated uninterrupted current
I_n	Rated current of the digital rating plug
I_{cu}	Rated ultimate short-circuit breaking capacity
I_{cw}	Rated short-time withstand current
/MS	Switch-disconnector
/f	Four-pole circuit-breakers with neutral pole at 100%
CS	Sectionalizing truck
MT	Earthing truck
MTP	Earthing switch with making capacity
HR VR	Rear orientable terminals
SHR	Horizontal rear spread terminals
SVR	Vertical rear spread terminals
F	Front terminals
FL	Flat terminals
EF	Extended front terminals
ES	Front spread terminals
Fc CuAl	Terminals for cables

Protection trip unit and functions

Ekip Aware	Measurement and protection trip unit for power distribution
L	Overload protection
S	Short-time overcurrent protection
I	Instantaneous overcurrent protection
G	Ground fault protection
Rc	Residual current protection

SACE Emax 3 low voltage power circuit breakers

Automatic circuit-breakers

Fixed version for power distribution



SACE Emax E1.3B-A/N-A • Front terminals (F)

Size	Frame Amps	Int. Rating (kA@508V)	Withstand (kA)	Type	3P		4P	
					Global PN	US / CA PN	Global PN	US / CA PN
E1.3B-A	800	42	42	E1.3B-A 800 Ekip Aware LI	1SDA126653R1	E1BADDFFAAA	1SDA126669R1	EABADDFFAAA
				E1.3B-A 800 Ekip Aware LSI	1SDA126654R1	E1BADDFFBAA	1SDA126670R1	EABADDFFBAA
				E1.3B-A 800 Ekip Aware LSIG	1SDA129043R1	E1BADDFFCAA	1SDA129051R1	EABADDFFCAA
	1200	42	42	E1.3B-A 1200 Ekip Aware LI	1SDA126655R1	E1BAFFFFAAA	1SDA126671R1	EABAFFFFAAA
				E1.3B-A 1200 Ekip Aware LSI	1SDA126656R1	E1BAFFFFBAA	1SDA126672R1	EABAFFFFBAA
				E1.3B-A 1200 Ekip Aware LSIG	1SDA129044R1	E1BAFFFFCAA	1SDA129052R1	EABAFFFFCAA
E1.3N-A	800	50	50	E1.3N-A 800 Ekip Aware LI	1SDA126657R1	E1NADDFFAAA	1SDA126673R1	EANADDFFAAA
				E1.3N-A 800 Ekip Aware LSI	1SDA126658R1	E1NADDFFBAA	1SDA126674R1	EANADDFFBAA
				E1.3N-A 800 Ekip Aware LSIG	1SDA129045R1	E1NADDFFCAA	1SDA129053R1	EANADDFFCAA
	1200	50	50	E1.3N-A 1200 Ekip Aware LI	1SDA126659R1	E1NAFFFFAAA	1SDA126675R1	EANAFFFFAAA
				E1.3N-A 1200 Ekip Aware LSI	1SDA126660R1	E1NAFFFFBAA	1SDA126676R1	EANAFFFFBAA
				E1.3N-A 1200 Ekip Aware LSIG	1SDA129046R1	E1NAFFFFCAA	1SDA129054R1	EANAFFFFCAA

SACE Emax E1.3S-A • Front terminals (F)

Size	Frame Amps	Int. Rating (kA@508V)	Withstand (kA)	Type	3P		4P	
					Global PN	US / CA PN	Global PN	US / CA PN
E1.3S-A	250	65	50	E1.3S-A 250 Ekip Aware LI	1SDA126661R1	E1SAAAFFAAA	1SDA126677R1	EASAAAFFAAA
				E1.3S-A 250 Ekip Aware LSI	1SDA126662R1	E1SAAAFFBAA	1SDA126678R1	EASAAAFFBAA
				E1.3S-A 250 Ekip Aware LSIG	1SDA129047R1	E1SAAAFFCAA	1SDA129055R1	EASAAAFFCAA
	400	65	50	E1.3S-A 400 Ekip Aware LI	1SDA126663R1	E1SABBF AAA	1SDA126679R1	EASABBF AAA
				E1.3S-A 400 Ekip Aware LSI	1SDA126664R1	E1SABBF BAA	1SDA126680R1	EASABBF BAA
				E1.3S-A 400 Ekip Aware LSIG	1SDA129048R1	E1SABBF CAA	1SDA129056R1	EASABBF CAA
	800	65	50	E1.3S-A 800 Ekip Aware LI	1SDA126665R1	E1SADFF AAA	1SDA126681R1	EASADFF AAA
				E1.3S-A 800 Ekip Aware LSI	1SDA126666R1	E1SADFF BAA	1SDA126682R1	EASADFF BAA
				E1.3S-A 800 Ekip Aware LSIG	1SDA129049R1	E1SADFF CAA	1SDA129057R1	EASADFF CAA
1200	65	50	E1.3S-A 1200 Ekip Aware LI	1SDA126667R1	E1SAFFFF AAA	1SDA126683R1	EASAFFFF AAA	
			E1.3S-A 1200 Ekip Aware LSI	1SDA126668R1	E1SAFFFF BAA	1SDA126684R1	EASAFFFF BAA	
			E1.3S-A 1200 Ekip Aware LSIG	1SDA129050R1	E1SAFFFF CAA	1SDA129058R1	EASAFFFF CAA	

About wall mount is standard; for floor fixing must order: 1SDA076020R1 ZE1FFPF

SACE Emax 3 low voltage power circuit breakers

Automatic circuit-breakers

Fixed version for power distribution



SACE EMAX 3 E2.3B-A/N-A • Orientable rear terminals (HR)

Size	Frame Amps	Int. Rating (kA@508V)	Withstand (kA)	Type	3P		4P	
					Global PN	US / CA PN	Global PN	US / CA PN
E2.3B-A	1600	42	42	E2.3B-A 1600 Ekip Aware LI	1SDA126717R1	E2BAGGHHAAA	1SDA126751R1	EBBAGGHHAAA
				E2.3B-A 1600 Ekip Aware LSI	1SDA126718R1	E2BAGGHHBAA	1SDA126752R1	EBBAGGHHBAA
				E2.3B-A 1600 Ekip Aware LSIG	1SDA129075R1	E2BAGGHHCAA	1SDA129092R1	EBBAGGHHCAA
E2.3N-A	1600	50	50	E2.3N-A 1600 Ekip Aware LI	1SDA126727R1	E2NAGGHHAAA	1SDA126761R1	EBNAGGHHAAA
				E2.3N-A 1600 Ekip Aware LSI	1SDA126728R1	E2NAGGHHBAA	1SDA126762R1	EBNAGGHHBAA
				E2.3N-A 1600 Ekip Aware LSIG	1SDA129080R1	E2NAGGHHCAA	1SDA129097R1	EBNAGGHHCAA
	2000	50	50	E2.3N-A 2000 Ekip Aware LI	1SDA126729R1	E2NAHHHHAAA	1SDA126763R1	EBNAHHHHAAA
				E2.3N-A 2000 Ekip Aware LSI	1SDA126730R1	E2NAHHHHBAA	1SDA126764R1	EBNAHHHHBAA
				E2.3N-A 2000 Ekip Aware LSIG	1SDA129081R1	E2NAHHHHCAA	1SDA129098R1	EBNAHHHHCAA

SACE EMAX 3 E2.3S-A • Orientable rear terminals (HR)

Size	Frame Amps	Int. Rating (kA@508V)	Withstand (kA)	Type	3P		4P	
					Global PN	US / CA PN	Global PN	US / CA PN
E2.3S-A	800	65	65	E2.3S-A 800 Ekip Aware LI	1SDA126731R1	E2SADDHHAAA	1SDA126765R1	EBSADDHHAAA
				E2.3S-A 800 Ekip Aware LSI	1SDA126732R1	E2SADDHHBAA	1SDA126766R1	EBSADDHHBAA
				E2.3S-A 800 Ekip Aware LSIG	1SDA129082R1	E2SADDHHCAA	1SDA129099R1	EBSADDHHCAA
1200	65	65	E2.3S-A 1200 Ekip Aware LI	1SDA126733R1	E2SAFFHHAAA	1SDA126767R1	EBSAFFHHAAA	
			E2.3S-A 1200 Ekip Aware LSI	1SDA126734R1	E2SAFFHHBAA	1SDA126768R1	EBSAFFHHBAA	
			E2.3S-A 1200 Ekip Aware LSIG	1SDA129083R1	E2SAFFHHCAA	1SDA129100R1	EBSAFFHHCAA	
1600	65	65	E2.3S-A 1600 Ekip Aware LI	1SDA126735R1	E2SAGGHHAAA	1SDA126769R1	EBSAGGHHAAA	
			E2.3S-A 1600 Ekip Aware LSI	1SDA126736R1	E2SAGGHHBAA	1SDA126770R1	EBSAGGHHBAA	
			E2.3S-A 1600 Ekip Aware LSIG	1SDA129084R1	E2SAGGHHCAA	1SDA129101R1	EBSAGGHHCAA	
2000	65	65	E2.3S-A 2000 Ekip Aware LI	1SDA126737R1	E2SAHHHHAAA	1SDA126771R1	EBSAHHHHAAA	
			E2.3S-A 2000 Ekip Aware LSI	1SDA126738R1	E2SAHHHHBAA	1SDA126772R1	EBSAHHHHBAA	
			E2.3S-A 2000 Ekip Aware LSIG	1SDA129085R1	E2SAHHHHCAA	1SDA129102R1	EBSAHHHHCAA	

SACE Emax 3 low voltage power circuit breakers

Automatic circuit-breakers

Fixed version for power distribution

SACE EMAX 3 E2.3H-A • Orientable rear terminals (HR)

Size	Frame Amps	Int. Rating (kA@508V)	Withstand (kA)	Type	3P		4P	
					Global PN	US / CA PN	Global PN	US / CA PN
E2.3H-A	800	85	85	E2.3H-A 800 Ekip Aware LI	1SDA126719R1	E2HADDHHAAA	1SDA126753R1	EBHADDHHAAA
				E2.3H-A 800 Ekip Aware LSI	1SDA126720R1	E2HADDHHBAA	1SDA126754R1	EBHADDHHBAA
				E2.3H-A 800 Ekip Aware LSI SIG	1SDA129076R1	E2HADDHHCAA	1SDA129093R1	EBHADDHHCAA
	1200	85	85	E2.3H-A 1200 Ekip Aware LI	1SDA126721R1	E2HAFFHHAAA	1SDA126755R1	EBHAFFHHAAA
				E2.3H-A 1200 Ekip Aware LSI	1SDA126722R1	E2HAFFHHBAA	1SDA126756R1	EBHAFFHHBAA
				E2.3H-A 1200 Ekip Aware LSI SIG	1SDA129077R1	E2HAFFHHCAA	1SDA129094R1	EBHAFFHHCAA
	1600	85	85	E2.3H-A 1600 Ekip Aware LI	1SDA126723R1	E2HAGGHHAAA	1SDA126757R1	EBHAGGHHAAA
				E2.3H-A 1600 Ekip Aware LSI	1SDA126724R1	E2HAGGHHBAA	1SDA126758R1	EBHAGGHHBAA
				E2.3H-A 1600 Ekip Aware LSI SIG	1SDA129078R1	E2HAGGHHCAA	1SDA129095R1	EBHAGGHHCAA
2000	85	85	E2.3H-A 2000 Ekip Aware LI	1SDA126725R1	E2HAHHHHAAA	1SDA126759R1	EBHAHHHHAAA	
			E2.3H-A 2000 Ekip Aware LSI	1SDA126726R1	E2HAHHHHBAA	1SDA126760R1	EBHAHHHHBAA	
			E2.3H-A 2000 Ekip Aware LSI SIG	1SDA129079R1	E2HAHHHHCAA	1SDA129096R1	EBHAHHHHCAA	

SACE EMAX 3 E2.3V-A • Orientable rear terminals (HR)

Size	Frame Amps	Int. Rating (kA@508V)	Withstand (kA)	Type	3P		4P	
					Global PN	US / CA PN	Global PN	US / CA PN
E2.3V-A	250	100	85	E2.3V-A 250 Ekip Aware LI	1SDA126739R1	E2VAAAHHAAA	1SDA126773R1	EBVAAAHHAAA
				E2.3V-A 250 Ekip Aware LSI	1SDA126740R1	E2VAAAHHBAA	1SDA126774R1	EBVAAAHHBAA
				E2.3V-A 250 Ekip Aware LSI SIG	1SDA129086R1	E2VAAAHHCAA	1SDA129103R1	EBVAAAHHCAA
	400	100	85	E2.3V-A 400 Ekip Aware LI	1SDA126741R1	E2VABBBHAAA	1SDA126775R1	EBVABBBHAAA
				E2.3V-A 400 Ekip Aware LSI	1SDA126742R1	E2VABBBHBAA	1SDA126776R1	EBVABBBHBAA
				E2.3V-A 400 Ekip Aware LSI SIG	1SDA129087R1	E2VABBBHCAA	1SDA129104R1	EBVABBBHCAA
	800	100	85	E2.3V-A 800 Ekip Aware LI	1SDA126743R1	E2VADDHHAAA	1SDA126777R1	EBVADDHHAAA
				E2.3V-A 800 Ekip Aware LSI	1SDA126744R1	E2VADDHHBAA	1SDA126778R1	EBVADDHHBAA
				E2.3V-A 800 Ekip Aware LSI SIG	1SDA129088R1	E2VADDHHCAA	1SDA129105R1	EBVADDHHCAA
1200	100	85	E2.3V-A 1200 Ekip Aware LI	1SDA126745R1	E2VAFFHHAAA	1SDA126779R1	EBVAFFHHAAA	
			E2.3V-A 1200 Ekip Aware LSI	1SDA126746R1	E2VAFFHHBAA	1SDA126780R1	EBVAFFHHBAA	
			E2.3V-A 1200 Ekip Aware LSI SIG	1SDA129089R1	E2VAFFHHCAA	1SDA129106R1	EBVAFFHHCAA	
1600	100	85	E2.3V-A 1600 Ekip Aware LI	1SDA126747R1	E2VAGGHHAAA	1SDA126781R1	EBVAGGHHAAA	
			E2.3V-A 1600 Ekip Aware LSI	1SDA126748R1	E2VAGGHHBAA	1SDA126782R1	EBVAGGHHBAA	
			E2.3V-A 1600 Ekip Aware LSI SIG	1SDA129090R1	E2VAGGHHCAA	1SDA129107R1	EBVAGGHHCAA	
2000	100	85	E2.3V-A 2000 Ekip Aware LI	1SDA126749R1	E2VAHHHHAAA	1SDA126783R1	EBVAHHHHAAA	
			E2.3V-A 2000 Ekip Aware LSI	1SDA126750R1	E2VAHHHHBAA	1SDA126784R1	EBVAHHHHBAA	
			E2.3V-A 2000 Ekip Aware LSI SIG	1SDA129091R1	E2VAHHHHCAA	1SDA129108R1	EBVAHHHHCAA	

SACE Emax 3 low voltage power circuit breakers

Automatic circuit-breakers

Fixed version for power distribution



SACE EMAX 3 E4.3S-A/H-A • Orientable rear terminals up to 2500 A (HR)

Size	Frame Amps	Int. Rating (kA@508V)	Withstand (kA)	Type	3P		4P	
					Global PN	US / CA PN	Global PN	US / CA PN
E4.3S-A	2500	65	65	E4.3S-A 2500 Ekip Aware LI	1SDA126861R1	E4SAJJHHAAA	1SDA126889R1	ECSAJJHHAAA
				E4.3S-A 2500 Ekip Aware LSI	1SDA126862R1	E4SAJJHHBAA	1SDA126890R1	ECSAJJHHBAA
				E4.3S-A 2500 Ekip Aware LSIG	1SDA129147R1	E4SAJJHHCAA	1SDA129161R1	ECSAJJHHCAA
	3200 (1)	65	65	E4.3S-A 3200 Ekip Aware LI	1SDA126865R1	E4SALLVVAAA	1SDA126893R1	ECSALLVVAAA
				E4.3S-A 3200 Ekip Aware LSI	1SDA126866R1	E4SALLVVBAA	1SDA126894R1	ECSALLVVBAA
				E4.3S-A 3200 Ekip Aware LSIG	1SDA129149R1	E4SALLVVCAA	1SDA129163R1	ECSALLVVCAA
	3600 (1)	65	65	E4.3S-A 3600 Ekip Aware LI	1SDA126867R1	E4SAMMVVAAA	-	-
				E4.3S-A 3600 Ekip Aware LSI	1SDA126868R1	E4SAMMVVBA	-	-
				E4.3S-A 3600 Ekip Aware LSIG	1SDA129150R1	E4SAMMVVCAA	-	-
E4.3H-A	2500	85	85	E4.3H-A 2500 Ekip Aware LI	1SDA126853R1	E4HAJJHHAAA	1SDA126883R1	ECHAJJHHAAA
				E4.3H-A 2500 Ekip Aware LSI	1SDA126854R1	E4HAJJHHBAA	1SDA126884R1	ECHAJJHHBAA
				E4.3H-A 2500 Ekip Aware LSIG	1SDA129143R1	E4HAJJHHCAA	1SDA129158R1	ECHAJJHHCAA
	3200 ¹	85	85	E4.3H-A 3200 Ekip Aware LI	1SDA126857R1	E4HALLVVAAA	1SDA126887R1	ECHALLVVAAA
				E4.3H-A 3200 Ekip Aware LSI	1SDA126858R1	E4HALLVVBAA	1SDA126888R1	ECHALLVVBAA
				E4.3H-A 3200 Ekip Aware LSIG	1SDA129145R1	E4HALLVVCAA	1SDA129160R1	ECHALLVVCAA

¹ 3200A ratings only with rear vertical terminals

SACE EMAX 3 E4.3V-A • Orientable rear terminals up to 2500 A (HR)

Size	Frame Amps	Int. Rating (kA@508V)	Withstand (kA)	Type	3P		4P	
					Global PN	US / CA PN	Global PN	US / CA PN
E4.3V-A	800	100	85	E4.3V-A 800 Ekip Aware LI	1SDA126869R1	E4VADDHAAA	1SDA126895R1	ECVADDHAAA
				E4.3V-A 800 Ekip Aware LSI	1SDA126870R1	E4VADDHHBAA	1SDA126896R1	ECVADDHHBAA
				E4.3V-A 800 Ekip Aware LSIG	1SDA129151R1	E4VADDHCAA	1SDA129164R1	ECVADDHCAA
	1600	100	85	E4.3V-A 1600 Ekip Aware LI	1SDA126871R1	E4VAGGHHAAA	1SDA126897R1	ECVAGGHHAAA
				E4.3V-A 1600 Ekip Aware LSI	1SDA126872R1	E4VAGGHHBAA	1SDA126898R1	ECVAGGHHBAA
				E4.3V-A 1600 Ekip Aware LSIG	1SDA129152R1	E4VAGGHHCAA	1SDA129165R1	ECVAGGHHCAA
	2000	100	85	E4.3V-A 2000 Ekip Aware LI	1SDA126873R1	E4VAHHHHAAA	1SDA126899R1	ECVAHHHHAAA
				E4.3V-A 2000 Ekip Aware LSI	1SDA126874R1	E4VAHHHHBAA	1SDA126900R1	ECVAHHHHBAA
				E4.3V-A 2000 Ekip Aware LSIG	1SDA129153R1	E4VAHHHHCAA	1SDA129166R1	ECVAHHHHCAA
2500	100	85	E4.3V-A 2500 Ekip Aware LI	1SDA126875R1	E4VAJJHHAAA	1SDA126901R1	ECVAJJHHAAA	
			E4.3V-A 2500 Ekip Aware LSI	1SDA126876R1	E4VAJJHHBAA	1SDA126902R1	ECVAJJHHBAA	
			E4.3V-A 2500 Ekip Aware LSIG	1SDA129154R1	E4VAJJHHCAA	1SDA129167R1	ECVAJJHHCAA	
3200 ¹	100	85	E4.3V-A 3200 Ekip Aware LI	1SDA126879R1	E4VALLVAAA	1SDA126905R1	ECVALLVAAA	
			E4.3V-A 3200 Ekip Aware LSI	1SDA126880R1	E4VALLVBA	1SDA126906R1	ECVALLVBA	
			E4.3V-A 3200 Ekip Aware LSIG	1SDA129156R1	E4VALLVCAA	1SDA129169R1	ECVALLVCAA	

¹ 3200A ratings only with rear vertical terminals

SACE Emax 3 low voltage power circuit breakers

Automatic circuit-breakers

Fixed version for power distribution



SACE EMAX 3 E6.3H-A/V-A • Orientable rear terminals up to 5000A (HR)

Size	Frame Amps	Int. Rating (kA@508V)	Withstand (kA)	Type	3P		4P 50% Neutral		
					Global PN	US / CA PN	Global PN	US / CA PN	
E6.3H-A	4000	85	85	E6.3H-A 4000 Ekip Aware LI	1SDA126955R1	E6HANNHHAAA	1SDA126963R1	EDHANNHHAAA	
				E6.3H-A 4000 Ekip Aware LSI	1SDA126956R1	E6HANNHHBAA	1SDA126964R1	EDHANNHHBAA	
				E6.3H-A 4000 Ekip Aware LSIg	1SDA129194R1	E6HANNHHCAA	1SDA129198R1	EDHANNHHCAA	
	5000	85	85	E6.3H-A 5000 Ekip Aware LI	1SDA126957R1	E6HAPPHHAAA	1SDA126965R1	EDHAPPHHAAA	
				E6.3H-A 5000 Ekip Aware LSI	1SDA126958R1	E6HAPPHHBAA	1SDA126966R1	EDHAPPHHBAA	
				E6.3H-A 5000 Ekip Aware LSIg	1SDA129195R1	E6HAPPHHCAA	1SDA129199R1	EDHAPPHHCAA	
	E6.3V-A	4000	100	100	E6.3V-A 4000 Ekip Aware LI	1SDA126959R1	E6VANNHHAAA	1SDA126967R1	EDVANNHHAAA
					E6.3V-A 4000 Ekip Aware LSI	1SDA126960R1	E6VANNHHBAA	1SDA126968R1	EDVANNHHBAA
					E6.3V-A 4000 Ekip Aware LSIg	1SDA129196R1	E6VANNHHCAA	1SDA129200R1	EDVANNHHCAA
5000		100	100	E6.3V-A 5000 Ekip Aware LI	1SDA126961R1	E6VAPPHHAAA	1SDA126969R1	EDVAPPHHAAA	
				E6.3V-A 5000 Ekip Aware LSI	1SDA126962R1	E6VAPPHHBAA	1SDA126970R1	EDVAPPHHBAA	
				E6.3V-A 5000 Ekip Aware LSIg	1SDA129197R1	E6VAPPHHCAA	1SDA129201R1	EDVAPPHHCAA	

SACE EMAX 3 E6.3H-A/F/V-A/F full size • Orientable rear terminals up to 5000A (HR)

Size	Frame Amps	Int. Rating (kA@508V)	Withstand (kA)	Type	4P 100% Neutral		
					Global PN	US / CA PN	
E6.3H-A/f	4000	85	85	E6.3H-A/f 4000 Ekip Aware LI	1SDA126991R1	EEHANNHHAAA	
				E6.3H-A/f 4000 Ekip Aware LSI	1SDA126992R1	EEHANNHHBAA	
				E6.3H-A/f 4000 Ekip Aware LSIg	1SDA129212R1	EEHANNHHCAA	
	5000	85	85	E6.3H-A/f 5000 Ekip Aware LI	1SDA126993R1	EEHAPPHHAAA	
				E6.3H-A/f 5000 Ekip Aware LSI	1SDA126994R1	EEHAPPHHBAA	
				E6.3H-A/f 5000 Ekip Aware LSIg	1SDA129213R1	EEHAPPHHCAA	
	E6.3V-A/f	4000	100	100	E6.3V-A/f 4000 Ekip Aware LI	1SDA126995R1	EEVANNHHAAA
					E6.3V-A/f 4000 Ekip Aware LSI	1SDA126996R1	EEVANNHHBAA
					E6.3V-A/f 4000 Ekip Aware LSIg	1SDA129214R1	EEVANNHHCAA
5000		100	100	E6.3V-A/f 5000 Ekip Aware LI	1SDA126997R1	EEVAPPHHAAA	
				E6.3V-A/f 5000 Ekip Aware LSI	1SDA126998R1	EEVAPPHHBAA	
				E6.3V-A/f 5000 Ekip Aware LSIg	1SDA129215R1	EEVAPPHHCAA	

SACE Emax 3 low voltage power circuit breakers

Automatic circuit-breakers

Drawout version for power distribution



SACE EMAX 3 E1.2B-A/N-A/S-A • Mobile part of drawout circuit breaker (MP)

Size	Frame Amps	Int. Rating (kA@508V)	Withstand (kA)	Type	3P		4P		
					Global PN	US / CA PN	Global PN	US / CA PN	
E1.3B-A	800	42	42	E1.3B-A 800 Ekip Aware LI	1SDA126685R1	E1BADDMPAAA	1SDA126701R1	EABADDMPAAA	
				E1.3B-A 800 Ekip Aware LSI	1SDA126686R1	E1BADDMPBAA	1SDA126702R1	EABADDMPBAA	
				E1.3B-A 800 Ekip Aware LSIG	1SDA129059R1	E1BADDMPCAA	1SDA129067R1	EABADDMPCAA	
	1200	42	42	E1.3B-A 1200 Ekip Aware LI	1SDA126687R1	E1BAFFMPAAA	1SDA126703R1	EABAFFMPAAA	
				E1.3B-A 1200 Ekip Aware LSI	1SDA126688R1	E1BAFFMPBAA	1SDA126704R1	EABAFFMPBAA	
				E1.3B-A 1200 Ekip Aware LSIG	1SDA129060R1	E1BAFFMPCAA	1SDA129068R1	EABAFFMPCAA	
	E1.3N-A	800	50	50	E1.3N-A 800 Ekip Aware LI	1SDA126689R1	E1NADDMPAAA	1SDA126705R1	EANADDMPAAA
					E1.3N-A 800 Ekip Aware LSI	1SDA126690R1	E1NADDMPBAA	1SDA126706R1	EANADDMPBAA
					E1.3N-A 800 Ekip Aware LSIG	1SDA129061R1	E1NADDMPCAA	1SDA129069R1	EANADDMPCAA
1200		50	50	E1.3N-A 1200 Ekip Aware LI	1SDA126691R1	E1NAFFMPAAA	1SDA126707R1	EANAFFMPAAA	
				E1.3N-A 1200 Ekip Aware LSI	1SDA126692R1	E1NAFFMPBAA	1SDA126708R1	EANAFFMPBAA	
				E1.3N-A 1200 Ekip Aware LSIG	1SDA129062R1	E1NAFFMPCAA	1SDA129070R1	EANAFFMPCAA	
E1.3S-A	250	65	50	E1.3S-A 250 Ekip Aware LI	1SDA126693R1	E1SAAAMPAAA	1SDA126709R1	EASAAAMPAAA	
				E1.3S-A 250 Ekip Aware LSI	1SDA126694R1	E1SAAAMPBAA	1SDA126710R1	EASAAAMPBAA	
				E1.3S-A 250 Ekip Aware LSIG	1SDA129063R1	E1SAAAMPCAA	1SDA129071R1	EASAAAMPCAA	
	400	65	50	E1.3S-A 400 Ekip Aware LI	1SDA126695R1	E1SABMPAAA	1SDA126711R1	EASABMPAAA	
				E1.3S-A 400 Ekip Aware LSI	1SDA126696R1	E1SABMPBAA	1SDA126712R1	EASABMPBAA	
				E1.3S-A 400 Ekip Aware LSIG	1SDA129064R1	E1SABMPCAA	1SDA129072R1	EASABMPCAA	
	800	65	50	E1.3S-A 800 Ekip Aware LI	1SDA126697R1	E1SADDMPAAA	1SDA126713R1	EASADDMPAAA	
				E1.3S-A 800 Ekip Aware LSI	1SDA126698R1	E1SADDMPBAA	1SDA126714R1	EASADDMPBAA	
				E1.3S-A 800 Ekip Aware LSIG	1SDA129065R1	E1SADDMPCAA	1SDA129073R1	EASADDMPCAA	
	1200	65	50	E1.3S-A 1200 Ekip Aware LI	1SDA126699R1	E1SAFFMPAAA	1SDA126715R1	EASAFFMPAAA	
				E1.3S-A 1200 Ekip Aware LSI	1SDA126700R1	E1SAFFMPBAA	1SDA126716R1	EASAFFMPBAA	
				E1.3S-A 1200 Ekip Aware LSIG	1SDA129066R1	E1SAFFMPCAA	1SDA129074R1	EASAFFMPCAA	

SACE Emax 3 low voltage power circuit breakers

Automatic circuit-breakers

Drawout version for power distribution

SACE EMAX 3 E2.3B-A/N-A/S-A/H-A- Mobile part of drawout circuit br. (MP)

Size	Frame Amps	Int. Rating (kA@508V)	Withstand (kA)	Type	3P		4P	
					Global PN	US / CA PN	Global PN	US / CA PN
E2.3B-A	1600	42	42	E2.3B-A 1600 Ekip Aware LI	1SDA126785R1	E2BAGGMPAAA	1SDA126819R1	EBBAGGMPAAA
				E2.3B-A 1600 Ekip Aware LSI	1SDA126786R1	E2BAGGMPBAA	1SDA126820R1	EBBAGGMPBAA
				E2.3B-A 1600 Ekip Aware LSIG	1SDA129109R1	E2BAGGMPCAA	1SDA129126R1	EBBAGGMPCAA
E2.3N-A	1600	50	50	E2.3N-A 1600 Ekip Aware LI	1SDA126795R1	E2NAGGMPAAA	1SDA126829R1	EBNAGGMPAAA
				E2.3N-A 1600 Ekip Aware LSI	1SDA126796R1	E2NAGGMPBAA	1SDA126830R1	EBNAGGMPBAA
				E2.3N-A 1600 Ekip Aware LSIG	1SDA129114R1	E2NAGGMPCAA	1SDA129131R1	EBNAGGMPCAA
	2000	50	50	E2.3N-A 2000 Ekip Aware LI	1SDA126797R1	E2NAHHMPAAA	1SDA126831R1	EBNAHHMPAAA
				E2.3N-A 2000 Ekip Aware LSI	1SDA126798R1	E2NAHHMPBAA	1SDA126832R1	EBNAHHMPBAA
				E2.3N-A 2000 Ekip Aware LSIG	1SDA129115R1	E2NAHHMPCAA	1SDA129132R1	EBNAHHMPCAA
E2.3S-A	800	65	65	E2.3S-A 800 Ekip Aware LI	1SDA126799R1	E2SADDMPAAA	1SDA126833R1	EBSADDMPAAA
				E2.3S-A 800 Ekip Aware LSI	1SDA126800R1	E2SADDMPBAA	1SDA126834R1	EBSADDMPBAA
				E2.3S-A 800 Ekip Aware LSIG	1SDA129116R1	E2SADDMPCAA	1SDA129133R1	EBSADDMPCAA
	1200	65	65	E2.3S-A 1200 Ekip Aware LI	1SDA126801R1	E2SAFFMPAAA	1SDA126835R1	EBSAFFMPAAA
				E2.3S-A 1200 Ekip Aware LSI	1SDA126802R1	E2SAFFMPBAA	1SDA126836R1	EBSAFFMPBAA
				E2.3S-A 1200 Ekip Aware LSIG	1SDA129117R1	E2SAFFMPCAA	1SDA129134R1	EBSAFFMPCAA
	1600	65	65	E2.3S-A 1600 Ekip Aware LI	1SDA126803R1	E2SAGGMPAAA	1SDA126837R1	EBSAGGMPAAA
				E2.3S-A 1600 Ekip Aware LSI	1SDA126804R1	E2SAGGMPBAA	1SDA126838R1	EBSAGGMPBAA
				E2.3S-A 1600 Ekip Aware LSIG	1SDA129118R1	E2SAGGMPCAA	1SDA129135R1	EBSAGGMPCAA
	2000	65	65	E2.3S-A 2000 Ekip Aware LI	1SDA126805R1	E2SAHHMPAAA	1SDA126839R1	EBSAHHMPAAA
				E2.3S-A 2000 Ekip Aware LSI	1SDA126806R1	E2SAHHMPBAA	1SDA126840R1	EBSAHHMPBAA
				E2.3S-A 2000 Ekip Aware LSIG	1SDA129119R1	E2SAHHMPCAA	1SDA129136R1	EBSAHHMPCAA
E2.3H-A	800	85	85	E2.3H-A 800 Ekip Aware LI	1SDA126787R1	E2HADDMPAAA	1SDA126821R1	EBHADDMPAAA
				E2.3H-A 800 Ekip Aware LSI	1SDA126788R1	E2HADDMPBAA	1SDA126822R1	EBHADDMPBAA
				E2.3H-A 800 Ekip Aware LSIG	1SDA129110R1	E2HADDMPCAA	1SDA129127R1	EBHADDMPCAA
	1200	85	85	E2.3H-A 1200 Ekip Aware LI	1SDA126789R1	E2HAFFMPAAA	1SDA126823R1	EBHAFFMPAAA
				E2.3H-A 1200 Ekip Aware LSI	1SDA126790R1	E2HAFFMPBAA	1SDA126824R1	EBHAFFMPBAA
				E2.3H-A 1200 Ekip Aware LSIG	1SDA129111R1	E2HAFFMPCAA	1SDA129128R1	EBHAFFMPCAA
	1600	85	85	E2.3H-A 1600 Ekip Aware LI	1SDA126791R1	E2HAGGMPAAA	1SDA126825R1	EBHAGGMPAAA
				E2.3H-A 1600 Ekip Aware LSI	1SDA126792R1	E2HAGGMPBAA	1SDA126826R1	EBHAGGMPBAA
				E2.3H-A 1600 Ekip Aware LSIG	1SDA129112R1	E2HAGGMPCAA	1SDA129129R1	EBHAGGMPCAA
	2000	85	85	E2.3H-A 2000 Ekip Aware LI	1SDA126793R1	E2HAHHMPAAA	1SDA126827R1	EBHAHHMPAAA
				E2.3H-A 2000 Ekip Aware LSI	1SDA126794R1	E2HAHHMPBAA	1SDA126828R1	EBHAHHMPBAA
				E2.3H-A 2000 Ekip Aware LSIG	1SDA129113R1	E2HAHHMPCAA	1SDA129130R1	EBHAHHMPCAA

SACE Emax 3 low voltage power circuit breakers

Automatic circuit-breakers

Drawout version for power distribution



SACE EMAX 3 E2.3V-A • Mobile part of drawout circuit breaker (MP)

Size	Frame Amps	Int. Rating (kA@508V)	Withstand (kA)	Type	3P		4P	
					Global PN	US / CA PN	Global PN	US / CA PN
E2.3V-A	250	100	85	E2.3V-A 250 Ekip Aware LI	1SDA126807R1	E2VAAAMPAAA	1SDA126841R1	EBVAAAMPAAA
				E2.3V-A 250 Ekip Aware LSI	1SDA126808R1	E2VAAAMPBAA	1SDA126842R1	EBVAAAMPBAA
				E2.3V-A 250 Ekip Aware LSIG	1SDA129120R1	E2VAAAMPCAA	1SDA129137R1	EBVAAAMPCAA
400	100	85	E2.3V-A 400 Ekip Aware LI	1SDA126809R1	E2VABBMPAAA	1SDA126843R1	EBVABBMPAAA	
			E2.3V-A 400 Ekip Aware LSI	1SDA126810R1	E2VABBMPBAA	1SDA126844R1	EBVABBMPBAA	
			E2.3V-A 400 Ekip Aware LSIG	1SDA129121R1	E2VABBMPCAA	1SDA129138R1	EBVABBMPCAA	
800	100	85	E2.3V-A 800 Ekip Aware LI	1SDA126811R1	E2VADMPAAA	1SDA126845R1	EBVADMPAAA	
			E2.3V-A 800 Ekip Aware LSI	1SDA126812R1	E2VADMPBAA	1SDA126846R1	EBVADMPBAA	
			E2.3V-A 800 Ekip Aware LSIG	1SDA129122R1	E2VADMPCAA	1SDA129139R1	EBVADMPCAA	
1200	100	85	E2.3V-A 1200 Ekip Aware LI	1SDA126813R1	E2VAFFMPAAA	1SDA126847R1	EBVAFFMPAAA	
			E2.3V-A 1200 Ekip Aware LSI	1SDA126814R1	E2VAFFMPBAA	1SDA126848R1	EBVAFFMPBAA	
			E2.3V-A 1200 Ekip Aware LSIG	1SDA129123R1	E2VAFFMPCAA	1SDA129140R1	EBVAFFMPCAA	
1600	100	85	E2.3V-A 1600 Ekip Aware LI	1SDA126815R1	E2VAGGMPAAA	1SDA126849R1	EBVAGGMPAAA	
			E2.3V-A 1600 Ekip Aware LSI	1SDA126816R1	E2VAGGMPBAA	1SDA126850R1	EBVAGGMPBAA	
			E2.3V-A 1600 Ekip Aware LSIG	1SDA129124R1	E2VAGGMPCAA	1SDA129141R1	EBVAGGMPCAA	
2000	100	85	E2.3V-A 2000 Ekip Aware LI	1SDA126817R1	E2VAHHMPAAA	1SDA126851R1	EBVAHHMPAAA	
			E2.3V-A 2000 Ekip Aware LSI	1SDA126818R1	E2VAHHMPBAA	1SDA126852R1	EBVAHHMPBAA	
			E2.3V-A 2000 Ekip Aware LSIG	1SDA129125R1	E2VAHHMPCAA	1SDA129142R1	EBVAHHMPCAA	

SACE Emax 3 low voltage power circuit breakers

Automatic circuit-breakers

Drawout version for power distribution



SACE EMAX 3 E4.3S-A/H-A/V-A • Mobile part of drawout circuit breaker (MP)

Size	Frame Amps	Int. Rating (kA@508V)	Withstand (kA)	Type	3P		4P		
					Global PN	US / CA PN	Global PN	US / CA PN	
E4.3S-A	2500	65	65	E4.3S-A 2500 Ekip Aware LI	1SDA126913R1	E4SAJJMPAAA	1SDA126937R1	ECSAJJMPAAA	
				E4.3S-A 2500 Ekip Aware LSI	1SDA126914R1	E4SAJJMPBAA	1SDA126938R1	ECSAJJMPBAA	
				E4.3S-A 2500 Ekip Aware LSIG	1SDA129173R1	E4SAJJPCCAA	1SDA129185R1	ECSAJJPCCAA	
	3200	65	65	E4.3S-A 3200 Ekip Aware LI	1SDA126917R1	E4SALLMPAAA	1SDA126941R1	ECSALLMPAAA	
				E4.3S-A 3200 Ekip Aware LSI	1SDA126918R1	E4SALLMPBAA	1SDA126942R1	ECSALLMPBAA	
				E4.3S-A 3200 Ekip Aware LSIG	1SDA129175R1	E4SALLMPCAA	1SDA129187R1	ECSALLMPCAA	
	E4.3H-A	2500	85	85	E4.3H-A 2500 Ekip Aware LI	1SDA126907R1	E4HAJJMPAAA	1SDA126931R1	ECHAJJMPAAA
					E4.3H-A 2500 Ekip Aware LSI	1SDA126908R1	E4HAJJMPBAA	1SDA126932R1	ECHAJJMPBAA
					E4.3H-A 2500 Ekip Aware LSIG	1SDA129170R1	E4HAJJPCCAA	1SDA129182R1	ECHAJJPCCAA
3200		85	85	E4.3H-A 3200 Ekip Aware LI	1SDA126911R1	E4HALLMPAAA	1SDA126935R1	ECHALLMPAAA	
				E4.3H-A 3200 Ekip Aware LSI	1SDA126912R1	E4HALLMPBAA	1SDA126936R1	ECHALLMPBAA	
				E4.3H-A 3200 Ekip Aware LSIG	1SDA129172R1	E4HALLMPCAA	1SDA129184R1	ECHALLMPCAA	
E4.3V-A		800	100	85	E4.3V-A 800 Ekip Aware LI	1SDA126919R1	E4VADDMPAAA	1SDA126943R1	ECVADDMPAAA
					E4.3V-A 800 Ekip Aware LSI	1SDA126920R1	E4VADDMPBAA	1SDA126944R1	ECVADDMPBAA
					E4.3V-A 800 Ekip Aware LSIG	1SDA129176R1	E4VADDMPCAA	1SDA129188R1	ECVADDMPCAA
	1600	100	85	E4.3V-A 1600 Ekip Aware LI	1SDA126921R1	E4VAGGMPAAA	1SDA126945R1	ECVAGGMPAAA	
				E4.3V-A 1600 Ekip Aware LSI	1SDA126922R1	E4VAGGMPBAA	1SDA126946R1	ECVAGGMPBAA	
				E4.3V-A 1600 Ekip Aware LSIG	1SDA129177R1	E4VAGGMPCAA	1SDA129189R1	ECVAGGMPCAA	
	2000	100	85	E4.3V-A 2000 Ekip Aware LI	1SDA126923R1	E4VAHHMPAAA	1SDA126947R1	ECVAHHMPAAA	
				E4.3V-A 2000 Ekip Aware LSI	1SDA126924R1	E4VAHHMPBAA	1SDA126948R1	ECVAHHMPBAA	
				E4.3V-A 2000 Ekip Aware LSIG	1SDA129178R1	E4VAHHMPCAA	1SDA129190R1	ECVAHHMPCAA	
	2500	100	85	E4.3V-A 2500 Ekip Aware LI	1SDA126925R1	E4VAJJMPAAA	1SDA126949R1	ECVAJJMPAAA	
				E4.3V-A 2500 Ekip Aware LSI	1SDA126926R1	E4VAJJMPBAA	1SDA126950R1	ECVAJJMPBAA	
				E4.3V-A 2500 Ekip Aware LSIG	1SDA129179R1	E4VAJJPCCAA	1SDA129191R1	ECVAJJPCCAA	
	3200	100	85	E4.3V-A 3200 Ekip Aware LI	1SDA126929R1	E4VALLMPAAA	1SDA126953R1	ECVALLMPAAA	
				E4.3V-A 3200 Ekip Aware LSI	1SDA126930R1	E4VALLMPBAA	1SDA126954R1	ECVALLMPBAA	
				E4.3V-A 3200 Ekip Aware LSIG	1SDA129181R1	E4VALLMPCAA	1SDA129193R1	ECVALLMPCAA	

SACE Emax 3 low voltage power circuit breakers

Automatic circuit-breakers

Drawout version for power distribution



SACE EMAX 3 E6.3H-A/V-A • Mobile part of drawout circuit breaker (MP)

Size	Frame Amps	Int. Rating (kA@508V)	Withstand (kA)	Type	3P		4P 50% Neutral	
					Global PN	US / CA PN	Global PN	US / CA PN
E6.3H-A	4000	85	85	E6.3H-A 4000 Ekip Aware LI	1SDA126971R1	E6HANNMPAAA	1SDA126983R1	EDHANNMPAAA
				E6.3H-A 4000 Ekip Aware LSI	1SDA126972R1	E6HANNMPBAA	1SDA126984R1	EDHANNMPBAA
				E6.3H-A 4000 Ekip Aware LSIG	1SDA129202R1	E6HANNMPCAA	1SDA129208R1	EDHANNMPCAA
	5000	85	85	E6.3H-A 5000 Ekip Aware LI	1SDA126973R1	E6HAPPMPAAA	1SDA126985R1	EDHAPPMPAAA
				E6.3H-A 5000 Ekip Aware LSI	1SDA126974R1	E6HAPPMPBAA	1SDA126986R1	EDHAPPMPBAA
				E6.3H-A 5000 Ekip Aware LSIG	1SDA129203R1	E6HAPPMPCAA	1SDA129209R1	EDHAPPMPCAA
	6000 ¹	85	85	E6.3H-A 6000 Ekip Aware LI	1SDA126975R1	E6HAQQMPAAA	-	-
				E6.3H-A 6000 Ekip Aware LSI	1SDA126976R1	E6HAQQMPBAA	-	-
				E6.3H-A 6000 Ekip Aware LSIG	1SDA129204R1	E6HAQQMPCAA	-	-
E6.3V-A	4000	100	100	E6.3V-A 4000 Ekip Aware LI	1SDA126977R1	E6VANNMPAAA	1SDA126987R1	EDVANNMPAAA
				E6.3V-A 4000 Ekip Aware LSI	1SDA126978R1	E6VANNMPBAA	1SDA126988R1	EDVANNMPBAA
				E6.3V-A 4000 Ekip Aware LSIG	1SDA129205R1	E6VANNMPCAA	1SDA129210R1	EDVANNMPCAA
	5000	100	100	E6.3V-A 5000 Ekip Aware LI	1SDA126979R1	E6VAPPMPAAA	1SDA126989R1	EDVAPPMPAAA
				E6.3V-A 5000 Ekip Aware LSI	1SDA126980R1	E6VAPPMPBAA	1SDA126990R1	EDVAPPMPBAA
				E6.3V-A 5000 Ekip Aware LSIG	1SDA129206R1	E6VAPPMPCAA	1SDA129211R1	EDVAPPMPCAA
	6000	100	100	E6.3V-A 6000 Ekip Aware LI	1SDA126981R1	E6VAQQMPAAA	-	-
				E6.3V-A 6000 Ekip Aware LSI	1SDA126982R1	E6VAQQMPBAA	-	-
				E6.3V-A 6000 Ekip Aware LSIG	1SDA129207R1	E6VAQQMPCAA	-	-

¹ 6000 A ratings available only with read vertical terminals

SACE EMAX 3 E6.3H-A/F/V-A/F • Mobile part of drawout circuit breaker (MP)

Size	Frame Amps	Int. Rating (kA@508V)	Withstand (kA)	Type	4P 100% Neutral	
					Global PN	US / CA PN
E6.3H-A/f	4000	85	85	E6.3H-A/f 4000 Ekip Aware LI	1SDA126999R1	EEHANNMPAAA
				E6.3H-A/f 4000 Ekip Aware LSI	1SDA127000R1	EEHANNMPBAA
				E6.3H-A/f 4000 Ekip Aware LSIG	1SDA129216R1	EEHANNMPCAA
	5000	85	85	E6.3H-A/f 5000 Ekip Aware LI	1SDA127001R1	EEHAPPMPAAA
				E6.3H-A/f 5000 Ekip Aware LSI	1SDA127002R1	EEHAPPMPBAA
				E6.3H-A/f 5000 Ekip Aware LSIG	1SDA129217R1	EEHAPPMPCAA
	6000 ¹	85	85	E6.3H-A/f 6000 Ekip Aware LI	-	-
				E6.3H-A/f 6000 Ekip Aware LSI	-	-
				E6.3H-A/f 6000 Ekip Aware LSIG	-	-
E6.3V-A/f	4000	100	100	E6.3V-A/f 4000 Ekip Aware LI	1SDA127003R1	EEVANNMPAAA
				E6.3V-A/f 4000 Ekip Aware LSI	1SDA127004R1	EEVANNMPBAA
				E6.3V-A/f 4000 Ekip Aware LSIG	1SDA129218R1	EEVANNMPCAA
	5000	100	100	E6.3V-A/f 5000 Ekip Aware LI	1SDA127005R1	EEVAPPMPAAA
				E6.3V-A/f 5000 Ekip Aware LSI	1SDA127006R1	EEVAPPMPBAA
				E6.3V-A/f 5000 Ekip Aware LSIG	1SDA129219R1	EEVAPPMPCAA
	6000	100	100	E6.3V-A/f 6000 Ekip Aware LI	-	-
				E6.3V-A/f 6000 Ekip Aware LSI	-	-
				E6.3V-A/f 6000 Ekip Aware LSIG	-	-

¹ 6000 A ratings available only with read vertical term

SACE Emax 3 low voltage power circuit breakers

Switch-disconnectors

Fixed version

SACE EMAX 3 E1.3 B-A/MS, N-A/MS • Front terminals (F)

Size	Frame Amps	Withstand (kA)	Type	3P		4P	
				Global PN	US / CA PN	Global PN	US / CA PN
E1.3B-A/MS	800	42	E1.3B-A/MS 800	1SDA127537R1	E1BAD0FFXXX	1SDA127541R1	EABAD0FFXXX
	1200	42	E1.3B-A/MS 1200	1SDA127538R1	E1BAF0FFXXX	1SDA127542R1	EABAF0FFXXX
E1.3N-A/MS	800	50	E1.3N-A/MS 800	1SDA127539R1	E1NAD0FFXXX	1SDA127543R1	EANAD0FFXXX
	1200	50	E1.3N-A/MS 1200	1SDA127540R1	E1NAF0FFXXX	1SDA127544R1	EANAF0FFXXX

Note: Wall mount is standard; for floor fixing must order: 1SDA076020R1 ZE1FFPF

SACE EMAX 3 E2.3 N-A/MS, S-A/MS, V-A/MS • Orientable rear terminals (HR)

Size	Frame Amps	Withstand (kA)	Type	3P		4P	
				Global PN	US / CA PN	Global PN	US / CA PN
E2.3N-A/MS	1600	50	E2.3N-A/MS 1600	1SDA127559R1	E2NAG0HHXXX	1SDA127567R1	EBNAG0HHXXX
	2000	50	E2.3N-A/MS 2000	1SDA127560R1	E2NAH0HHXXX	1SDA127568R1	EBNAH0HHXXX
E2.3S-A/MS	800	65	E2.3S-A/MS 800	1SDA127553R1	E2SAD0HHXXX	1SDA127561R1	EBSAD0HHXXX
	1600	65	E2.3S-A/MS 1600	1SDA127554R1	E2SAG0HHXXX	1SDA127562R1	EBSAG0HHXXX
	2000	65	E2.3S-A/MS 2000	1SDA127555R1	E2SAH0HHXXX	1SDA127563R1	EBSAH0HHXXX
E2.3V-A/MS	800	85	E2.3V-A/MS 800	1SDA127556R1	E2VAD0HHXXX	1SDA127564R1	EBVAD0HHXXX
	1600	85	E2.3V-A/MS 1600	1SDA127557R1	E2VAG0HHXXX	1SDA127565R1	EBVAG0HHXXX
	2000	85	E2.3V-A/MS 2000	1SDA127558R1	E2VAH0HHXXX	1SDA127566R1	EBVAH0HHXXX

SACE EMAX 3 E4.3 S-A/MS, H-A/MS, V-A/MS • Orientable rear terminals up to 2500A (HR)

Size	Frame Amps	Withstand (kA)	Type	3P		4P	
				Global PN	US / CA PN	Global PN	US / CA PN
E4.3S-A/MS	2500	65	E4.3S-A/MS 2500	1SDA127585R1	E4SAA0HHXXX	1SDA127604R1	ECSAA0HHXXX
	3200 ¹	65	E4.3S-A/MS 3200	1SDA127587R1	E4SAA0VVXXX	1SDA127606R1	ECSAL0VVXXX
	3600 ¹	65	E4.3S-A/MS 3600	1SDA127588R1	E4SAM0VVXXX	-	-
	1600	65	E2.3S-A/MS 1600	1SDA127554R1	E2SAG0HHXXX	1SDA127562R1	EBSAG0HHXXX
E4.3H-A/MS	2500	85	E4.3H-A/MS 2500	1SDA127674R1	E4HAJ0HHXXX	1SDA127680R1	ECHAJ0HHXXX
	3200 ¹	85	E4.3H-A/MS 3200	1SDA127676R1	E4HAL0VVXXX	1SDA127682R1	ECHAL0VVXXX
	3600 ¹	85	E4.3H-A/MS 3600	1SDA127603R1	E4HAM0VVXXX	-	-
E4.3V-A/MS	800	100	E4.3V-A/MS 800	1SDA127671R1	E4VAD0HHXXX	1SDA127677R1	ECVAD0HHXXX
	1600	100	E4.3V-A/MS 1600	1SDA127672R1	E4VAG0HHXXX	1SDA127678R1	ECVAG0HHXXX
	2000	100	E4.3V-A/MS 2000	1SDA127673R1	E4VAH0HHXXX	1SDA127679R1	ECVAH0HHXXX
	2500	100	E4.3V-A/MS 2500	1SDA127592R1	E4VAJ0HHXXX	1SDA127610R1	ECVAJ0HHXXX
	3200 ¹	100	E4.3V-A/MS 3200	1SDA127594R1	E4VAL0VVXXX	1SDA127612R1	ECVAL0VVXXX

¹ 3200 ratings only with rear vertical terminals

SACE Emax 3 low voltage power circuit breakers

Switch-disconnectors

Fixed version

SACE EMAX 3 E6.3 L-A/MS • Orientable rear terminals up to 5000A (HR)

Size	Frame Amps	Withstand (kA)	Type	3P		4P 50% Neutral	
				Global PN	US / CA PN	Global PN	US / CA PN
E6.3L-A/MS	4000	100	E6.3L-A/MS 4000	1SDA127644R1	E6LAN0HHXXX	1SDA127650R1	EDLAN0HHXXX
	5000	100	E6.3L-A/MS 5000	1SDA127645R1	E6LAP0HHXXX	1SDA127651R1	EDLAP0HHXXX

SACE EMAX 3 E6.3 L-A/F/MS • Orientable rear terminals up to 5000A (HR)

Size	Frame Amps	Withstand (kA)	Type	4P 100% Neutral	
				Global PN	US / CA PN
E6.3L-A/f/MS	4000	100	E6.3L-A/f/MS 4000	1SDA127662R1	EELAN0HHXXX
	5000	100	E6.3L-A/f/MS 5000	1SDA127663R1	EELAP0HHXXX

SACE Emax 3 low voltage power circuit breakers

Switch-disconnectors

Drawout version

SACE EMAX 3 E1.3 B-A/MS, N-A/MS • Mobile part of switch disconnecter (MP)

Size	Frame Amps	Withstand (kA)	Type	3P		4P	
				Global PN	US / CA PN	Global PN	US / CA PN
E1.3B-A/MS	800	42	E1.3B-A/MS 800	1SDA127545R1	E1BAD0MPXXX	1SDA127549R1	EABAD0MPXXX
	1200	42	E1.3B-A/MS 1200	1SDA127546R1	E1BAF0MPXXX	1SDA127550R1	EABAF0MPXXX
E1.3N-A/MS	800	50	E1.3N-A/MS 800	1SDA127547R1	E1NAD0MPXXX	1SDA127551R1	EANAD0MPXXX
	1200	50	E1.3N-A/MS 1200	1SDA127548R1	E1NAF0MPXXX	1SDA127552R1	EANAF0MPXXX

SACE EMAX 3 E2.3 N-A/MS, S-A/MS, V-A/MS • Mobile part of switch disconnecter (MP)

Size	Frame Amps	Withstand (kA)	Type	3P		4P	
				Global PN	US / CA PN	Global PN	US / CA PN
E2.3N-A/MS	1600	50	E2.3N-A/MS 1600	1SDA127575R1	E2NAG0MPXXX	1SDA127583R1	EBNAG0MPXXX
	2000	50	E2.3N-A/MS 2000	1SDA127576R1	E2NAH0MPXXX	1SDA127584R1	EBNAH0MPXXX
E2.3S-A/MS	800	65	E2.3S-A/MS 800	1SDA127569R1	E2SAD0MPXXX	1SDA127577R1	EBSAD0MPXXX
	1600	65	E2.3S-A/MS 1600	1SDA127570R1	E2SAG0MPXXX	1SDA127578R1	EBSAG0MPXXX
	2000	65	E2.3S-A/MS 2000	1SDA127571R1	E2SAH0MPXXX	1SDA127579R1	EBSAH0MPXXX
E2.3V-A/MS	800	85	E2.3V-A/MS 800	1SDA127572R1	E2VAD0MPXXX	1SDA127580R1	EBVAD0MPXXX
	1600	85	E2.3V-A/MS 1600	1SDA127573R1	E2VAG0MPXXX	1SDA127581R1	EBVAG0MPXXX
	2000	85	E2.3V-A/MS 2000	1SDA127574R1	E2VAH0MPXXX	1SDA127582R1	EBVAH0MPXXX

SACE EMAX 3 E4.3 S-A/MS, H-A/MS, V-A/MS • Mobile part of switch disconnecter (MP)

Size	Frame Amps	Withstand (kA)	Type	3P		4P	
				Global PN	US / CA PN	Global PN	US / CA PN
E4.3S-A/MS	2500	65	E4.3S-A/MS 2500	1SDA127620R1	E4SAJ0MPXXX	1SDA127632R1	ECSAJ0MPXXX
	3200	65	E4.3S-A/MS 3200	1SDA127622R1	E4SAL0MPXXX	1SDA127634R1	ECSAL0MPXXX
E4.3H-A/MS	2500	85	E4.3H-A/MS 2500	1SDA127686R1	E4HAJ0MPXXX	1SDA127692R1	ECHAJ0MPXXX
	3200	85	E4.3H-A/MS 3200	1SDA127688R1	E4HAL0MPXXX	1SDA127694R1	ECHAL0MPXXX
E4.3V-A/MS	800	100	E4.3V-A/MS 800	1SDA127683R1	E4VAD0MPXXX	1SDA127689R1	ECVAD0MPXXX
	1600	100	E4.3V-A/MS 1600	1SDA127684R1	E4VAG0MPXXX	1SDA127690R1	ECVAG0MPXXX
	2000	100	E4.3V-A/MS 2000	1SDA127685R1	E4VAH0MPXXX	1SDA127691R1	ECVAH0MPXXX
	2500	100	E4.3V-A/MS 2500	1SDA127626R1	E4VAJ0MPXXX	1SDA127638R1	ECVAJ0MPXXX
	3200	100	E4.3V-A/MS 3200	1SDA127628R1	E4VAL0MPXXX	1SDA127640R1	ECVAL0MPXXX

SACE Emax 3 low voltage power circuit breakers

Switch-disconnectors

Drawout version

SACE EMAX 3 E6.3 L-A/MS • Mobile part of switch disconnecter (MP)

Size	Frame Amps	Withstand (kA)	Type	3P		4P 50% Neutral	
				Global PN	US / CA PN	Global PN	US / CA PN
E6.3L-A/MS	4000	100	E6.3L-A/MS 4000	1SDA127656R1	E6LAN0MPXXX	1SDA127659R1	EDLAN0MPXXX
	5000	100	E6.3L-A/MS 5000	1SDA127657R1	E6LAP0MPXXX	1SDA127660R1	EDLAP0MPXXX
	6000 ¹	100	E6.3L-A/MS 6000	1SDA127658R1	E6LAQ0MPXXX	-	-

¹ 6000A ratings only with rear vertical terminals.

SACE EMAX 3 E6.3 L-A/MS • Mobile part of switch disconnecter (MP)

Size	Frame Amps	Withstand (kA)	Type	4P 100% Neutral	
				Global PN	US / CA PN
E6.3L-A/f/MS	4000	100	E6.3L-A/f/MS 4000	1SDA127668R1	EELAN0MPXXX
	5000	100	E6.3L-A/f/MS 5000	1SDA127669R1	EELAP0MPXXX

SACE Emax 3 low voltage power circuit breakers

Circuit breakers

Multi-Standard: IEC 60947-2/UL1066/CSA C22.2 No. 268/GB/T 14048.2

Size	Performance	Description	3P		
			Global PN	US / CA PN	
E2.3	B	DOUBLE CERTIFICAT: UL/IEC E2.3B EXT	1SDA127774R1	F32B-CERTDOUBLE	Factory installed only
E2.3	N	DOUBLE CERTIFICAT: UL/IEC E2.3N EXT	1SDA127775R1	F32N-CERTDOUBLE	Factory installed only
E2.3	S	DOUBLE CERTIFICAT: UL/IEC E2.3S EXT	1SDA127776R1	F32S-CERTDOUBLE	Factory installed only
E2.3	H	DOUBLE CERTIFICAT: UL/IEC E2.3H EXT	1SDA127777R1	F32H-CERTDOUBLE	Factory installed only
E2.3	V	DOUBLE CERTIFICAT: UL/IEC E2.3V EXT	1SDA127778R1	F32V-CERTDOUBLE	Factory installed only
E4.3	S	DOUBLE CERTIFICAT: UL/IEC E4.3S EXT	1SDA127779R1	F34S-CERTDOUBLE	Factory installed only
E4.3	H	DOUBLE CERTIFICAT: UL/IEC E4.3H EXT	1SDA127780R1	F34H-CERTDOUBLE	Factory installed only
E4.3	V	DOUBLE CERTIFICAT: UL/IEC E4.3V EXT	1SDA127781R1	F34V-CERTDOUBLE	Factory installed only
E6.3	V	DOUBLE CERTIFICAT: UL/IEC E6.3V EXT	1SDA127782R1	F36V-CERTDOUBLE	Factory installed only
			Global PN	US / CA PN	
E2.3	B	Triple certific: UL/IEC/CCC E2.3B-A EXT	1SDA127765R1	F32B-CERTTRIPLE	Factory installed only
E2.3	N	Triple certific: UL/IEC/CCC E2.3N-A EXT	1SDA127766R1	F32N-CERTTRIPLE	Factory installed only
E2.3	S	Triple certific: UL/IEC/CCC E2.3S-A EXT	1SDA127767R1	F32S-CERTTRIPLE	Factory installed only
E2.3	H	Triple certific: UL/IEC/CCC E2.3H-A EXT	1SDA127768R1	F32H-CERTTRIPLE	Factory installed only
E2.3	V	Triple certific: UL/IEC/CCC E2.3V-A EXT	1SDA127769R1	F32V-CERTTRIPLE	Factory installed only
E4.3	S	Triple certific: UL/IEC/CCC E4.3S-A EXT	1SDA127770R1	F34S-CERTTRIPLE	Factory installed only
E4.3	H	Triple certific: UL/IEC/CCC E4.3H-A EXT	1SDA127771R1	F34H-CERTTRIPLE	Factory installed only
E4.3	V	Triple certific: UL/IEC/CCC E4.3V-A EXT	1SDA127772R1	F34V-CERTTRIPLE	Factory installed only
E6.3	V	Triple certific: UL/IEC/CCC E6.3V-A EXT	1SDA127773R1	F36V-CERTTRIPLE	Factory installed only

The multiple-standard Emax 3 can be ordered in the same way you accessories are ordered:

1. Select the right UL circuit breaker you need;
2. Like an accessory configuration, upgrade the circuit breaker with multi-standard performance by adding the code shown above.

SACE Emax 3 low voltage power circuit breakers Cradles

Size	Performance	Amperage range	Terminal type	Type	3P		4P	
					Global PN	US / CA PN	Global PN	US / CA PN
E1.3	B-A, N-A, S-A	250 - 1200	HR - HR	E1.3-A W FP Iu=1200 HR HR UL	1SDA126241R1	E1A12HHXXXX	1SDA126242R1	EAA12HHXXXX
E2.3	B-A, N-A, S-A, H-A, V-A	250 - 2000	HR - HR	E2.3-A W FP Iu=2000 HR HR UL	1SDA126243R1	E2A20HHXXXX	1SDA126244R1	EBA20HHXXXX
E4.3	S-A, H-A, V-A, L-A	800 - 2500	HR - HR	E4.3-A W FP Iu=2500 HR HR UL	1SDA126245R1	E4A25HHXXXX	1SDA126246R1	ECA25HHXXXX
	S-A, H-A, V-A, L-A	3200	VR-VR	E4.3-A W FP Iu=3200 VR VR UL	1SDA126247R1	E4A32VVXXXX	1SDA126248R1	ECA32VVXXXX
E6.3	H-A, V-A, L-A	4000 - 5000	HR - HR	E6.3-A W FP Iu=5000 HR HR UL	1SDA126249R1	E6A50HHXXXX	1SDA126250R1	EDA50HHXXXX
				E6.3-A/f W FP Iu=5000 HR HR UL ¹	-	-	1SDA126251R1	EEA50HHXXXX
	H-A, V-A, L-A	6000	VR - VR	E6.3-A W FP Iu=6000 VR VR UL	1SDA126252R1	E6A60VVXXXX	-	-

¹ 100% Neutral

Without terminals

Size	Performance	Amperage range	Terminal type	Type	3P		4P	
					Global PN	US / CA PN	Global PN	US / CA PN
E1.3	B-A, N-A, S-A	250-1200	None	E1.3-A W FP Iu=1200	1SDA130195R1	E1A12XXXXXX	1SDA130196R1	EAA12XXXXXX
E2.3	B-A, N-A, S-A, H-A, V-A	250-2000	None	E2.3-A W FP Iu=2000	1SDA130197R1	E2A20XXXXXX	1SDA130198R1	EBA20XXXXXX
E4.3	S-A, H-A, V-A	800-2500	None	E4.3-A W FP Iu=2500	1SDA130199R1	E4A25XXXXXX	1SDA130200R1	ECA25XXXXXX
	S-A, H-A, V-A	3200 (only)	None	E4.3-A W FP Iu=3200	1SDA130201R1	E4A32XXXXXX	1SDA130202R1	ECA32XXXXXX
E6.3	H-A, V-A	4000-5000	None	E6.3-A W FP Iu=5000	1SDA130205R1	E6A50XXXXXX	1SDA130204R1	EDA50XXXXXX
				E6.3-A/f W FP Iu=5000 ¹	-	-	1SDA130206R1	EEA50XXXXXX
	H-A, V-A	6000 (only)	None	E6.3-A W FP Iu=6000	1SDA130203R1	E6A60XXXXXX	-	-

¹ 100% Neutral

SACE Emax 3 low voltage power circuit breakers

Accessories
Control



First and second opening release - YO

Size	Type	Part Number	US / CA PN
E1.3...E6.3	YO E1.3...E6.3 24 Vac/dc	1SDA126253R1	K3A-ELEC-YOD
E1.3...E6.3	YO E1.3...E6.3 30 Vac/dc	1SDA126254R1	K3A-ELEC-YOF
E1.3...E6.3	YO E1.3...E6.3 48 Vac/dc	1SDA126255R1	K3A-ELEC-YOJ
E1.3...E6.3	YO E1.3...E6.3 60 Vac/dc	1SDA126256R1	K3A-ELEC-YOL
E1.3...E6.3	YO E1.3...E6.3 110-120 Vac/dc	1SDA126257R1	K3A-ELEC-YOA
E1.3...E6.3	YO E1.3...E6.3 120-127 Vac/dc	1SDA126258R1	K3A-ELEC-YOB
E1.3...E6.3	YO E1.3...E6.3 220-240 Vac/dc	1SDA126259R1	K3A-ELEC-YOC
E1.3...E6.3	YO E1.3...E6.3 240-250 Vac/dc	1SDA126260R1	K3A-ELEC-YOE
E1.3...E6.3	YO E1.3...E6.3 380-400 Vac	1SDA126261R1	K3A-ELEC-YOG
E1.3...E6.3	YO E1.3...E6.3 415-440 Vac	1SDA126262R1	K3A-ELEC-YOH
E1.3...E6.3	YO E1.3...E6.3 480-500 Vac	1SDA126263R1	K3A-ELEC-YOK



YO-Sense first and second opening release-Sense

Size	Type	Part Number	US / CA PN
E1.3...E6.3	YO-Sense 1st E1.3...E6.3 24-60 Vac/dc	1SDA126264R1	K3A-ELEC-YO-SN
E1.3...E6.3	YO-Sense 1st E1.3...E6.3 110-250 Vac/dc	1SDA126265R1	K3A-ELEC-YO-SM
E1.3...E6.3	YO-Sense 2nd E1.3...E6.3 24-60 Vac/dc	1SDA126266R1	K3A-ELEC-2YO-S9
E1.3...E6.3	YO-Sense 2nd E1.3...E6.3 110-250 Vac/dc	1SDA126267R1	K3A-ELEC-2YO-S8



First and second closing release - YC

Size	Type	Global PN	US / CA PN
E1.3...E6.3	YC E1.3...E6.3 24 Vac/dc	1SDA126268R1	K3A-ELEC-YCD
E1.3...E6.3	YC E1.3...E6.3 30 Vac/dc	1SDA126269R1	K3A-ELEC-YCF
E1.3...E6.3	YC E1.3...E6.3 48 Vac/dc	1SDA126270R1	K3A-ELEC-YCJ
E1.3...E6.3	YC E1.3...E6.3 60 Vac/dc	1SDA126271R1	K3A-ELEC-YCL
E1.3...E6.3	YC E1.3...E6.3 110-120 Vac/dc	1SDA126272R1	K3A-ELEC-YCA
E1.3...E6.3	YC E1.3...E6.3 120-127 Vac/dc	1SDA126273R1	K3A-ELEC-YCB
E1.3...E6.3	YC E1.3...E6.3 220-240 Vac/dc	1SDA126274R1	K3A-ELEC-YCC
E1.3...E6.3	YC E1.3...E6.3 240-250 Vac/dc	1SDA126275R1	K3A-ELEC-YCE
E1.3...E6.3	YC E1.3...E6.3 380-400 Vac	1SDA126276R1	K3A-ELEC-YCG
E1.3...E6.3	YC E1.3...E6.3 415-440 Vac	1SDA126277R1	K3A-ELEC-YCH
E1.3...E6.3	YC E1.3...E6.3 480-500 Vac	1SDA126278R1	K3A-ELEC-YCK

SACE Emax 3 low voltage power circuit breakers

Accessories
Control



First and second undervoltage release - YU

Size	Type	Part Number	US / CA PN
E1.3...E6.3	YU E1.3...E6.3 24 Vac/dc	1SDA126283R1	K3A-ELEC-YUD
E1.3...E6.3	YU E1.3...E6.3 30 Vac/dc	1SDA126284R1	K3A-ELEC-YUF
E1.3...E6.3	YU E1.3...E6.3 48 Vac/dc	1SDA126285R1	K3A-ELEC-YUJ
E1.3...E6.3	YU E1.3...E6.3 60 Vac/dc	1SDA126286R1	K3A-ELEC-YUL
E1.3...E6.3	YU E1.3...E6.3 110-120 Vac/dc	1SDA126287R1	K3A-ELEC-YUA
E1.3...E6.3	YU E1.3...E6.3 120-127 Vac/dc	1SDA126288R1	K3A-ELEC-YUB
E1.3...E6.3	YU E1.3...E6.3 220-240 Vac/dc	1SDA126289R1	K3A-ELEC-YUC
E1.3...E6.3	YU E1.3...E6.3 240-250 Vac/dc	1SDA126290R1	K3A-ELEC-YUE
E1.3...E6.3	YU E1.3...E6.3 380-400 Vac	1SDA126291R1	K3A-ELEC-YUG
E1.3...E6.3	YU E1.3...E6.3 415-440 Vac	1SDA126292R1	K3A-ELEC-YUH
E1.3...E6.3	YU E1.3...E6.3 440-500 Vac	1SDA126293R1	K3A-ELEC-YUK



YU-Sense first and second undervoltage release-Sense

Size	Type	Part Number	US / CA PN
E1.3...E6.3	YU-Sense 1st E1.3...E6.3 24 Vac/dc	1SDA126294R1	K3A-ELEC-YU-SP
E1.3...E6.3	YU-Sense 1st E1.3...E6.3 30 Vac/dc	1SDA126295R1	K3A-ELEC-YU-SR
E1.3...E6.3	YU-Sense 1st E1.3...E6.3 48 Vac/dc	1SDA126296R1	K3A-ELEC-YU-SS
E1.3...E6.3	YU-Sense 1st E1.3...E6.3 60 Vac/dc	1SDA126297R1	K3A-ELEC-YU-ST
E1.3...E6.3	YU-Sense 1st E1.3...E6.3 110-120 Vac/dc	1SDA126298R1	K3A-ELEC-YU-SM
E1.3...E6.3	YU-Sense 1st E1.3...E6.3 120-127 Vac/dc	1SDA126299R1	K3A-ELEC-YU-SN
E1.3...E6.3	YU-Sense 1st E1.3...E6.3 220-240 Vac/dc	1SDA126300R1	K3A-ELEC-YU-SO
E1.3...E6.3	YU-Sense 1st E1.3...E6.3 240-250 Vac/dc	1SDA126301R1	K3A-ELEC-YU-SQ
E1.3...E6.3	YU-Sense 2nd E1.3...E6.3 24 Vac/dc	1SDA126302R1	K3A-ELEC-2YU-S5
E1.3...E6.3	YU-Sense 2nd E1.3...E6.3 30 Vac/dc	1SDA126303R1	K3A-ELEC-2YU-S7
E1.3...E6.3	YU-Sense 2nd E1.3...E6.3 48 Vac/dc	1SDA126304R1	K3A-ELEC-2YU-S8
E1.3...E6.3	YU-Sense 2nd E1.3...E6.3 60 Vac/dc	1SDA126305R1	K3A-ELEC-2YU-S9
E1.3...E6.3	YU-Sense 2nd E1.3...E6.3 110-120 Vac/dc	1SDA126306R1	K3A-ELEC-2YU-S2
E1.3...E6.3	YU-Sense 2nd E1.3...E6.3 120-127 Vac/dc	1SDA126307R1	K3A-ELEC-2YU-S3
E1.3...E6.3	YU-Sense 2nd E1.3...E6.3 220-240 Vac/dc	1SDA126308R1	K3A-ELEC-2YU-S4
E1.3...E6.3	YU-Sense 2nd E1.3...E6.3 240-250 Vac/dc	1SDA126309R1	K3A-ELEC-2YU-S6

Electronic time-delay device for undervoltage release - UVD

Size	Type	Part Number	US / CA PN
E1.3...E6.3	UVD 24-30 Vdc	1SDA133771R1	K3A-ELEC-UVDD
E1.3...E6.3	UVD 48-60 Vac/dc	1SDA133772R1	K3A-ELEC-UVDE
E1.3...E6.3	UVD 110...125 Vac/dc	1SDA133769R1	K3A-ELEC-UVDA
E1.3...E6.3	UVD 220...250 Vac/dc	1SDA133770R1	K3A-ELEC-UVDC

Note: The electronic time-delay device must be used with an undervoltage coil with the same voltage

SACE Emax 3 low voltage power circuit breakers

Accessories
Control

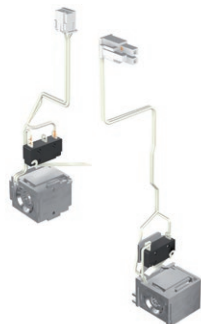

Remote reset - YR

Size	Type	Part Number	US / CA PN
E1.3	YR 24 Vdc E1.3	1SDA073744R1	ZE1YRA
E1.3	YR 110 Vac/dc E1.3 ¹	1SDA073745R1	ZE1YRB
E1.3	YR 220 Vac/dc E1.3 ¹	1SDA073746R1	ZE1YRC
E2.3..E6.3	YR 24 Vdc E2.3...E6.3	1SDA073747R1	ZEBYRA
E2.3..E6.3	YR 110 Vac/dc E2.3...E6.3 ¹	1SDA073748R1	ZEBYRB
E2.3..E6.3	YR 220 Vac/Dc E2.3...E6.3 ¹	1SDA073749R1	ZEBYRC

¹ When YR is used in DC, the activation of YR must be done with a maximum impulse time of 50ms. The YR cannot be powered permanently.



Motor - M

Size	Type	Part Number	US / CA PN
E1.3	M E1.3 24-30 Vac/dc + MC 250V	1SDA073708R1	ZE1M2
E1.3	M E1.3 48-60 Vac/dc + MC 250V	1SDA073709R1	ZE1M3
E1.3	M E1.3 100-130 Vac/dc + MC 250V	1SDA073710R1	ZE1M4
E1.3	M E1.3 220-250 Vac/dc + MC 250V	1SDA073711R1	ZE1M5
E1.3	M E1.3 380-415 Vac + MC 250V	1SDA073713R1	ZE1M7
E2.3..E6.3	M E2.3...E6.3 24-30 Vac/dc + MC 400V	1SDA073722R1	ZEBM2
E2.3..E6.3	M E2.3...E6.3 48-60 Vac/dc + MC 400V	1SDA073723R1	ZEBM3
E2.3..E6.3	M E2.3...E6.3 100-130 Vac/dc + MC 400V	1SDA073724R1	ZEBM4
E2.3..E6.3	M E2.3...E6.3 220-250 Vac/dc + MC 400V	1SDA073725R1	ZEBM5
E2.3..E6.3	M E2.3...E6.3 380-415 Vac + MC 400V	1SDA073727R1	ZEBM7
E1.3	M E1.3 24-30 Vac/dc + MC 24V	1SDA073715R1	ZE1MA
E1.3	M E1.3 48-60 Vac/dc + MC 24V	1SDA073716R1	ZE1MB
E1.3	M E1.3 100-130 Vac/dc + MC 24V	1SDA073717R1	ZE1MC
E1.3	M E1.3 220-250 Vac/dc + MC 24V	1SDA073718R1	ZE1MD
E1.3	M E1.3 380-415 Vac + MC 24V	1SDA073720R1	ZE1MF
E2.3..E6.3	M E2.3...E6.3 24-30 Vac/dc + MC 24V	1SDA073729R1	ZEBMA
E2.3..E6.3	M E2.3...E6.3 48-60 Vac/dc + MC 24V	1SDA073730R1	ZEBMB
E2.3..E6.3	M E2.3...E6.3 100-130 Vac/dc + MC 24V	1SDA073731R1	ZEBMC
E2.3..E6.3	M E2.3...E6.3 220-250 Vac/dc + MC 24V	1SDA073732R1	ZEBMD



M-Sense Enabler ¹

Size	Type	Part Number	US / CA PN
E1.3	M-Sense Enabler E1.3 24V-60V	1SDA126310R1	K31-ELEC-M-SF
E1.3	M-Sense Enabler E1.3 100V-415V	1SDA126311R1	K31-ELEC-M-SE
E2.3..E6.3	M-Sense Enabler E2.3...E6.3 24V-60V	1SDA126312R1	K3B-ELEC-M-SF
E2.3..E6.3	M-Sense Enabler E2.3...E6.3 100V-415V	1SDA126313R1	K3B-ELEC-M-SE

¹ Ekip Supply Lite is mandatory (in alternative Ekip Supply Evo Modbus TCP)



SACE Emax 3 low voltage power circuit breakers

Accessories

Measurement & Protection

Upgrades

Size	Type	Part Number	US / CA PN
E1.3...E6.3	Non defeatable I protection ¹	1SDA114799R1	Factory installed code only
E1.3...E6.3	Cybersecure breaker IEC 62443-4-2 ¹	1SDA126529R1	F3A-EK-CYBERSECURE
E1.3...E6.3	Predictive maintenance on-premise ²	1SDA126531R1	F3A-SW-PREDMAINT
E1.3...E6.3	Internal temperature control ²	1SDA126532R1	F3A-EK-INTEMP

¹ Only supplied with the circuit-breaker.

² Only supplied with the circuit-breaker. It is not available with the Neutral on the right-side configuration. Auxiliary supply (Ekip Supply Lite or Ekip Supply Evo Modbus TCP) is needed



Current sensor for neutral conductor outside the circuit-breaker ¹

Size	Type	Part Number	US / CA PN
E1.3-E2.3	Ext CS N E1.3 - E2.3 UL	1SDA126319R1	K32-ELEC-NCT2000
E4.3-E6.3	Ext CS N E4.3 - E6.3 50% UL	1SDA126320R1	K34-ELEC-NCT3200
E6.3	Ext CS N E6.3 100% UL	1SDA126321R1	K36-ELEC-NCT6000
E1.3-E2.3-E4.3	Ext CS N E1.3-E2.3-E4.3 10mt cable ²	1SDA126322R1	K34-ELEC-ENCTCABLE
E6.3	Ext CS N E6.3 10mt cable (2)	1SDA128406R1	K36-ELEC-ENCTCABLE
E1.3...E6.3	External openable CS N CT100	1SDA126327R1	K3A-ELEC-NCT100
E1.3...E6.3	External openable CS N CT120	1SDA126328R1	K3A-ELEC-NCT120
E1.3...E6.3	External openable CS N CT200	1SDA126329R1	K3A-ELEC-NCT200
E1.3...E6.3	External openable CS N CT290	1SDA126330R1	K3A-ELEC-NCT290
E1.3...E6.3	Positioning device	1SDA085570R1	

¹ Only loose

² Only for Ext CS N version

Fixed or mobile part with neutral on the right side

Size	Type	Part Number 4-poles
E1.3...E6.3	Installation with neutral on right side sequence L1,L2,L3,N ¹	1SDA076153R1

¹ When this configuration is selected the circuit-breaker is not certified for IEC 61557-12 (Class 0.5 and class 1 accuracy)

Homopolar toroid for Gext protection ^{1,2}

Size	Type	Part Number	US / CA PN
E1.3...E6.3	Homopolar toroid E1.3...E6.3 100A	1SDA127755R1	K3A-ELEC-SGR100
E1.3...E6.3	Homopolar toroid E1.3...E6.3 250A	1SDA127762R1	K3A-ELEC-SGR250
E1.3...E6.3	Homopolar toroid E1.3...E6.3 400A	1SDA127763R1	K3A-ELEC-SGR400
E1.3...E6.3	Homopolar toroid E1.3...E6.3 800A	1SDA127764R1	K3A-ELEC-SGR800
E1.3...E6.3	Homopolar toroid E1.3...E6.3 1200A	1SDA126331R1	K3A-ELEC-SGR1200

¹ Only loose

² The homopolar toroid is an alternative to the toroid for differential protection (RC)

Toroid for differential protection (Rc residual current protection) ^{1,2}

Size	Type	Part Number	US / CA PN
E1.3 & E2.3 3p	Toroid RC E1.3, E2.3 3p	1SDA126332R1	K32-ELEC-RCTOROID
E2.3 4p & E4.3	Toroid RC E2.3 4p, E4.3 3p	1SDA126333R1	K34-ELEC-RCTOROID

¹ Only loose

² The toroid for differential protection is an alternative to the homopolar toroid



SACE Emax 3 low voltage power circuit breakers

Accessories

Measurement & Protection



Dedicated terminal for Modified Differential Ground Fault (MDGF) protection

Size	Type	Part Number	US / CA PN
E1.3...E6.3	MDGF Terminal for fixed circuit-breaker ¹	1SDA114800R1	ZEAMDGFF
E1.3...E6.3	MDGF Terminal for withdrawable circuit-breaker ¹	1SDA114798R1	ZEAMDGFW

¹ The commercial Part Number includes one piece.

Note: External phase current transformers and summing current transformers must be purchased separately. If the terminal for MDGF is bought after sales, FP connector for 3-pin/5-pin terminal block must be ordered

Metering ¹

Size	Type	Part Number	US / CA PN
E1.3	Class 0.5 Power&Energy Metering E1.3	1SDA126537R1	F31-EK-CLASS05
E2.3	Class 0.5 Power&Energy Metering E2.3	1SDA126538R1	F32-EK-CLASS05
E4.3	Class 0.5 Power&Energy Metering E4.3	1SDA126539R1	F34-EK-CLASS05
E6.3	Class 0.5 Power&Energy Metering E6.3	1SDA126540R1	F36-EK-CLASS05
E1.3	Class 1 Power&Energy Metering E1.3	1SDA132663R1	F31-EK-CLASS1
E2.3	Class 1 Power&Energy Metering E2.3	1SDA132664R1	F32-EK-CLASS1
E4.3	Class 1 Power&Energy Metering E4.3	1SDA132665R1	F34-EK-CLASS1
E6.3	Class 1 Power&Energy Metering E6.3	1SDA132666R1	F36-EK-CLASS1

¹ Available only if supplied with the circuit breaker; the Measuring Digital upgrade is mandatory. The performance values in the table apply to circuit breakers supplied with an auxiliary power supply (Ekip Supply or Ekip Supply Evo Modbus TCP), with a frame size (Iu) ≥ 630 A, Un ≥ 400 V, internal voltage cables only, and with phase sequence 1-2-3 only. They are also valid for 3-pole circuit breakers (without external neutral sensor) or 4-pole circuit breakers (only if the neutral is on the left).

Digital Rating Plug ¹

Size	Type	Part Number	US / CA PN
E1.3...E6.3	Digital Rating Plug 100A	1SDA126541R1	F32-EK-RP100
E1.3...E6.3	Digital Rating Plug 200A	1SDA126542R1	F32-EK-RP200
E1.3...E6.3	Digital Rating Plug 250A	1SDA126543R1	F32-EK-RP250
E1.3...E6.3	Digital Rating Plug 400A	1SDA126544R1	F3A-EK-RP400
E1.3...E6.3	Digital Rating Plug 630A	1SDA126546R1	F3A-EK-RP630
E1.3...E6.3	Digital Rating Plug 800A	1SDA126547R1	F3A-EK-RP800
E1.3...E6.3	Digital Rating Plug 1000A	1SDA126548R1	F3A-EK-RP1000
E1.3...E6.3	Digital Rating Plug 1250A	1SDA126550R1	F3A-EK-RP1250
E1.3...E6.3	Digital Rating Plug 1600A	1SDA126551R1	F3A-EK-RP1600
E2.3...E6.3	Digital Rating Plug 2000A	1SDA126552R1	F3B-EK-RP2000
E2.3...E6.3	Digital Rating Plug 2500A	1SDA126553R1	F3B-EK-RP2500
E4.3...E6.3	Digital Rating Plug 3000A	1SDA126554R1	F3B-EK-RP3000
E4.3...E6.3	Digital Rating Plug 3200A	1SDA126555R1	F3B-EK-RP3200
E4.3...E6.3	Digital Rating Plug 4000A	1SDA126557R1	F3B-EK-RP4000
E6.3	Digital Rating Plug 5000A	1SDA126558R1	F36-EK-RP5000

¹ Only supplied with the circuit-breaker

SACE Emax 3 low voltage power circuit breakers

Accessories

Signalling & Input/Output

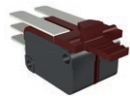

Open closed auxiliary contacts - AUX

Size	Type	Part Number	US / CA PN
E1.3	AUX 4Q (4 Form C) 400V E1.3 ^{4,6}	1SDA073750R1	ZE1AUX4
E1.3	AUX 4Q (4 Form C) 24V E1.3 ⁵	1SDA073751R1	ZE1AUX4D
E1.3	AUX 2Q (2 Form C) 400V + 2Q (2 Form C) 24V E1.3 ⁶	1SDA073752R1	ZE1AUX2-2D
E2.3..E6.3	AUX 4Q (4 Form C) 400V E2.3...E6.3 ⁴	1SDA073753R1	ZEB AUX4
E2.3..E6.3	AUX 4Q (4 Form C) 24V E2.3...E6.3 ⁵	1SDA073754R1	ZEB AUX4D
E2.3..E6.3	AUX 2Q (2 Form C) 400V + 2Q (2 Form C) 24V E2.3...E6.3 ⁶	1SDA073755R1	ZEB AUX2-2D
E2.3..E6.3	AUX 6Q 400V E2.3...E6.3 F (1) ⁶	1SDA126334R1	K3B-AUX6QAF
E2.3..E6.3	AUX 6Q 400V E2.3...E6.3 W (1) ⁶	1SDA127790R1	K3B-AUX6QAW
E2.3..E6.3	AUX 6Q 24V E2.3...E6.3 F (1) ⁵	1SDA126335R1	K3B-AUX6QDF
E2.3..E6.3	AUX 6Q 24V E2.3...E6.3 W (1) ⁵	1SDA127791R1	K3B-AUX6QDW
E2.3..E6.3	AUX 3Q (3 Form C) 400V + 3Q (3 Form C) 24V E2.3...E6.3 F ¹	1SDA126340R1	K3B-AUX3-3QCF
E2.3..E6.3	AUX 3Q (3 Form C) 400V + 3Q (3 Form C) 24V E2.3...E6.3 W ¹	1SDA127792R1	K3B-AUX3-3QCW
E1.3	AUX 15Q (15 Form C) 400V E1.3 ^{2,3,6}	1SDA073758R1	ZE1AUX15
E1.3	AUX 15Q (15 Form C) 24V E1.3 ^{2,3,5}	1SDA073759R1	ZE1AUX15D
E2.3..E6.3	AUX 15Q (15 Form C) 400V (for fixed/drawout with signalling in racked in) E2.3...E6.3 ^{2,3,6}	1SDA126336R1	K3B-AUX15QCONAW
E2.3..E6.3	AUX 15Q (15 Form C) 24V (for fixed/drawout with signalling in racked in) E2.3...E6.3 ^{2,3,5}	1SDA126337R1	K3B-AUX15QCONDW
E2.3..E6.3	AUX 15Q (15 Form C) 400V (for fixed/drawout with signalling in racked in/test isolated) E2.3...E6.3 ^{2,3,6}	1SDA126338R1	K3B-AUX15QAW
E2.3..E6.3	AUX 15Q (15 Form C) 24V (for fixed/drawout with signalling in racked in/test isolated) E2.3...E6.3 ^{2,3,5}	1SDA126339R1	K3B-AUX15QDW

¹ AUX 6Q (6 Form C) is an alternative to the Ekip Signalling 4k module

² AUX 15 Q (15 Form C) is an alternative to the Mechanical interlock (MI), the lock to prevent door opening when the circuit-breaker is in the racked in or test position (DCP) when mounted on the right side. For E1.3 one of the mounting plates is also needed. For E1.3 you need to order also one of the following items:

Plate for fixed - floor mounted	1SDA079783R1	ZE1AUX15PLF
Plate for fixed - wall mounted	1SDA079782R1	ZE1AUX15PLW
Plate for withdrawable	1SDA079784R1	ZE1AUX15PLMP

³ Not compatible with mechanical locks on compartment doors or mechanical interlocks

⁴ Standard supply with automatic circuit-breakers

⁵ Max load 0.1 A

⁶ Max working voltage 400V

SACE Emax 3 low voltage power circuit breakers

Accessories

Signalling & Input/Output



Auxiliary position contacts - AUP

Size	Type	Part Number	US / CA PN
E1.3	AUP 6 contacts 400V E1.3 2I/2T/2E - right set	1SDA141030R1	ZE1AUP
E1.3	AUP 6 contacts 24V E1.3 2I/2T/2E - right set ¹	1SDA141029R1	ZE1AUPD
E1.3	AUP 6 contacts 400V E1.3 6I - right set	1SDA135119R1	
E1.3	AUP 6 contacts 24V E1.3 6I - right set	1SDA135120R1	
E1.3...E6.3	AUP Ekip auxiliary position contact E1.3...E6.3	1SDA073768R1	ZEAAUPE
E2.3...E6.3	AUP 5 contacts 400V E2.3...E6.3 2I1T2E - left set ²	1SDA126341R1	K3B-AUP-5AL-2I1T2E
E2.3...E6.3	AUP 5 contacts 24V E2.3...E6.3 2I1T2E - left set ¹	1SDA126342R1	K3B-AUP-5DL-2I1T2E
E2.3...E6.3	AUP 5 contacts 24Vdc E2.3...E6.3 4I1E - left set	1SDA135292R1	
E2.3...E6.3	AUP 5 contacts 400Vac E2.3...E6.3 4I1E - left set	1SDA135293R1	
E2.3...E6.3	AUP 5 contacts 400V E2.3...E6.3 2I1T2E - right set ²	1SDA126343R1	K3B-AUP-5AR-2I1T2E
E2.3...E6.3	AUP 5 contacts 24V E2.3...E6.3 2I1T2E - right set ¹	1SDA126344R1	K3B-AUP-5DR-2I1T2E
E2.3...E6.3	AUP 5 contacts 400V E2.3...E6.3 1I3T1E - right set ²	1SDA126345R1	K3B-AUP-5AR-1I3T1E
E2.3...E6.3	AUP 5 contacts 400V E2.3...E6.3 2I1T2E - left set Fast Contact ²	1SDA126346R1	K3B-AUP-5AL-2I1T2EFC
E2.3...E6.3	AUP 5 contacts 24V E2.3...E6.3 2I1T2E - left set Fast Contact ¹	1SDA126347R1	K3B-AUP-5DL-2I1T2EFC
E2.3...E6.3	AUP 5 contacts 400V E2.3...E6.3 4I/1E - left set Fast Contact ²	1SDA126348R1	K3B-AUP-5DLFC
E2.3...E6.3	AUP 5 contacts 24V E2.3...E6.3 4I/1E - left set Fast Contact ¹	1SDA126349R1	K3B-AUP-5ALFC
E2.3...E6.3	AUP 5 contacts. 400V E2.3...E6.3 2I1T2E - right set Fast Contact ^{2,3}	1SDA126350R1	K3B-AUP-5AR-2I1T2EFC
E2.3...E6.3	AUP 5 contacts 24V E2.3...E6.3 2I1T2E - right set Fast Contact ^{1,3}	1SDA126351R1	K3B-AUP-5DR-2I1T2EFC
E2.3...E6.3	AUP 5 contacts 400Vac E2.3...E6.3 1I3T1E - right set Fast Contact ^{2,3}	1SDA126352R1	K3B-AUP-5AR-1I3T1EFC

¹ Max load 0.1 A

² Max working voltage 400V

³ Right Fast AUP is not compatible with mechanical interlocks, 15Q, DLC and right DLP



Ready to close signalling contact - RTC

Size	Type	Part Number	US / CA PN
E1.3	RTC 250V E1.3	1SDA126353R1	K31-AUXRTCA
E1.3	RTC 24V E1.3	1SDA126354R1	K31-AUXRTCB
E1.3	RTC Ekip 24V E1.3	1SDA126355R1	K31-COM-EKRTC
E2.3...E6.3	RTC 250V E2.3...E6.3	1SDA126356R1	K3B-AUXRTCA
E2.3...E6.3	RTC 24V E2.3...E6.3	1SDA126357R1	K3B-AUXRTCB
E2.3...E6.3	RTC Ekip 24V E2.3...E6.3	1SDA126358R1	K3B-COM-EKRTC

Contact signalling tripping of Ekip protection trip unit - S51

Size	Type	Part Number	US / CA PN
E1.3	S51 / bell alarm 250V E1.3 ¹	1SDA073776R1	ZE1BA
E1.3	S51 / bell alarm 24V E1.3	1SDA073777R1	ZE1BAD
E2.3...E6.3	S51 / bell alarm 250V E2.3...E6.3 ¹	1SDA073778R1	ZEBBA
E2.3...E6.3	S51 / bell alarm 24V E2.3...E6.3	1SDA073779R1	ZEBBAD
E2.3...E6.3	250V E2.3...E6.3	1SDA085699R1	ZEBBA2
E2.3...E6.3	24V E2.3...E6.3	1SDA085700R1	ZEBBAD2

¹ Standard supply with automatic circuit-breakers

SACE Emax 3 low voltage power circuit breakers

Accessories

Signalling & Input/Output



Terminal blocks for auxiliary connection

Size	Type	Part Number	US / CA PN
E1.3...E6.3	3 pin terminal blocks 10 pcs ¹	1SDA073906R1	ZEATB10
E1.3...E6.3	3 pin terminal blocks 8 pcs INST ²	1SDA114779R1	F3A-AUX8TB3PIN
E1.3...E6.3	3 pin terminal blocks 18 pcs INST ²	1SDA114780R1	F3A-AUX18TB3PIN
E1.3...E6.3	Replacement 3-pin to 5-pin terminals INST ^{2,3}	1SDA126359R1	F3A-AUXINSTB5PIN
E1.3...E6.3	5 pin terminal blocks 10pcs ¹	1SDA126360R1	K3A-AUX10TB5PIN
E1.3...E6.3	5 pin terminal blocks 8pcs INST ²	1SDA126361R1	F3A-AUX8TB5PIN
E1.3...E6.3	5 pin terminal blocks 18pcs INST ²	1SDA126362R1	F3A-AUX18TB5PIN

¹ Only as Loose part

² Only supplied with the circuit-breaker

³ All 3-pin terminal blocks are substituted with 5-pin terminal blocks

Fixed part connector

Size	Type	Part Number	US / CA PN
E1.3...E6.3	FP connector for 3-pin/5-pin terminal block ¹	1SDA134296R1	NA

¹ the kit contains 4 connectors. Only for W circuit breaker

SACE Emax 3 low voltage power circuit breakers

Accessories

Safety & IP Protection



Mechanical operation counter - MOC

Size	Type	Part Number	US / CA PN
E1.3	MOC mechanical operation counter ¹	1SDA073780R1	ZE1MOC
E2.3...E6.3	MOC mechanical operation counter	1SDA143402R1	K3B-MECH-MOC

¹ Available with motor, for installation without Motor the support 1SDA126565R1 is required



Key lock in open position - KLC

Size	Type	Part Number	US / CA PN
E1.3	1st KLC-D Key lock open E1.3	1SDA126363R1	K31-MECH-1KLCD
E1.3	2nd KLC-D Key lock open E1.3	1SDA126364R1	K31-MECH-2KLCD
E1.3	KLC-S Key lock open N.20005 E1.3	1SDA126365R1	K31-MECH-KLCS5
E1.3	KLC-S Key lock open N.20006 E1.3	1SDA126366R1	K31-MECH-KLCS6
E1.3	KLC-S Key lock open N.20007 E1.3	1SDA126367R1	K31-MECH-KLCS7
E1.3	KLC-S Key lock open N.20008 E1.3	1SDA126368R1	K31-MECH-KLCS8
E1.3	KLC-S Key lock open N.20009 E1.3	1SDA126369R1	K31-MECH-KLCS9
E1.3	1st KLC-A Key lock open Castell E1.3 ^{1,2}	1SDA126371R1	K31-MECH-1KLCAK
E1.3	1st KLC-A Key lock open Kirk - STI E1.3 ^{1,3}	1SDA126372R1	K31-MECH-1KLCAK
E1.3	1st KLC-D Key lock open Ronis E1.3	1SDA126370R1	K31-MECH-1KLCDR
E2.3...E6.3	1st KLC-D Key lock open E2.3...E6.3	1SDA126373R1	K3B-MECH-1KLCD
E2.3...E6.3	2nd KLC-D Key lock open E2.3...E6.3	1SDA126374R1	K3B-MECH-2KLCD
E2.3...E6.3	KLC-S Key lock open N.20005 E2.3...E6.3	1SDA126375R1	K3B-MECH-KLCS5
E2.3...E6.3	KLC-S Key lock open N.20006 E2.3...E6.3	1SDA126376R1	K3B-MECH-KLCS6
E2.3...E6.3	KLC-S Key lock open N.20007 E2.3...E6.3	1SDA126377R1	K3B-MECH-KLCS7
E2.3...E6.3	KLC-S Key lock open N.20008 E2.3...E6.3	1SDA126378R1	K3B-MECH-KLCS8
E2.3...E6.3	KLC-S Key lock open N.20009 E2.3...E6.3	1SDA126379R1	K3B-MECH-KLCS9
E2.3...E6.3	1st KLC-A Key lock open Castell E2.3...E6.3 ^{1,2}	1SDA126382R1	K3B-MECH-1KLCAK
E2.3...E6.3	1st KLC-A Key lock open Kirk-STI E2.3...E6.3 ³	1SDA126383R1	K3B-MECH-1KLCAK
E2.3...E6.3	2nd KLC-A Key lock open Kirk-STI E2.3...E6.3 ^{1,3}	1SDA126384R1	K3B-MECH-2KLCAK
E2.3...E6.3	1st KLC-D Key lock open Ronis E2.3...E6.3	1SDA126380R1	K3B-MECH-1KLCDR
E2.3...E6.3	2nd KLC-D Key lock open Ronis E2.3...E6.3	1SDA126381R1	K3B-MECH-2KLCDR

¹ Arrangement only

² If purchased as a loose supply, the dedicated cover must also be ordered separately. Compatible models: Castell PDS05693-FSB, PDS05693-FSS, PDS05693-QB, PDS05693-QS

³ Compatible models: STI ABA90GEL5000 - STI HBA90GPS5000



SACE Emax 3 low voltage power circuit breakers

Accessories

Safety & IP Protection



Padlocks in open position - PLC

Size	Type	Part Number	US / CA PN
E1.3	1st PLC E1.3 Padlocks open pos. left	1SDA126385R1	K31-MECH-1PLC
E1.3	2nd PLC E1.3 Padlocks open pos. right	1SDA126386R1	K31-MECH-2PLC
E2.3...E6.3	1st PLC E2.3..E6.3 Padlocks open pos. left	1SDA126387R1	K3B-MECH-1PLC
E2.3...E6.3	2nd PLC E2.3..E6.3 Padlocks open pos. right	1SDA126388R1	K3B-MECH-2PLC

Note: The lock shackle/shank diameter must match for proper operation as indicated in the Instruction Manual.
The PLC is an alternative to the protection device for opening and closing pushbuttons (PBC)

Floor fixing plate - F ¹

Size	Type	Part Number	US / CA PN
E1.3	Floor fixing plate for fixed unit	1SDA076020R1	ZE1FFPF

¹ Only available with Motor, for installation without Motor the support 1SDA126565R1 is required

SACE Emax 3 low voltage power circuit breakers

Accessories

Safety & IP Protection

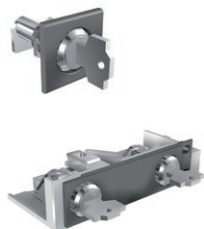

Key lock in racked in / test / racked out position - KLP

Size	Type	Part Number	US / CA PN
E1.3	KLP-D Key lock racked in/out E1.3 1st key	1SDA126389R1	K31-MECH-1KLDP
E1.3	KLP-S Key lock racked in/out N.20005 E1.3 1st key	1SDA126390R1	K31-MECH-1KLPS5
E1.3	KLP-S Key lock racked in/out N.20006 E1.3 1st key	1SDA126391R1	K31-MECH-1KLPS6
E1.3	KLP-S Key lock racked in/out N.20007 E1.3 1st key	1SDA126392R1	K31-MECH-1KLPS7
E1.3	KLP-S Key lock racked in/out N.20008 E1.3 1st key	1SDA126393R1	K31-MECH-1KLPS8
E1.3	KLP-S Key lock racked in/out N.20009 E1.3 1st key	1SDA126394R1	K31-MECH-1KLPS9
E1.3	KLP-D Key lock racked in/out E1.3 2nd key	1SDA126395R1	K31-MECH-2KLDP
E1.3	KLP-S Key lock racked in/out N.20005 E1.3 2nd key	1SDA126396R1	K31-MECH-2KLPS5
E1.3	KLP-S Key lock racked in/out N.20006 E1.3 2nd key	1SDA126397R1	K31-MECH-2KLPS6
E1.3	KLP-S Key lock racked in/out N.20007 E1.3 2nd key	1SDA126398R1	K31-MECH-2KLPS7
E1.3	KLP-S Key lock racked in/out N.20008 E1.3 2nd key	1SDA126399R1	K31-MECH-2KLPS8
E1.3	KLP-S Key lock racked in/out N.20009 E1.3 2nd key	1SDA126400R1	K31-MECH-2KLPS9
E1.3	KLP-A Key lock racked in/out Kirk-STI E1.3 1st key ⁴	1SDA126401R1	K31-MECH-1KLPAK
E1.3	KLP-A Key lock racked in/out Kirk-STI E1.3 2nd key ⁴	1SDA126402R1	K31-MECH-2KLPAK
E1.3	KLP-A Key lock racked in/out Castell E1.3 1st key ^{2,3}	1SDA126403R1	K31-MECH-1KLPAK
E1.3	KLP-A Key lock racked in/out Castell E1.3 2nd key ^{2,3}	1SDA126404R1	K31-MECH-2KLPAK
E1.3	KLP-A Key lock racked in/out Ronis E1.3 1st key	1SDA126405R1	K31-MECH-1KLPR
E1.3	KLP-A Key lock racked in/out Ronis E1.3 2nd key	1SDA126406R1	K31-MECH-2KLPR
E2.3...E6.3	KLP-D Key lock racked in/out E2.3...E6.3 1st key	1SDA126407R1	K3B-MECH-1KLDP
E2.3...E6.3	KLP-S Key lock racked in/out N.20005 E2.3...E6.3 1st key	1SDA126408R1	K3B-MECH-1KLPS5
E2.3...E6.3	KLP-S Key lock racked in/out N.20006 E2.3...E6.3 1st key	1SDA126409R1	K3B-MECH-1KLPS6
E2.3...E6.3	KLP-S Key lock racked in/out N.20007 E2.3...E6.3 1st key	1SDA126410R1	K3B-MECH-1KLPS7
E2.3...E6.3	KLP-S Key lock racked in/out N.20008 E2.3...E6.3 1st key	1SDA126411R1	K3B-MECH-1KLPS8
E2.3...E6.3	KLP-S Key lock racked in/out N.20009 E2.3...E6.3 1st key	1SDA126412R1	K3B-MECH-1KLPS9
E2.3...E6.3	KLP-D Key lock racked in/out E2.3...E6.3 2nd key	1SDA126413R1	K3B-MECH-2KLDP
E2.3...E6.3	KLP-S Key lock racked in/out N.20005 E2.3...E6.3 2nd key	1SDA126414R1	K3B-MECH-2KLPS5
E2.3...E6.3	KLP-S Key lock racked in/out N.20006 E2.3...E6.3 2nd key	1SDA126415R1	K3B-MECH-2KLPS6
E2.3...E6.3	KLP-S Key lock racked in/out N.20007 E2.3...E6.3 2nd key	1SDA126416R1	K3B-MECH-2KLPS7
E2.3...E6.3	KLP-S Key lock racked in/out N.20008 E2.3...E6.3 2nd key	1SDA126417R1	K3B-MECH-2KLPS8
E2.3...E6.3	KLP-S Key lock racked in/out N.20009 E2.3...E6.3 2nd key	1SDA126418R1	K3B-MECH-2KLPS9
E2.3...E6.3	KLP-A Key lock racked in/out Kirk-STI E2.3...E6.3 1st key ^{2,4}	1SDA126419R1	K3B-MECH-1KLPAK
E2.3...E6.3	KLP-A Key lock racked in/out Kirk-STI E2.3...E6.3 2nd key ^{2,4}	1SDA126420R1	K3B-MECH-2KLPAK
E2.3...E6.3	KLP-A Key lock racked in/out Castell E2.3...E6.3 1st key ^{1,2,3}	1SDA126421R1	K3B-MECH-1KLPAK
E2.3...E6.3	KLP-A Key lock racked in/out Castell E2.3...E6.3 2nd key ^{1,2,3}	1SDA126422R1	K3B-MECH-2KLPAK
E2.3...E6.3	KLP-D Key lock racked in/out Ronis E2.3/E6.3 1st key	1SDA126423R1	K3B-MECH-1KLPR
E2.3...E6.3	KLP-D Key lock racked in/out Ronis E2.3/E6.3 2nd key	1SDA126424R1	K3B-MECH-2KLPR

Note: To have 2 keys, one each of a 1st key and 2nd key option must be ordered.

When the Padlock in racked in/test/racked out (PLP) is also present, the 2nd key option must be ordered.

¹ Two Castell key options can not be used together

² Arrangement only

³ Compatible models: Castell PDS05693-FSB, PDS05693-FSS, PDS05693-QB, PDS05693-QS

⁴ Compatible models: STI ABA90GEL5000 - STI HBA90GPS5000 - KIRK KCAM00011

SACE Emax 3 low voltage power circuit breakers

Accessories

Safety & IP Protection



Accessory for supplementary lock in racked-out position

Size	Type	Part Number	US / CA PN
E1.3	Suppl. lock in racked out E1.3 ¹	1SDA073838R1	ZE1SUP
E2.3...E6.3	Suppl. lock in racked out E2.3...E6.3	1SDA073839R1	ZEBSUP

¹ Not compatible with Castell KLP

Padlock in racked in / test / racked out position - PLP

Size	Type	Part Number	US / CA PN
E1.3	PLP Padlock racked in/out E1.3	1SDA073840R1	ZE1PLP
E2.3...E6.3	PLP Padlock racked in/out E2.3...E6.3	1SDA126425R1	K3B-MECH-PLP

Note: The lock shackle/shank diameter must match for proper operation.



Lock for racking in / racking out the mobile part when the door is open - DLR ¹

Size	Type	Part Number
E1.3...E6.3	DLR E2.3...E6.3	1SDA073845R1

¹ Only as loose part



Lock to prevent door opening when the circuit-breaker is in racked in / test position - DLP ¹

Size	Type	Part Number	US / CA PN
E1.3	DLP E1.3 Left	1SDA114338R1	K31-MECH-DLPL
E2.3...E6.3	DLP E2.3...E6.3 Left	1SDA126427R1	K3B-MECH-DLPL
E2.3...E6.3	DLP E2.3...E6.3 Right ²	1SDA128407R1	K3B-MECH-DLPR

¹ Only as loose part

² Right DLP is not compatible with mechanical interlocks, 15Q, DLC and fast AUP right

Lock to prevent door opening when the circuit-breaker is in a closed position - DLC

Size	Type	Part Number	US / CA PN
E1.3	DLC Interlock cable door for fixed part withdrawable E1.3	1SDA081034R1	ZE1DLCCDFP
E1.3	DLC Interlock direct door for fixed to wall E1.3	1SDA079779R1	ZE1DLCCDFW
E1.3	DLC Interlock direct door for fixed part withdrawable E1.3	1SDA079781R1	ZE1DLCCDFP
E2.3...E6.3	DLC Interlock direct door E2.3...E6.3 F ¹	1SDA126428R1	K3B-MECH-DLCCF
E2.3...E6.3	DLC Interlock direct door E2.3...E6.3 W ¹	1SDA129641R1	K3B-MECH-DLCDW

Note: If mounted on the right side, the DLP is an alternative to the mechanical interlock, AUX 15Q (15 Form C) or Lock to prevent door opening when the circuit-breaker is in a closed position (DLC);

¹ To be ordered with lever for interlock [group 2] and support for interlock [1SDA126457R1]

SACE Emax 3 low voltage power circuit breakers

Accessories

Safety & IP Protection



Protection device for opening and closing pushbuttons - PBC

Size	Type	Part Number	US / CA PN
E1.3	PBC Op/Cl Pushbutton Protection sp. key E1.3	1SDA126429R1	K31-MECH-PBC
E1.3	PBC Op/Cl Pushbutton Protection PL D=4mm/0.15" E1.3	1SDA126430R1	K31-MECH-PBC4
E1.3	PBC Op/Cl Pushbutton Protection PL D=7mm/0.27" E1.3	1SDA126431R1	K31-MECH-PBC7
E1.3	PBC Op/Cl Pushbutton Protection PL D=8mm/0.31" E1.3	1SDA126432R1	K31-MECH-PBC8
E2.3...E6.3	PBC Op/Cl Pushbutton Protection sp. key E2.3...E6.3	1SDA126433R1	K3B-MECH-PBC
E2.3...E6.3	PBC Op/Cl Pushbutton Protection PL D=4mm/0.15" E2.3...E6.3	1SDA126435R1	K3B-MECH-PBC4
E2.3...E6.3	PBC Op/Cl Pushbutton Protection PL D=7mm/0.27" E2.3...E6.3	1SDA126436R1	K3B-MECH-PBC7
E2.3...E6.3	PBC Op/Cl Pushbutton Protection PL D=8mm/0.31" E2.3...E6.3	1SDA126437R1	K3B-MECH-PBC8
E2.3...E6.3	PBC2 Closing Pushbutton Protection E2.3...E6.3	1SDA126434R1	K3B-MECH-PBCCL

Note: The lock shackle/shank diameter must match for proper operation



Circuit-breaker flange

Size	Type	Part Number	US / CA PN
E1.3	IP30 flange E1.3 Fixed	1SDA073862R1	ZE1FLG30F
E1.3	IP30 flange E1.3 Drawout	1SDA073863R1	ZE1FLG30D
E2.3...E6.3	IP30 flange E2.3...E6.3 Fixed	1SDA073864R1	ZEBFLG30F
E2.3...E6.3	IP30 flange E2.3...E6.3 Drawout	1SDA073865R1	ZEBFLG30D
E1.3	IP30 blind door E1.3	1SDA126438R1	K31-MECH-IP30
E2.3...E6.3	IP30 blind door E2.3...E6.3	1SDA126439R1	K3B-MECH-IP30
E1.3	IP54 flange, different keys E1.3 ¹	1SDA073866R1	ZE1FLG54DK
E2.3...E6.3	IP54 flange, different keys E2.3...E6.3 ¹	1SDA073867R1	ZEBFLG54DK
E1.3	IP54 flange, key N.20005 E1.3 ¹	1SDA073868R1	ZE1FLG54SK
E2.3...E6.3	IP54 flange, key N.20005 E2.3...E6.3 ¹	1SDA073869R1	ZEBFLG54SK

¹ Only as loose part

Transparent trip unit cover

Size	Type	Part Number	US / CA PN
E1.3	Closed trip unit cover E1.3	1SDA126440R1	K31-MECH-STUCOVER
E2.3...E6.3	Sealable closed trip unit cover E2.3...E6.3	1SDA126441R1	K3B-MECH-STUCOVER
E2.3...E6.3	Closed trip unit cover E2.3...E6	1SDA128250R1	K3B-MECH-CLTUCOVER

SACE Emax 3 low voltage power circuit breakers

Accessories

Safety & IP Protection



Remote Racking Device - RRD

Size	Type	Part Number	US / CA PN
E1.3	RRD Motor 110-220 Vac/dc ²	1SDA126190R1	K31-ELEC-RRDM
E1.3	Kit for fixing RRD on E1.3 ¹	1SDA126191R1	K31-MECH-RRD
E2.3...E6.3	RRD Motor 110-220Vac/dc ²	1SDA126192R1	K3B-ELEC-RRDM
E2.3...E6.3	Kit for fixing RRD on E2.3...E6.3 ¹	1SDA126193R1	K3B-MECH-RRD
E1.3...E6.3	RRD controller ³	1SDA126194R1	K3A-ELEC-RRDC

¹ One kit per breaker needed

² It includes Motor, power supply and controller

³ It includes a controller that can be used either for the external RRD solution or for the embedded RRD-E solution. Only in the latter case, an adapter (included in the kit) and four AA batteries (not included in the kit) are needed.



Remote Racking Device EMBEDDED - RRD-E ¹

Size	Type	Part Number	US / CA PN
E4.3	RRD Embedded 24 V	1SDA127015R1	F34-ELEC-RRDE
E6.3	RRD Embedded 24 V	1SDA127016R1	F36-ELEC-RRDE

¹ Only supplied with the circuit-breaker or the switch disconnecter

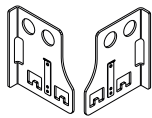

Lifting plates ¹

Size	Poles	IEC/UL	Version	Part Number	US/CA PN	Type spare	Min quantity
E1.3	3p; 4p	IEC/UL	F; W (MP)	1SDA126442R1	K31-MECH-LIFTPLATES		1

¹ Only supplied with the circuit-breaker



High or low terminal covers - HTC/LTC

Size	Type	3 Poles		4 Poles	
		Part Number	US / CA PN	Part Number	US / CA PN
E1.3	HTC high terminal covers E1.3 2pcs	1SDA126443R1	K31-MECH-HTC	1SDA126444R1	K31-MECH-HTC-4
E1.3	LTC low terminal covers E1.3 2pcs	1SDA126445R1	K31-MECH-LTC	1SDA126446R1	K31-MECH-LTC-4



Separators / Phase Barriers - PB (1)

Size	Type	Part Number	US / CA PN
E1.3	PB H=100mm/3.94" 4pcs E1.3 Fixed 3P	1SDA073877R1	ZE1PBF100
E1.3	PB H=100mm/3.94" 6pcs E1.3 Fixed 4P	1SDA073878R1	ZE1PBF100-4
E1.3	PB H=200mm/7.87" 4pcs E1.3 Fixed 3P	1SDA073879R1	ZE1PBF200
E1.3	PB H=200mm/7.87" 6pcs E1.3 Fixed 4P	1SDA073880R1	ZE1PBF200-4
E1.3	PB 2pcs E1.3 Drawout 3P	1SDA076164R1	ZE1PBW
E1.3	PB 3pcs E1.3 Drawout 4P	1SDA076165R1	ZE1PBW-4
E2.3...E6.3	PB 2pcs E2.3...E6.3 Fixed 3P	1SDA076166R1	ZEBPBF
E2.3...E6.3	PB 3pcs E2.3...E6.3 Fixed 4P	1SDA076167R1	ZEBPBF-4
E2.3...E6.3	PB 2pcs E2.3...E6.3 Drawout 3P	1SDA076168R1	ZEBPBW
E2.3...E6.3	PB 3pcs E2.3...E6.3 Drawout 4P	1SDA076169R1	ZEBPBW-4

SACE Emax 3 low voltage power circuit breakers

Accessories

Interlocks

Cables for mechanical interlock [Group 1]

Size	Type	Part Number	US / CA PN
E1.3...E6.3	Type A horizontal	1SDA126447R1	K3A-MECH-CABLEHRA
E2.3..E6.3	Type B,C,D horizontal	1SDA126448R1	K3B-MECH-CABLEHRBCD
E1.3...E6.3	Type A vertical	1SDA126449R1	K3A-MECH-CABLEVRA
E2.3..E6.3	Type B,C,D vertical	1SDA126450R1	K3B-MECH-CABLEVRBCD

Note: One type of cable must be ordered for each interlock. The cable must be ordered with the fixed circuit-breaker or the cradle of a drawout circuit-breaker.

Lever for mechanical interlock of fixed circuit-breaker or cradle [Group 2]

Size	Type	3 Poles		4 Poles	
		Part Number	US / CA PN	Part Number	US / CA PN
E2.3	Lever for mechanical interlock	1SDA126451R1	K32-MECH-LEVER	1SDA126451R1	K32-MECH-LEVER
E4.3	Lever for mechanical interlock	1SDA126452R1	K34-MECH-LEVER	1SDA126452R1	K34-MECH-LEVER
E6.3	Lever for mechanical interlock	1SDA126453R1	K36-MECH-LEVER	1SDA126454R1	K36-MECH-LEVER-4

Note: The lever for the mechanical interlock is not required for E1.3

Support for mechanical interlock of fixed circuit-breaker [Group 3]

Size	Type	Part Number	US / CA PN
E1.3	Type A - floor mounted	1SDA126455R1	K31-MECH-SUP-FL-AF
E1.3	Type A - wall mounted	1SDA126456R1	K31-MECH-SUP-WALL-AF
E2.3...E6.3	Type A / B / D	1SDA126457R1	K3B-MECH-SUP-ABD
E2.3...E6.3	Type C	1SDA126458R1	K3B-MECH-SUP-C

Support for mechanical interlock of fixed part [Group 4]

Size	Type	Part Number	US / CA PN
E1.3	Type A	1SDA126459R1	K31-MECH-SUP-AW
E2.3...E6.3	Type A / B / D	1SDA126457R1	K3B-MECH-SUP-ABD
E2.3...E6.3	Type C	1SDA126458R1	K3B-MECH-SUP-C

SACE Emax 3 low voltage power circuit breakers

Accessories Connectivity

Options for Ekip Aware

Size	Type	Part Number	US / CA PN
E1.3...E6.3	No Wireless Connectivity ²	1SDA128405R1	F3A-EK-NOWIRELESS
E1.3...E6.3	Upper internal installed voltage cables ¹	1SDA127756R1	F3A-EK-UPPERMEAS
E1.3...E6.3	External installed voltage cables ¹	1SDA127757R1	F3A-EK-EXTMEAS

¹ All Ekip Aware trip units have lower voltage cables installed by default

² It means Bluetooth and NFC disabled. Only supplied with the circuit-breaker



External cartridge

Size	Type	Part Number	US / CA PN
E1.3...E6.3	Ekip Cartridge	1SDA127787R1	K3A-EK-CARTRIDGE4



Power Supply

Size	Type	Part Number	US / CA PN
E1.3...E6.3	Ekip Supply Lite 24-240VAC/DC ³	1SDA126470R1	K3A-EK-SUPPLYLITE
E1.3...E6.3	Ekip Supply Evo Modbus TCP ⁴	1SDA126472R1	K3A-COM-EVOMODTCP
E1.3...E6.3	Ekip Busbars Supply ^{1,2}	1SDA126493R1	F3A-EK-BUSBARSUPPLY

¹ Voltage measurement cables always present

² Only supplied with the circuit-breaker

³ do not include Ekip RTC and Ekip AUP in the kit; therefore, if required, they must be ordered separately.

⁴ Provided with Ekip RTC and Ekip AUP.



Communication modules

Size	Type	Part Number	US / CA PN
E1.3...E6.3	Ekip Com Modbus RTU ²	1SDA126471R1	K3A-COM-MODRTU
E1.3...E6.3	Ekip Com Profibus ²	1SDA126473R1	K3A-COM-PROFIBUS
E1.3...E6.3	Ekip Com Profinet ^{1,3}	1SDA126474R1	K3A-COM-PROFINET
E1.3...E6.3	Ekip Com EtherNet/IP ^{1,3}	1SDA126475R1	K3A-COM-ETHERNETIP
E1.3...E6.3	Ekip Com IEC61850 ^{1,3}	1SDA126476R1	K3A-COM-61850

¹ Ekip Supply Evo Modbus TCP mandatory

² provided with Ekip RTC and Ekip AUP

³ do not include Ekip RTC and Ekip AUP in the kit; therefore, if required, they must be ordered separately



Signalling modules

Size	Type	Part Number	US / CA PN
E1.3...E6.3	Ekip Signalling 2K-1	1SDA126481R1	K3A-EK-2K1
E1.3...E6.3	Ekip Signalling 2K-2	1SDA126482R1	K3A-EK-2K2
E2.3...E6.3	Ekip Signalling 4K ¹	1SDA126484R1	K3B-EK-4K
E1.3...E6.3	Ekip Signalling 10K Link ²	1SDA126485R1	K3A-EK-10KLINK
E1.3...E6.3	Ekip Signalling Modbus TCP ²	1SDA082485R1	ZEASIGMBTCP

¹ Ekip 4K is not available for the E1.3. It is an alternative to the AUX 6Q (6 Form C) auxiliary contacts unit on other frames

² Only loose

SACE Emax 3 low voltage power circuit breakers

Accessories
Connectivity



Temperature modules

Size	Type	Part Number	US / CA PN
E1.3...E6.3	Ekip Temperature 4T-1 ¹	1SDA126487R1	K3A-EK-TEMP4T1
E1.3...E6.3	Ekip Temperature 4T-2 ¹	1SDA126488R1	K3A-EK-TEMP4T2
E1.3...E6.3	External Probe PT1000 3mt ²	1SDA085695R1	ZEA3TPR
E1.3...E6.3	T-sense Ambient ³	1SDA126489R1	K3A-EK-TSENSEAMBIENT
E1.3...E6.3	T-sense Busbars ³	1SDA126490R1	K3A-EK-TSENSEBUSBAR

¹ External probe PT100/PT1000 not supplied

² For busbar applications only. The Part Number includes one loose single probe.

³ Auxiliary supply is needed (Ekip Supply Lite or Ekip Supply Evo Modbus TCP)



Protection modules

Size	Type	Part Number	US / CA PN
E1.3...E6.3	Ekip RELT	1SDA126483R1	K3A-EK-RELT
E1.3...E6.3	Ekip Arc-Flash 6F-1	1SDA126491R1	K3A-EK-ARCFLASH6F1
E1.3...E6.3	Ekip Arc-Flash 6F-2	1SDA128420R1	K3A-EK-ARCFLASH6F2
E1.3...E6.3	Light-Sense Detector ¹	1SDA126492R1	K3A-EK-ARCFLASHLIGHT
E1.3...E6.3	Light&Pressure-Sense Detector ¹	1SDA128423R1	K3A-EK-ARCFLASHLHP

¹ Only loose



Synchrocheck module

Size	Type	Part Number	US / CA PN
E1.3...E6.3	Ekip Synchrocheck	1SDA126494R1	K3A-EK-SYNC

Cybersecure modules compatible with IEC 622443 Emax 3 ¹

Size	Type	Part Number	US / CA PN
E1.3...E6.3	Ekip Supply Evo Modbus TCP Secure	1SDA128409R1	K3A-COM-EVOMODTCP-S
E1.3...E6.3	Ekip Com Modbus RTU Secure	1SDA128408R1	K3A-COM-MODRTU-S
E1.3...E6.3	Ekip Com Profibus Secure	1SDA128410R1	K3A-COM-PROFIBUS-S
E1.3...E6.3	Ekip Com Profinet Secure	1SDA128411R1	K3A-COM-PROFINET-S
E1.3...E6.3	Ekip Com EtherNet/IP™ Secure	1SDA128412R1	K3A-COM-ETHERNETIP-S
E1.3...E6.3	Ekip Com IEC61850 Secure	1SDA128413R1	K3A-COM-61850-S
E1.3...E6.3	Ekip Signalling 2K-1 Secure	1SDA128415R1	K3A-EK-2K1-S
E1.3...E6.3	Ekip Signalling 2K-2 Secure	1SDA128416R1	K3A-EK-2K2-S
E1.3...E6.3	Ekip RELT Secure	1SDA128417R1	K3A-EK-RELT-S
E1.3...E6.3	Ekip Synchrocheck Secure	1SDA128424R1	K3A-EK-SYNC-S
E1.3...E6.3	Ekip Temperature 4T-1 Secure	1SDA128418R1	K3A-EK-TEMP4T1-S
E1.3...E6.3	Ekip Temperature 4T-2 Secure	1SDA128419R1	K3A-EK-TEMP4T2-S
E1.3...E6.3	Ekip Arc-Flash 6F-1 Secure	1SDA128421R1	K3A-EK-ARCFLASH6F1-S
E1.3...E6.3	Ekip Arc-Flash 6F-2 Secure	1SDA128422R1	K3A-EK-ARCFLASH6F2-S
E1.3...E6.3	Ekip Signalling 10K Link Secure	1SDA133779R1	K3A-EK-10KLINK-S

¹ To comply with IEC 62443-4-2, both cybersecure modules and cybersecure circuit-breaker (1SDA126529R1) must be purchased together. Cybersecure modules can be purchased with the circuit breaker or aftersales as standalone.

SACE Emax 3 low voltage power circuit breakers

Accessories

Displaying

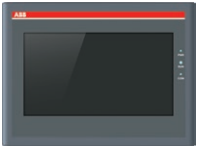

Displaying system

Size	Type	Part Number	US / CA PN
E1.3...E6.3	Lite Panel Pro	1SDA123321R1	ABBLITEPANELPRO



SACE Emax 3 low voltage power circuit breakers

Accessories
Digital upgrades

Protection upgrades

Size	Type	Supplied with the breaker		ABB Marketplace order	
		Part Number	US / CA PN	Part Number	US / CA PN
E1.3...E6.3	Protection S ¹	1SDA126499R1	K3A-SW-SHORTTIME	1SDA126588R1	K3A-SWMP-SHORTTIME
E1.3...E6.3	Protection G ¹	1SDA126507R1	K3A-SW-GROUND	1SDA126596R1	K3A-SWMP-GROUND
E1.3...E6.3	L protection OFF setting	1SDA126561R1	F3A-SW-LOFF	1SDA126643R1	K3A-SWMP-LOFF
E1.3...E4.3	RC protection	1SDA126562R1	F3A-SW-RC	1SDA126644R1	K3A-SWMP-RC
E1.3...E6.3	Advanced MDGF	1SDA126512R1	F3A-SW-MDGF	1SDA133352R1	K3A-SWMP-MDGF
E1.3...E6.3	Advanced Current Protections	1SDA126513R1	F3A-SW-ADCURR	1SDA126605R1	K3A-SWMP-ADCURR
E1.3...E6.3	Voltage Protection	1SDA126514R1	F3A-SW-VOLT	1SDA126606R1	K3A-SWMP-VOLT
E1.3...E6.3	Frequency Protection	1SDA126515R1	F3A-SW-FREQ	1SDA126607R1	K3A-SWMP-FREQ
E1.3...E6.3	Power Protection	1SDA126516R1	F3A-SW-POWER	1SDA126608R1	K3A-SWMP-POWER
E1.3...E6.3	Directional protection	1SDA126517R1	F3A-SW-DIR	1SDA126609R1	K3A-SWMP-DIR
E1.3...E6.3	Advanced Voltage Protection	1SDA126518R1	F3A-SW-ADVOLT	1SDA126610R1	K3A-SWMP-ADVOLT
E1.3...E6.3	Dual Setting	1SDA126524R1	F3A-SW-DUAL	1SDA126616R1	K3A-SWMP-DUAL
E1.3...E6.3	Triple Setting	1SDA126525R1	F3A-SW-TRIPLE	1SDA126617R1	K3A-SWMP-TRIPLE

¹ Only loose from MarketPlace

Power quality upgrades

Size	Type	Supplied with the breaker		ABB Marketplace order	
		Part Number	US / CA PN	Part Number	US / CA PN
E1.3...E6.3	Measuring	1SDA126519R1	F3A-SW-MEASURING	1SDA126611R1	K3A-SWMP-MEASURING
E1.3...E6.3	Network Analyzer	1SDA126520R1	F3A-SW-NETWORK	1SDA126612R1	K3A-SWMP-NETWORK
E1.3...E6.3	Datalogger Pro ¹	1SDA126522R1	F3A-SW-DATALOGPRO	1SDA126614R1	K3A-SWMP-DATALOGPRO

¹ SD card must be purchased separately

Digital tools upgrade

Size	Type	Supplied with the breaker		ABB Marketplace order	
		Part Number	US / CA PN	Part Number	US / CA PN
E1.3...E6.3	Remote Control ¹	1SDA126526R1	F3A-SW-REMOTEOP	1SDA126618R1	K3A-SWMP-REMOTEOP
E1.3...E6.3	Test Area PRO ²	1SDA126528R1	F3A-SW-TESTAREA	1SDA126620R1	K3A-SWMP-TESTAREA

¹ Only for EPiC mobile. It allows to open and close circuit breaker via BLE through EPiC mobile app.

² Only for Ekip Connect

SACE Emax 3 low voltage power circuit breakers

Accessories

Digital upgrades

Power management upgrades

Size	Type	Supplied with the breaker		ABB Marketplace order	
		Part Number	US / CA PN	Part Number	US / CA PN
E1.3...E6.3	Power Controller	1SDA126523R1	F3A-SW-PWRCONTROL	1SDA126615R1	K3A-SWMP-PWRCONTROL
E1.3...E6.3	Adaptive Load Shedding	1SDA126530R1	F3A-SW-ADPLOAD	1SDA126621R1	K3A-SWMP-ADPLOAD
E1.3...E6.3	Custom logic	1SDA126527R1	F3A-SW-CUSTLOGICS	1SDA126619R1	K3A-SWMP-CUSTLOGICS

Communication upgrades

Size	Type	Supplied with the breaker		ABB Marketplace order	
		Part Number	US / CA PN	Part Number	US / CA PN
E1.3...E6.3	Com Link ¹	1SDA126479R1	F3A-SW-COMLINK	1SDA126646R1	K3A-SWMP-COMLINK
E1.3...E6.3	Modbus TCP Security Protocol ^{1,2}	1SDA126478R1	K3A-COM-MODTCP-S		

¹ Ekip Supply Evo Modbus TCP mandatory

² Only supplied with the circuit breaker. It is according to Modbus Security Protocol Specification

DIGITAL RATING PLUG UPGRADE

Size	Type	Supplied with the breaker		ABB Marketplace order	
		Part Number	US / CA PN	Part Number	US / CA PN
E1.3...E6.3	Flexible Digital Rating Plug ¹	1SDA126623R1	-	1SDA126624R1	K3A-SWMP-RPFLEX
E1.3...E6.3	Rating Plug Card ²	1SDA128425R1	K3A-EK-RPCARD	-	-

¹ When the Digital Rating Plug is changed, Rating Plug card must be purchased

² The Rating Plug card includes a set of stickers with different In values, which can be applied to the circuit breaker when replacing the Digital Rating Plug.

SACE Emax 3 low voltage power circuit breakers

Accessories

Power Connections

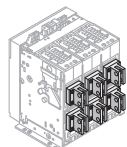

Rear orientable terminal - HR VR

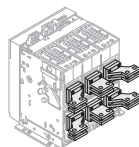

Horizontal rear terminal - SHR

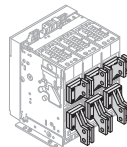

Vertical rear spread terminal - SVR

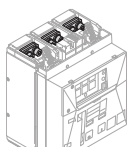

Front terminal - F

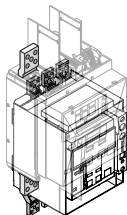

Extended front terminal - EF

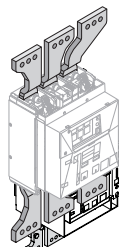

Front spread terminal - ES

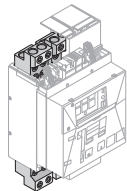

Terminal for cable FcCuAl 4x240mm² - Fc CuAl

Kit for terminals - installed on fixed circuit breaker

Size	Version	Max amperage	Type	3 Poles		4 Poles	
				Global PN	US / CA PN	Global PN	US / CA PN
E1.3	F	1200	Kit EF Upper ¹	1SDA073963R1	Fact. inst. only	1SDA073964R1	Fact. inst. only
E1.3	F	1200	Kit EF Lower ¹	1SDA073965R1	Fact. inst. only	1SDA073966R1	Fact. inst. only
E1.3	F	1200	Kit ES Upper ¹	1SDA073975R1	Fact. inst. only	1SDA073976R1	Fact. inst. only
E1.3	F	1200	Kit ES Lower ¹	1SDA073977R1	Fact. inst. only	1SDA073978R1	Fact. inst. only
E1.3	F	1200	Kit HR Upper	1SDA079840R1	Fact. inst. only	1SDA079841R1	Fact. inst. only
E1.3	F	1200	Kit HR Lower	1SDA079842R1	Fact. inst. only	1SDA079843R1	Fact. inst. only
E1.3	F	1200	Kit VR Upper	1SDA079836R1	Fact. inst. only	1SDA079837R1	Fact. inst. only
E1.3	F	1200	Kit VR Lower	1SDA079838R1	Fact. inst. only	1SDA079839R1	Fact. inst. only
E1.3	F	1200	Kit FcCuAl 4x500kcmil/240mm ² Upper ¹	1SDA073997R1	Fact. inst. only	1SDA073998R1	Fact. inst. only
E1.3	F	1200	Kit FcCuAl 4x500kcmil/240mm ² Lower ¹	1SDA073999R1	Fact. inst. only	1SDA074000R1	Fact. inst. only
E2.3	F	2000	Kit F Upper ¹	1SDA074118R1	Fact. inst. only	1SDA074119R1	Fact. inst. only
E2.3	F	2000	Kit F Lower ¹	1SDA074120R1	Fact. inst. only	1SDA074121R1	Fact. inst. only
E2.3	F	2000	Kit VR Upper	1SDA079852R1	Fact. inst. only	1SDA079853R1	Fact. inst. only
E2.3	F	2000	Kit VR Lower	1SDA079854R1	Fact. inst. only	1SDA079855R1	Fact. inst. only
E4.3	F	3200	Kit F Upper ¹	1SDA074126R1	Fact. inst. only	1SDA074127R1	Fact. inst. only
E4.3	F	3200	Kit F Lower ¹	1SDA074128R1	Fact. inst. only	1SDA074129R1	Fact. inst. only
E4.3	F	2500	Kit VR Upper	1SDA079862R1	Fact. inst. only	1SDA079863R1	Fact. inst. only
E4.3	F	2500	Kit VR Lower	1SDA079864R1	Fact. inst. only	1SDA079865R1	Fact. inst. only
E6.3	F	6000	Kit F Upper ¹	1SDA074134R1	Fact. inst. only	1SDA074135R1	Fact. inst. only
E6.3	F	6000	Kit F Lower ¹	1SDA074137R1	Fact. inst. only	1SDA074138R1	Fact. inst. only
E6.3	F	5000	Kit VR Upper	1SDA079891R1	Fact. inst. only	1SDA079892R1	Fact. inst. only
E6.3	F	5000	Kit VR Lower	1SDA079893R1	Fact. inst. only	1SDA079894R1	Fact. inst. only
E6.3/f	F	6000	Kit F Upper ¹	-	-	1SDA074136R1	Fact. inst. only
E6.3/f	F	6000	Kit F Lower ¹	-	-	1SDA074138R1	Fact. inst. only

¹ Not UL listed

SACE Emax 3 low voltage power circuit breakers

Accessories

Power Connections

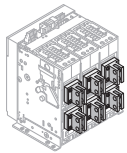

Rear orientable terminal - HR VR

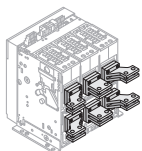

Horizontal rear terminal - SHR

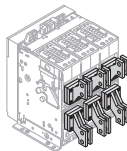

Vertical rear spread terminal - SVR

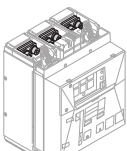

Front terminal - F

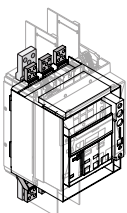

Extended front terminal - EF

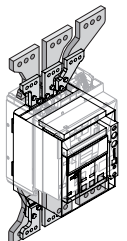

Front spread terminal - ES

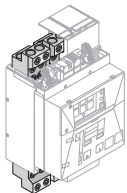

Terminal for cable FcCuAl 4x240mm² - Fc CuAl

Kit for terminals - installed on cradle

Size	Version	Max amperage	Type	3 Poles		4 Poles	
				Global PN	US / CA PN	Global PN	US / CA PN
E1.3	W	1200	Kit EF Upper ²	1SDA073939R1	Fact. inst. only	1SDA073940R1	Fact. inst. only
E1.3	W	1200	Kit EF Lower ²	1SDA073941R1	Fact. inst. only	1SDA073942R1	Fact. inst. only
E1.3	W	1200	Kit ES Upper ^{1,2}	1SDA073951R1	Fact. inst. only	1SDA073952R1	Fact. inst. only
E1.3	W	1200	Kit ES Lower ^{1,2}	1SDA073953R1	Fact. inst. only	1SDA073954R1	Fact. inst. only
E1.3	W	1200	Kit VR Upper	1SDA079830R1	Fact. inst. only	1SDA079831R1	Fact. inst. only
E1.3	W	1200	Kit VR Lower	1SDA079832R1	Fact. inst. only	1SDA079833R1	Fact. inst. only
E1.3	W	1200	Kit FcCuAl 4x 500kcmil/240mm ² Lower ²	1SDA073991R1	Fact. inst. only	1SDA073993R1	Fact. inst. only
E1.3	W	1200	Kit FcCuAl 4x 500kcmil/240mm ² Lower ²	1SDA073992R1	Fact. inst. only	1SDA073994R1	Fact. inst. only
E3.3	W	2000	Kit F Upper ²	1SDA074090R1	Fact. inst. only	1SDA074091R1	Fact. inst. only
E3.3	W	2000	Kit F Lower ²	1SDA074092R1	Fact. inst. only	1SDA074093R1	Fact. inst. only
E3.3	W	2000	Kit VR Upper	1SDA079846R1	Fact. inst. only	1SDA079847R1	Fact. inst. only
E3.3	W	2000	Kit VR Lower	1SDA079848R1	Fact. inst. only	1SDA079849R1	Fact. inst. only
E4.3	W	3200	Kit F Upper ²	1SDA074098R1	Fact. inst. only	1SDA074099R1	Fact. inst. only
E4.3	W	3200	Kit F Lower ²	1SDA074100R1	Fact. inst. only	1SDA074101R1	Fact. inst. only
E4.3	W	2500	Kit VR Upper	1SDA079856R1	Fact. inst. only	1SDA079857R1	Fact. inst. only
E4.3	W	2500	Kit VR Lower	1SDA079858R1	Fact. inst. only	1SDA079859R1	Fact. inst. only
E6.3	W	6000	Kit F Upper ²	1SDA074106R1	Fact. inst. only	1SDA074107R1	Fact. inst. only
E6.3	W	6000	Kit F Lower ²	1SDA074109R1	Fact. inst. only	1SDA074110R1	Fact. inst. only
E6.3	W	5000	Kit VR Upper	1SDA079882R1	Fact. inst. only	1SDA079883R1	Fact. inst. only
E6.3	W	5000	Kit VR Lower	1SDA079885R1	Fact. inst. only	1SDA079886R1	Fact. inst. only
E6.3/f	W	6000	Kit F Upper ²	-	-	1SDA074108R1	-
E6.3/f	W	6000	Kit F Lower ²	-	-	1SDA074111R1	-
E6.3/f	W	5000	Kit VR Upper	-	Fact. inst. only	1SDA079884R1	Fact. inst. only
E6.3/f	W	5000	Kit VR Lower	-	Fact. inst. only	1SDA079887R1	Fact. inst. only

¹ ES terminals can be ordered only if the cradle also has EF terminals.

² Not UL listed

SACE Emax 3 low voltage power circuit breakers

Accessories

Power Connections

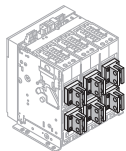

Rear orientable terminal - HR VR

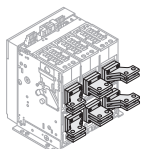

Horizontal rear terminal - SHR

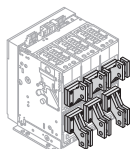

Vertical rear spread terminal - SVR

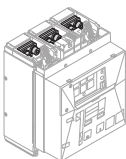

Front terminal - F

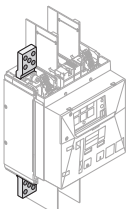

Extended front terminal - EF

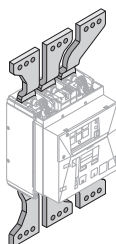

Front spread terminal - ES

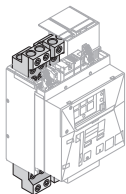

Terminal for cable FcCuAl 4x240mm² - Fc CuAl

Kit for terminals - loose supply for one side of fixed circuit breaker

Size	Version	Max amperage	Type	3 Poles		4 Poles	
				Global PN	US / CA PN	Global PN	US / CA PN
E1.3	F	1200	Kit EF ¹	1SDA073967R1	ZE1EFF	1SDA073968R1	ZE1EFF-4
E1.3	F	1200	Kit F ¹	1SDA073973R1	ZE1FF	1SDA073974R1	ZE1FF-4
E1.3	F	1200	Kit ES ¹	1SDA073979R1	ZE1ESF	1SDA073980R1	ZE1ESF-4
E1.3	F	1200	Kit Adjustable HR/VR	1SDA079844R1	ZE1HRVRF	1SDA079845R1	ZE2HRVRF-4
E1.3	F	1200	Kit FcCuAl 4x500kcmil/240mm ² ¹	1SDA074001R1	ZE1LUGF	1SDA074002R1	ZE1LUGF-4
E3.3	F	2000	Kit F Upper ¹	1SDA074122R1	ZE2FUF	1SDA074123R1	ZE2FUF-4
E3.3	F	2000	Kit F Lower ¹	1SDA074124R1	ZE2FLF	1SDA074125R1	ZE2FLF-4
E3.3	F	2000	Adjustable HR/VR	1SDA079850R1	ZE2HRVRFW	1SDA079851R1	ZE2HRVRFW-4
E4.3	F	3200	Kit F Upper ¹	1SDA074130R1	ZE4FUF	1SDA074131R1	ZE4FUF-4
E4.3	F	3200	Kit F Lower ¹	1SDA074132R1	ZE4FLF	1SDA074133R1	ZE4FLF-4
E4.3	F	2500	Kit Adjustable HR/VR	1SDA079860R1	ZE4HRVRFW25	1SDA079861R1	ZE4HRVRFW25-4
E4.3	F	3200	Kit VR	1SDA079866R1	ZE4VRFW32	1SDA079867R1	ZE4VRFW32
E6.3	F	6000	Kit F Upper ¹	1SDA074140R1	ZE6FUF	1SDA074141R1	ZE6FU-4
E6.3	F	6000	Kit F Lower ¹	1SDA074143R1	ZE6FLF	1SDA074144R1	ZE6FLF-4
E6.3	F	5000	Kit Adjustable HR/VR	1SDA079888R1	ZE6HRVRFW50	1SDA079889R1	ZE6HRVRFW50-4
E6.3	F	6000	Kit VR	1SDA079895R1	ZE6VRFW60	-	-
E6.3/f	F	6000	Kit F Upper ¹	-	-	1SDA074142R1	ZE6FUF-4F
E6.3/f	F	6000	Kit F Lower ¹	-	-	1SDA074145R1	ZE6FLF-4F
E6.3/f	F	5000	Kit Adjustable HR/VR	-	-	1SDA079890R1	ZE6HRVRFW50-4F

¹ Not UL listed

SACE Emax 3 low voltage power circuit breakers

Accessories

Power Connections

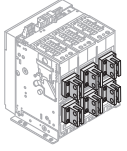

Rear orientable terminal - HR VR

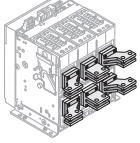

Horizontal rear terminal - SHR

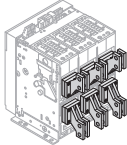

Vertical rear spread terminal - SVR

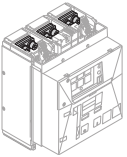

Front terminal - F

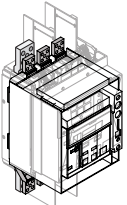

Extended front terminal - EF

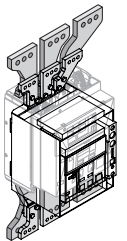

Front spread terminal - ES

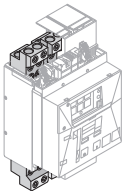

Terminal for cable FcCuAl 4x240mm² - Fc CuAl

Kit for terminals - loose supply for one side of cradle

Size	Version	Max amperage	Type	3 Poles		4 Poles	
				Global PN	US / CA PN	Global PN	US / CA PN
E1.3	W	1200	Kit EF ²	1SDA073943R1	ZE1EFW	1SDA073944R1	ZE1EFW-4
E1.3	W	1200	Kit ES ^{1,2}	1SDA073955R1	ZE1ESW	1SDA073956R1	ZE1ESW-4
E1.3	W	1200	Kit Adjustable HR/VR	1SDA079834R1	ZE1HRVRW	1SDA079835R1	ZE1HRVRW-4
E1.3	W	1200	Kit FcCuAl 4x 500kcmil/240mm ² ²	1SDA073995R1	ZE1LUGW	1SDA073996R1	ZE1LUGW-4
E3.3	W	2000	Kit F Upper ²	1SDA074094R1	ZE2FUW	1SDA074095R1	ZE2FUW-4
E3.3	W	2000	Kit F Lower ²	1SDA074096R1	ZE2FLW	1SDA074097R1	ZE2FLW-4
E3.3	W	2000	Kit Adjustable HR/VR	1SDA079850R1	ZE2HRVRFW	1SDA079851R1	ZE2HRVRFW-4
E4.3	W	3200	Kit F Upper ²	1SDA074102R1	ZE4FUW	1SDA074103R1	ZE4FUW-4
E4.3	W	3200	Kit F Lower ²	1SDA074104R1	ZE4FLW	1SDA074105R1	ZE4FLW-4
E4.3	W	2500	Kit Adjustable HR/VR	1SDA079860R1	ZE4HRVRFW25	1SDA079861R1	ZE4HRVRFW25-4
E4.3	W	3200	Kit VR	1SDA079866R1	ZE4VRFW32	1SDA079867R1	ZE4VRFW32-4
E6.3	W	6000	Kit F Upper ²	1SDA074112R1	ZE6FUW	1SDA074113R1	ZE6FUW-4
E6.3	W	6000	Kit F Lower ²	1SDA074115R1	ZE6FLW	1SDA074116R1	ZE6FLW-4
E6.3	W	5000	Kit Adjustable HR/VR	1SDA079888R1	ZE6HRVRFW50	1SDA079889R1	ZE6HRVRFW50-4
E6.3	W	6000	Kit VR	1SDA079895R1	ZE6VRFW60	1SDA079896R1	-
E6.3/f	W	6000	Kit F Upper ²	-	-	1SDA074114R1	-
E6.3/f	W	6000	Kit F Lower ²	-	-	1SDA074117R1	-
E6.3/f	W	5000	Kit Adjustable HR/VR	-	-	1SDA079890R1	ZE6HRVRFW50-4F

¹ ES terminals can be ordered only if the cradle also has EF terminals.

² Not UL listed

SACE Emax 3 low voltage power circuit breakers

Accessories
Miscellaneous

Installation manual

Size	Type	Part Number
E1.3...E6.3	Additional installation manual E1.3...E6.3 IT	1SDA126579R1
E1.3...E6.3	Additional installation manual E1.3...E6.3 EN	1SDA126580R1
E1.3...E6.3	Additional installation manual E1.3...E6.3 DE	1SDA126581R1
E1.3...E6.3	Additional installation manual E1.3...E6.3 FR	1SDA126582R1
E1.3...E6.3	Additional installation manual E1.3...E6.3 ES	1SDA126583R1
E1.3...E6.3	Additional installation manual E1.3...E6.3 CN	1SDA133734R1

Lite test report

Size	Type	Supplied with the breaker		ABB Marketplace order	
		Part Number	US / CA PN	Part Number	US / CA PN
E1.3	Test Report Lite E1.3	1SDA127783R1	F31-EK-TESTREPLITE	1SDA130141R1	K31-SWMP-TESTREPLITE
E2.3	Test Report Lite E2.3	1SDA127784R1	F32-EK-TESTREPLITE	1SDA130142R1	K32-SWMP-TESTREPLITE
E4.3	Test Report Lite E4.3	1SDA127785R1	F34-EK-TESTREPLITE	1SDA130143R1	K34-SWMP-TESTREPLITE
E6.3	Test Report Lite E6.3	1SDA127786R1	F36-EK-TESTREPLITE	1SDA130144R1	K36-SWMP-TESTREPLITE

Test report

Size	Type	Supplied with the breaker		ABB Marketplace order	
		Part Number	US / CA PN	Part Number	US / CA PN
E1.3	Test Report E1.3	1SDA126584R1	F31-EK-TESTREP	1SDA133773R1	K31-SWMP-TESTREP
E2.3	Test Report E2.3	1SDA126585R1	F32-EK-TESTREP	1SDA133774R1	K32-SWMP-TESTREP
E4.3	Test Report E4.3	1SDA126586R1	F34-EK-TESTREP	1SDA133775R1	K34-SWMP-TESTREP
E6.3	Test Report E6.3	1SDA126587R1	F36-EK-TESTREP	1SDA133776R1	K36-SWMP-TESTREP

SACE Emax 3 low voltage power circuit breakers

Accessories

Service



Note:
Warranty periods are measured from the date the circuit-breaker leaves the factory.

Extended warranty

Size	Type	Part Number (3)
E1.3...E6.3	Warranty 2 years E1.3...E6.3 ¹	1SDA129632R1
E1.3	Warranty 4 years E1.3 ²	1SDA129633R1
E2.3	Warranty 4 years E2.3 ²	1SDA129634R1
E4.3	Warranty 4 years E4.3 ²	1SDA129635R1
E6.3	Warranty 4 years E6.3 ²	1SDA129636R1
E1.3	Warranty 5 years E1.3 ²	1SDA129637R1
E2.3	Warranty 5 years E2.3 ²	1SDA129638R1
E4.3	Warranty 5 years E4.3 ²	1SDA129639R1
E6.3	Warranty 5 years E6.3 ²	1SDA129640R1

Note: The registration in the Extended Warranty online tool is mandatory

¹ Free-of-charge with site details entered

² Warranty durations:

- 4 years when site details not entered into the Extended Warranty online tool
- 5 years when site details entered into the Extended Warranty online tool.

³ Supplied only with the circuit-breaker. Specify Registration Part Number in the order to activate the warranty.

SACE Emax 2 low voltage power circuit breakers

Instructions for ordering

SACE Emax 2 configured circuit breaker/switch disconnect order code breakdown

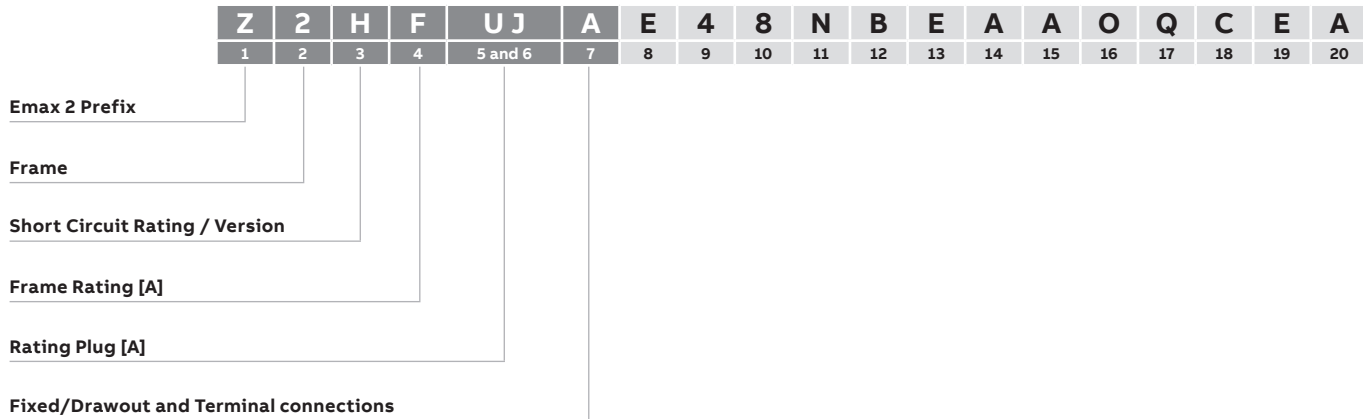

1 - Emax 2 Prefix

OEM Versions	
Z	Standard AC version
L	Triple Certification (UL/IEC/CCC)
M	ML Naval version (IEC)
9	800 - 900VAC version (IEC)
S	Marine (UL1066 SA)
ReliaGear Family	
A	Emax 2 for ReliaGear LV SWG (UL1558)
Y	Emax 2 for ReliaGear LV SB (UL891)

2 - Frame

	E1.2	E2.2	E4.2	E6.2	E6.2/f
3p	1	2	4	6	-
4p - N Left**	A	B	C	D	E
4p - N Right	F	G	H	J	K

* ReliaGear LV SWG: Only 3P version
 ** Standard

3 - Short Circuit Rating / Version

	B	C	N	S	H	V	L	X
kA @ 508V AC	42	-	50	65	85	100	-	-
UL kA @ 635V AC	42	-	50 ¹	65 ¹	85	85/100 ⁴	-	-
IEC kA @ 440V AC	42	50	66	85	100	150	-	150
IEC kA @ 690V AC	42	42	66 ²	66	85/100 ³	100	-	100

¹E1.2N = 42kA
²E1.2N = 50kA
³E2.2H and E4.2H = 85kA / E6.2H = 100kA
⁴E2.V and E4.2V = 85kA / E6.2V = 100kA

4 - Frame Rating [A]

UL	A	B	C	D	E	F	G	H	Z	J	K	L
	250	400	800	1200	1600	2000	2500	3200	3600	4000	5000	6000
IEC	M	N	P	Q	R	S	T	U	V	W	X	Y
	250	630	800	1000	1250	1600	2000	2500	3200	4000	5000	6300

SACE Emax 2 low voltage power circuit breakers

Instructions for ordering

SACE Emax 2 configured circuit breaker/switch disconnect order code breakdown

	Z	2	H	F	UJ	A	E	4	8	N	B	E	A	A	O	Q	C	E	A
	1	2	3	4	5 and 6	7	8	9	10	11	12	13	14	15	16	17	18	19	20
Emax 2 Prefix																			
Frame																			
Short Circuit Rating / Version																			
Frame Rating [A]																			
Rating Plug [A]																			
Fixed/Drawout and Terminal connections																			

5 & 6 - Rating Plug [A]

Switch	00	-	-	-	-	-	-	-	-	-	-	-	-	-	-	-	-	-	-	
UL	UA	UB	UC	UD	UE	UF	UG	UH	UJ	UK	UL	UN	UQ	UR	US	UT				
	100	200	250	400	600	800	1000	1200	1600	2000	2500	3200	3600	4000	5000	6000				
UL (I-ON)*	NA	NB	NC	ND	NE	NF	NG	NH	NJ	NK	NL	NN	NQ	NR	NS	NT				
	100	200	250	400	600	800	1000	1200	1600	2000	2500	3200	3600	4000	5000	6000				
IEC	EA	EB	EC	ED	EE	EF	EG	EH	EJ	EK	EL	EN	ER	ES	ET	-				
	100	200	250	400	630	800	1000	1250	1600	2000	2500	3200	4000	5000	6300	-				
IEC L-Off	LA	LB	LC	LD	LE	LF	LG	LH	LJ	LK	LL	LN	LR	LS	LT	-				
	100	200	250	400	630	800	1000	1250	1600	2000	2500	3200	4000	5000	6300	-				
IEC RC	RA	RB	RC	RD	RE	RF	RH	RK	RN	RR	-	-	-	-	-	-				
	100	200	250	400	630	800	1250	2000	3200	4000										

*Instantaneous protection always on (non-defeatable) - available for Ekip Touch or greater

7 - Fixed/Drawout and Terminal connections

	No lever	With Kirk Lever						
Drawout (less cradle)	A	Y						
Fixed (std. terminals)	B ¹							
Fixed (alt. terminals)	Upper Terminals							
Lower Terminals		Horiz. Rear (HR) ²	Vert. Rear (VR)	Front (F) ⁷	Ext. Front (EF) ⁷	FCCUAL Lugs ⁷	Horiz. Rear Spread (SHR) ^{6,7}	Vert. Rear Spread (SVR) ^{6,7}
	Horiz. Rear (HR) ²	C ³	D	E	F	G	-	-
	Vert. Rear (VR)	H	J ⁴	K	L	M	-	-
	Front (F) ⁷	N	P	Q ⁵	R	S	-	-
	Ext. Front (EF) ⁷	T	U	V	W	X	-	-
	FCCUAL Lugs ^{3,7}	2	3	4	5	6	-	-
	Horiz. Rear Spread (SHR) ^{6,7}	-	-	-	-	-	7	-
Vert. Rear Spread (SVR) ^{6,7}	-	-	-	-	-	-	8	

¹Standard terminals: E1=F / E2.2 - E6.2 = HR with exception of E4.2 3200 & 3600, and E6.2 6000A which are VR

²Not available for E4.2 3200, 3600A and E6.2 6000A

³Available for E1.2 only (IEC version)

⁴Not available for E4.2 3200, 3600A and E6.2 6000A

⁵Available for E2.2 - E6.2 (IEC versions)

⁶Available for E2.2 and E4.2 (IEC version)

⁷Not UL Listed

*ReliaGear LV SWG: Drawout Only

SACE Emax 2 low voltage power circuit breakers

Instructions for ordering

SACE Emax 2 configured circuit breaker/switch disconnect order code breakdown

Z	2	H	F	UJ	A	E	4	8	N	B	E	A	A	O	Q	C	E	A
1	2	3	4	5 and 6	7	8	9	10	11	12	13	14	15	16	17	18	19	20

Ekip Trip Unit

Auxiliary Power Supply (Ekip Supply) and Measuring Package

Communication Modules

8 - Ekip Trip Unit

Switch Disconnecter	0			
	Protection Functions	LI	LSI	LSIG
Ekip Trip Unit + Standard 250V Bell Alarm	DIP	A	B	C
	Touch	D	E	F
	Touch + Power Controller ¹	G	H	I
	Hi-Touch	-	J	K
	Hi-Touch + Power Controller ¹	-	L	M
	G Touch	-	-	N
	G Touch + Power Controller ¹	-	-	P
	G Hi-Touch	-	-	Q
	G Hi-Touch + Power Controller ¹	-	-	R
Ekip Trip Unit + optional 24VDC Bell Alarm	DIP	S	T	U
	Touch	V	W	X
	Touch + Power Controller ¹	Y	Z	1
	Hi-Touch	-	2	3
	Hi-Touch + Power Controller ¹	-	4	5
	G Touch	-	-	6
	G Touch + Power Controller ¹	-	-	7
	G Hi-Touch	-	-	8
	G Hi-Touch + Power Controller ¹	-	-	9

¹Ekip Power Controller requires the use of Ekip Measuring or Measuring Pro modules

SACE Emax 2 low voltage power circuit breakers

Instructions for ordering

SACE Emax 2 configured circuit breaker/switch disconnect order code breakdown

Z	2	H	F	UJ	A	E	4	8	N	B	E	A	A	O	Q	C	E	A
1	2	3	4	5 and 6	7	8	9	10	11	12	13	14	15	16	17	18	19	20

Ekip Trip Unit

Auxiliary Power Supply (Ekip Supply) and Measuring Package

Communication Modules

9 - Auxiliary Power Supply (Ekip Supply) and Measuring Package

	None	0	-
	-	Measuring Package*	1% Accuracy **
	-	1	2
24V - 48V DC Supply	3	4	5
110 - 240V AC/DC Supply	6	7	8
Top Supply	-	A	B
External Mtg Cables	-	C	D
Top Supply + 24V DC Supply	-	E	F
Top Supply + 110-240V AC/DC Supply	-	G	H
Ext. Mtg cables + 24V DC Supply	-	J	K
Ext. Mtg cables + 110-240V AC/DC Supply	-	L	M

¹For Ekip Touch only. Refer to 1% Accuracy Measuring column for Hi-Touch or greater

²Standard with Hi-Touch and G Hi-Touch

³When top supply is not specified bottom supply will be provided as default / ReliaGear default is top supply

10 - Communication Modules

None	0	-	-	-	-	-	-
RTC Ekip (24VDC)	Y						
Single	2	3	4	5	6	7	8
	Modbus RS-485	Modbus TCP/IP	Profibus	Profinet	DeviceNet	EtherNet/IP	IEC 61850
Combos	A	B	C	D	E	F	-
	RS-485 + TCP/IP	TCP/IP + Profibus	Profibus + Profinet	Profinet + DeviceNet	DeviceNet + EtherNet/IP	EtherNet/IP + IEC 61850	-
	G	H	J	K	L	-	-
	RS-485 + Profibus	TCP/IP + Profinet	Profibus + DeviceNet	Profinet + EtherNet/IP	DeviceNet + IEC 61850	-	-
	M	N	P	Q	-	-	-
	RS-485 + Profinet	TCP/IP + DeviceNet	Profibus + EtherNet/IP	Profinet + IEC 61850	-	-	-
	R	S	T	-	-	-	-
	RS-485 + DeviceNet	TCP/IP + EtherNet/IP	Profibus + IEC 61850	-	-	-	-
U	V	-	-	-	-	-	
RS-485 + EtherNet/IP	TCP/IP + IEC 61850	-	-	-	-	-	
W	-	-	-	-	-	-	
RS-485 + IEC 61850	-	-	-	-	-	-	

Note: not valid with Ekip Dip or Switch Disconnectors

SACE Emax 2 low voltage power circuit breakers

Instructions for ordering

SACE Emax 2 configured circuit breaker/switch disconnect order code breakdown

Z	2	H	F	UJ	A	E	4	8	N	B	E	A	A	O	Q	C	E	A
1	2	3	4	5 and 6	7	8	9	10	11	12	13	14	15	16	17	18	19	20

Redundant Communications and Additional Ekip Modules

Auxiliary Contacts (AUX) and Additional Signaling (4K)

Remote Reset (YR), 2nd Bell Alarm (S51/2) and Ready to Close Contacts (RTC)

Closing Coil (YC) and Redundant Closing Coil (YC2)

Opening Coil (YO)

Undervoltage Release (UVR) or Redundant Opening Coil (YO2)

11 - Redundant Communications and Additional Ekip Modules

None	0	-	-	-	-	-	-
Redundant Com.	2	3	4	5	6	7	8
	Modbus RS-485	Modbus TCP/IP	Profibus	Profinet	DeviceNet	EtherNet/IP	IEC 61850
Other Modules	A	B	C	Q	W	L	-
	Ekip Link	Synchrocheck	Signalling 2K-1	Ekip Com Hub	Signalling 3T-1	RELT Signalling 2K-3	-
Combos	D	E	F	R	X	-	-
	Redundant Com + Ekip Link	Redundant Com + Synchrocheck	Redundant Com + Signalling 2K	Redundant Com + Ekip Com Hub	Redundant Com + Signalling 3T-1	-	-
	G	H	J	S	Y	-	-
	Ekip Link + Synchrocheck	Synchrocheck + Signalling 2K	Signalling 2K-1 + Signalling 2K-2	Ekip Link + Ekip Com Hub	Ekip Link + Signalling 3T-1	-	-
	K	V	Z	1	M	-	-
	Ekip Link + Synchrocheck + Signalling 2K	Ekip Com Hub + Signalling 3T-1	Synchrocheck + Signalling 3T-1	Signalling 2K-1 + Signalling 3T-1	RELT-Ekip Signalling 2K3 + Ekip Link	-	-
N	T	U	9	P	-	-	
Ekip Link + Signalling 2K-1	Synchrocheck + Ekip Com Hub	Signalling 2K-1 + Ekip Com Hub	Ekip Com Hub + Signalling 2K + Signalling 3T-1	RELT-Ekip Signalling 2K3 + Redundant Com	-	-	

Note 1: Communication, Synchrocheck, Ekip 2K, Ekip 3T, and Ekip Link are not compatible with Switch Disconnectors

Note 2: Ekip Touch or greater trip unit is required for Communication, Ekip 2K, Ekip 3T, and Synchrocheck modules

Note 3: Redundant Com will match communication module selected in digit 10

12 - Auxiliary Contacts (AUX) and Additional Signaling (4K)

None	0	-	4 AUX (4Q) 400V ³	4 AUX (4Q) 24V	4 AUX (2Q+2Q) 24 & 400V
	-	-	A	B	C
	-	-	-	-	-
6 AUX (6Q) 400V ¹	D	E	F	G	
6 AUX (6Q) 24V ¹	H	J	K	L	
6 AUX (3Q+3Q) 400 & 24V ¹	M	N	B	Q	
4K Signaling ^{1,2}	-	R	S	T	

¹Not compatible with E1.2

²Not compatible with Ekip Dip or Switch disconnectors

³Provided as standard for all circuit breakers

Note: Options O, D, H and M are for use with switch disconnectors only

SACE Emax 2 low voltage power circuit breakers

Instructions for ordering

SACE Emax 2 configured circuit breaker/switch disconnect order code breakdown

Z	2	H	F	UJ	A	E	4	8	N	B	E	A	A	O	Q	C	E	A
1	2	3	4	5 and 6	7	8	9	10	11	12	13	14	15	16	17	18	19	20

Redundant Communications and Additional Ekip Modules

Auxiliary Contacts (AUX) and Additional Signaling (4K)

Remote Reset (YR), 2nd Bell Alarm (S51/2) and Ready to Close Contacts (RTC)

Closing Coil (YC) and Redundant Closing Coil (YC2)

Opening Coil (YO)

Undervoltage Release (UVR) or Redundant Opening Coil (YO2)

13 - Remote Reset (YR), 2nd Bell Alarm (S51/2) and Ready to Close Contacts (RTC)

None	0					
	-	YR 24V AC/DC	YR 110V AC/DC	YR 220V AC/DC	S51/2 250V ¹	S51/2 24V DC ¹
	-	A	B	C	P	Q
RTC 24VDC	D	E	F	G	R	S
RTC 250V AC/DC	H	J	K	L	T	U
Disable Bluetooth + Sealable Cover ²	M	N	V	W	X	Y
Disable Bluetooth + Sealable Cover ² + RTC 24VDC	Z	1	2	3	4	5
Disable Bluetooth + Sealable Cover ² + RTC 250V	6	7	8	9	I	O

¹Not compatible with E1.2

²Disable Bluetooth for Ekip Touch or greater trip unit

14 - Closing Coil (YC) and Redundant Closing Coil (YC2)

None	0										
	24V AC/DC	30V AC/DC	48V AC/DC	60V AC/DC	110-120V AC/DC	120-127V AC/DC	220-240V AC/DC	240-250V AC/DC	380-400V AC	415-440V AC	480-500V AC
YC	A	B	C	D	E	F	G	H	K	L	M
YC + YC2	N	P	Q	R	S	T	U	V	X	Y	Z

Note: YC2 will have the same control voltage as YC1

15 - Opening Coil (YO)

None	0										
	24V AC/DC	30V AC/DC	48V AC/DC	60V AC/DC	110-120V AC/DC	120-127V AC/DC	220-240V AC/DC	240-250V AC/DC	380-400V AC	415-440V AC	480-500V AC
YO	A	B	C	D	E	F	G	H	K	L	M

16 - Undervoltage Release (UVR) or Redundant Opening Coil (YO2)

None	0										
	24V AC/DC	30V AC/DC	48V AC/DC	60V AC/DC	110-120V AC/DC	120-127V AC/DC	220-240V AC/DC	240-250V AC/DC	380-400V AC	415-440V AC	480-500V AC
UVR	A	B	C	D	E	F	G	H	K	L	M
YO2 only	N	P	Q	R	S	T	U	V	X	Y	Z

SACE Emax 2 low voltage power circuit breakers

Instructions for ordering

SACE Emax 2 configured circuit breaker/switch disconnect order code breakdown

Z	2	H	F	UJ	A	E	4	8	N	B	E	A	A	O	Q	C	E	A
1	2	3	4	5 and 6	7	8	9	10	11	12	13	14	15	16	17	18	19	20

Spring Charging Motor (M) and Ekip Com Actuator

Push Button Locking Options

Racking Lock Options (1st lock) and Factory Test Report

2nd Racking Lock Options, Mechanical Operations Counter (MOC) and Extended Warranty's

17 - Spring Charging Motor (M) and Ekip Com Actuator

None	0					
Ekip Com Actuator	1	-	-	-	-	-
	24-30V AC/DC	48-60V AC/DC	100-130V AC/DC	220-250V AC/DC	380-415V AC	440-480V AC ¹
M with standard aux. for status indication of springs	2	3	4	5	7	8
M with 24V DC aux. contacts for status indication of springs	A	B	C	D	F	G
M with standard aux. for status indication of springs + Ekip Com Actuator	H	J	K	L	N	P
M with 24V DC aux. contacts for status indication of springs + Ekip Com Actuator	Q	R	S	T	U	V

Note: Standard aux = E1.2 = 250V / E2.2 - E6.2 = 400V

¹not compatible with E1.2

18 - Push Button Locking Options

None	0							
	Push Button Covers (PBC)				Padlock in Open Position (PLC)			
	PBC Special Key	PBC Padlock (4mm)	PBC Padlock (7mm)	PBC Padlock (8mm)	PLC (4mm)	PLC (7mm)	PLC (8mm)	
	2	3	4	5	6	7	8	
Key Lock in Open Position - Different Keys (KLC-D)	A	D	E	F	G	H	J	K
Key Lock in Open Position - Same Keys (KLC-S) ¹	B	L	M	N	P	Q	R	S
Key Lock in Open Position - Kirk Key provisions (KLA)	C	T	I	V	W	X	Y	Z

¹Standard key for Same Key option is #20005. Locks for #20006 - 20009 are available for order as loose accessories.

Note: Key lock options for Castell and Ronis/Profalux are available for order as loose accessories.

SACE Emax 2 low voltage power circuit breakers

Instructions for ordering

SACE Emax 2 configured circuit breaker/switch disconnect order code breakdown

Z	2	H	F	UJ	A	E	4	8	N	B	E	A	A	O	Q	C	E	A
1	2	3	4	5 and 6	7	8	9	10	11	12	13	14	15	16	17	18	19	20

Spring Charging Motor (M) and Ekip Com Actuator

Push Button Locking Options

Racking Lock Options (1st lock) and Factory Test Report

2nd Racking Lock Options, Mechanical Operations Counter (MOC) and Extended Warranty's

19 - Racking Lock Options (1st lock) and Factory Test Report

None	X	Keylock in racked in/out - Same Keys (KLP-S) ¹	Keylock in racked in/out - Different Keys (KLP-D) ¹	Keylock in racked in/out - Kirk/Ronis/Profulau provisions (KLP-A) ¹	Keylock in racked in/out - Castell provisions (KLP-A) ²
	-	A	B	C	D
Padlock in racked in/out position (PLP)	E	F	G	H	J
Factory Test Report	K	M	N	P	Q
PLP + Factory Test Report	R	S	T	U	V

¹Standard key for Same Key option is #20005. Locks for #20006 - 20009 are available for order as loose accessories.

²Two Castell adapters cannot be used at once, but can be used in either position with another type of lock.

20 - 2nd Racking Lock Options, Mechanical Operations Counter (MOC) and Extended Warranty's

None	X	Keylock in racked in/out - Same Keys (KLP-S) ¹	Keylock in racked in/out - Different Keys (KLP-D) ¹	Keylock in racked in/out - Kirk/Ronis/Profulau provisions (KLP-A) ¹	Keylock in racked in/out - Castell provisions (KLP-A) ²
		B	C	D	E
Mechanical Operations Counter (MOC)	A	F	G	H	J
2 Year Extended Warranty	2	N	R	U	Y
4 Year Extended Warranty	4	P	S	V	Z
5 Year Extended Warranty	5	Q	T	W	6
Additional Combinations					
MOC + 2 Year Extended Warranty	K	7	-	-	-
MOC + 4 Year Extended Warranty	L	8	-	-	-
MOC + 5 Year Extended Warranty	M	9	-	-	-

Note: for additional combinations please contact your local ABB sales person

SACE Emax 2 low voltage power circuit breakers

Instructions for ordering

SACE Emax 2 cradle (fixed part) order code breakdown

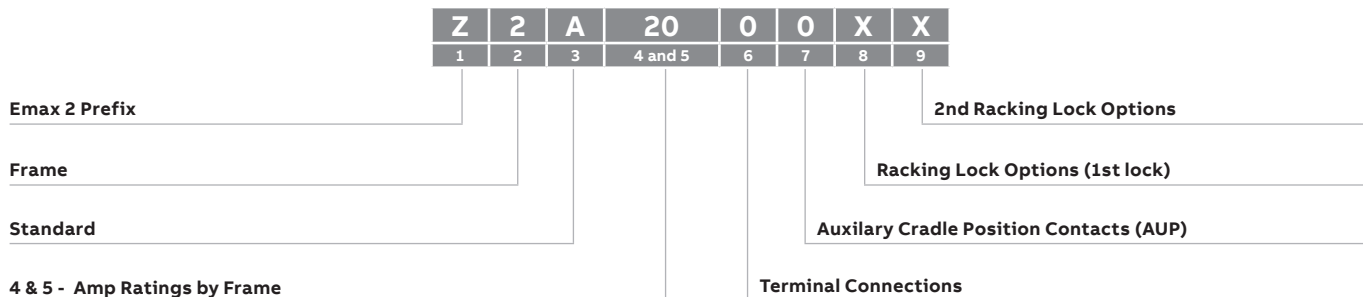

1 - Emax 2 Prefix

Z	Standard AC version
M	ML Naval version (IEC)

2 - Frame

	E1.2	E2.2	E4.2	E6.2	E6.2/fUL	
3p	1	2	4	6	- IEC	A
4p	A	B	C	D	E	C

3 - Standard

4 & 5 - Amp Ratings by Frame

UL	E1.2 1200A	E2.2 2000A	E4.2 2500A	E4.2 3200A	E6.2 5000A	E6.2 6000A	
	12	20	25	32	50	60	-
IEC	E1.2 1600A	E2.2 2000A	E4.2 2500A	E4.2 3200A	E4.2 4000A	E6.2 5000A	E6.2 6300A
	16	20	25	32	40	50	63

Note: E4.2 3200A (IEC) is compatible with N, S, and H versions for V version use E4.2 4000A

6 - Terminal Connections

Standard Terminals	A ¹							
Alternate Terminals	Upper Terminals							
Lower Terminals		Horiz. Rear (HR)²	Vert. Rear (VR)	Front (F)⁷	Ext. Front (EF)⁷	FCCUAL Lugs⁷	Horiz. Rear Spread (SHR)⁷	Vert. Rear Spread (SVR)⁷
	Horiz. Rear (HR)¹	-	D	E	F	G	-	-
	Vert. Rear (VR)	H	J ⁴	K	L	M	-	-
	Front (F)^{2,5}	N	P	Q	-	-	-	-
	Ext. Front (EF)^{3,5}	T	U	-	W	X	-	-
	FCCUAL Lugs^{3,5}	2	3	-	5	6	-	-
	Horiz. Rear Spread (SHR)^{5,6}	-	-	-	-	-	7	-
	Vert. Rear Spread (SVR)^{5,6}	-	-	-	-	-	-	8

¹Standard terminals for cradles are horizontal rear (HR) with exception of: E4.2 3200A = VR, E6.2 6000A = VR

²Not compatible with E1.2

³Available only for E1.2

⁴Not available for E4.2 3200A, E6.2 6000A as this is the standard terminals

SACE Emax 2 low voltage power circuit breakers

Instructions for ordering

SACE Emax 2 cradle (fixed part) order code breakdown

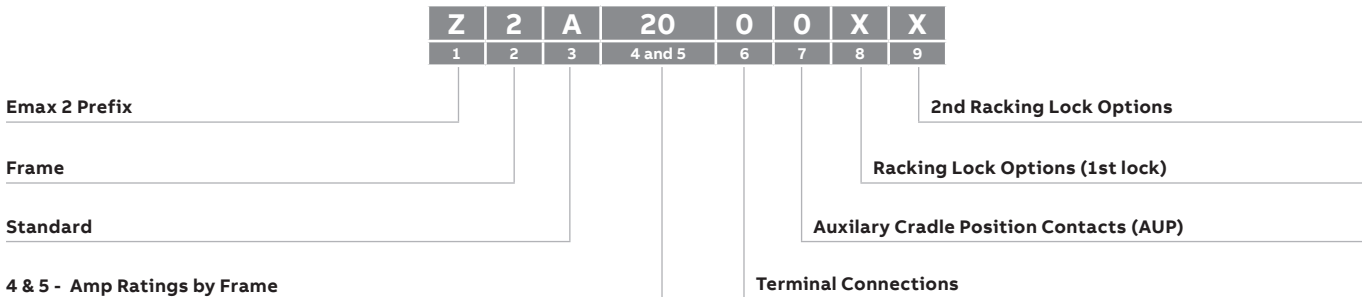

7 - Auxiliary Cradle Position Contacts (AUP)

None	0				
	6 AUP (400V AC)	6 AUP (24V DC)	5 AUP (400V AC)	5 AUP (24V DC)	-
E1.2	A	B	-	-	-
E2.2 - E6.2 Left position	-	-	C	D	-
E2.2 - E6.2 Right position	-	-	E	F	-
E2.2 - E6.2 Left & Right positions	-	-	G	H	J ¹

¹Includes one 400V set (left) and one 24VDC set (right)

8 - Racking Lock Options (1st lock)

None	X	Keylock in racked in/out - Same Keys (KLP-S) ¹	Keylock in racked in/out - Different Keys (KLP-D) ¹	Keylock in racked in/out - Kirk/Ronis/Profulaux provisions (KLP-A) ¹	Keylock in racked in/out - Castell provisions (KLP-A) ²
	-	A	B	C	D
Padlock in racked in/out position (PLP)	E	F	G	H	J
Racked out Position Lock (Supplementary)	K ³	L	M	N	P
PLP + Racked out Position Lock	Q	R	S	T	U

¹Standard key for Same Key option is #20005. Locks for #20006 - 20009 are available for order as loose accessories.

²Two Castell adapter cannot be used at once, but can be used in either position with another style of lock

³Available for E2.2-E6.2 and only if a racking lock option has been selected on the circuit breaker side

Note: Racking locks are for E1.2 For E2.2 - E6.2 they are configured within the circuit breaker

9 - 2nd Racking Lock Options

None	X	Keylock in racked in/out - Same Keys (KLP-S) ¹	Keylock in racked in/out - Different Keys (KLP-D) ¹	Keylock in racked in/out - Kirk/Ronis/Profulaux provisions (KLP-A) ¹	Keylock in racked in/out - Castell provisions (KLP-A) ²
	-	B	C	D	E

¹Standard key for Same Key option is #20005. Locks for #20006 - 20009 are available for order as loose accessories.

²Two Castell adapter cannot be used at once, but can be used in either position with another style of lock.

Note: Racking locks are for E1.2 For E2.2 - E6.2 they are configured within the circuit breaker

SACE Emax 2 low voltage power circuit breakers

Instructions for ordering

SACE Emax 2 switch disconnecter (MS/DC-E 1500VDC) order code breakdown

	P	C	H	F	O	I	O	4	8	N	B	E	A	A	O	Q	C	E	A
	1	2	3	4	5 and 6	7	8	9	10	11	12	13	14	15	16	17	18	19	20
Emax 2 Prefix																Undervoltage Release (UVR) or Redundant Opening Coil (YO2)			
Frame																Opening Coil (YO)			
Short time withstand (1s) / Version																Closing Coil (YC) and Redundant Closing Coil (YC2)			
Frame Rating [A]																Remote Reset (YR), 2nd Bell Alarm (S51/2), Ready to Close Contacts (RTC), and Disabling Bluetooth + Sealable Cover			
Rating Plug [A]																Auxiliary Contacts (AUX) and Additional Signaling (4K)			
Fixed/Drawout and Terminal connections																Redundant Communications and Additional Ekip Modules			
Ekip Trip Unit																			
Auxiliary Power Supply (Ekip Supply) and Measuring Package																			
Communication Modules																			

1 - Emax 2 Prefix

P	DC (1500VDC)
---	--------------

2 - Frame

-	E4.2
4p	C

3 - Short-time withstand (1s)/ Version

	S	V	H
UL kA @ 1500V AC	65	85	100
IEC kA @ 1500V AC	65	85	100

4 - Frame Rating [A]

UL	E	F	G	H	
	1600	2000	2500	3200	
IEC	R	S	T	U	V
	1600	2000	2500	3200	4000

5 & 6 - Rating Plug [A]

Switch	00
--------	----

7 - Fixed/Drawout and Terminal connections

	DC Insulated Network (2+2ps) Upper	DC Insulated Network (2+2ps) Lower	DC Grounded Polarity (4ps) Upper	DC Grounded Polarity (4ps) Lower
Drawout (less cradle)	A			
Fixed (std. terminals)	-	I	Z	9
				1

8 - Ekip Trip Unit

Switch Disconnecter	0
---------------------	---

9 - Auxiliary Power Supply (Ekip Supply) and Measuring Package

None	0
------	---

10 - Communication Modules

None	0
------	---

11 - Redundant Communications and Additional Ekip Modules

None	0
------	---

12 - Auxiliary Contacts (AUX) and Additional Signaling (4K)

	0	4 AUX (4Q) 400V	4 AUX (4Q) 24V	4 AUX (2Q+2Q) 24 & 400V
None	-	A	B	C
6 AUX (6Q) 400V ¹	D	E	F	G
6 AUX (6Q) 24V ¹	H	J	K	L
6 AUX (3Q+3Q) 400 & 24V ¹	M	N	B	Q

¹Not compatible with E1.2

SACE Emax 2 low voltage power circuit breakers

Instructions for ordering

SACE Emax 2 configured circuit breaker/switch disconnect order code breakdown

P	C	H	F	O	I	O	4	8	N	B	E	A	A	O	Q	C	E	A
1	2	3	4	5 and 6	7	8	9	10	11	12	13	14	15	16	17	18	19	20

Spring Charging Motor (M) and Ekip Com Actuator

Push Button Locking Options

Racking Lock Options (1st lock) and Factory Test Report

2nd Racking Lock Options, Mechanical Operations Counter (MOC) and Extended Warranty's

17 - Spring Charging Motor (M) and Ekip Com Actuator

None	0					
	24-30V AC/DC	48-60V AC/DC	100-130V AC/DC	220-250V AC/DC	380-415V AC	440-480V AC ¹
M with standard aux. for status indication of springs	2	3	4	5	7	8
M with 24V DC aux. contacts for status indication of springs	A	B	C	D	F	G

Note: Standard aux = E1.2 = 250V / E2.2 = E6.2 = 400V
¹not compatible with E1.2

18 - Push Button Locking Options

None	0						
	Push Button Covers (PBC)				Padlock in Open Position (PLC)		
	PBC Special Key	PBC Padlock (4mm)	PBC Padlock (7mm)	PBC Padlock (8mm)	PLC (4mm)	PLC (7mm)	PLC (8mm)
	2	3	4	5	6	7	8
Key Lock in Open Position - Different Keys (KLC-D)	A	D	E	F	G	H	J
Key Lock in Open Position - Same Keys (KLC-S)¹	B	L	M	N	P	Q	R
Key Lock in Open Position - Kirk Key provisions (KLA)	C	T	I	V	W	X	Y

¹Standard key for Same Key option is #20005. Locks for #20006 - 20009 are available for order as loose accessories.
 Note: Key lock options for Castell and Ronis/Profalux are available for order as loose accessories.

SACE Emax 2 low voltage power circuit breakers

Instructions for ordering

SACE Emax 2 configured circuit breaker/switch disconnect order code breakdown

P	C	H	F	O	I	O	4	8	N	B	E	A	A	O	Q	C	E	A
1	2	3	4	5 and 6	7	8	9	10	11	12	13	14	15	16	17	18	19	20

Spring Charging Motor (M) and Ekip Com Actuator

Push Button Locking Options

Racking Lock Options (1st lock) and Factory Test Report

2nd Racking Lock Options, Mechanical Operations Counter (MOC) and Extended Warranty's

19 - Racking Lock Options (1st lock) and Factory Test Report

None	X	Keylock in racked in/out - Same Keys (KLP-S) ¹	Keylock in racked in/out - Different Keys (KLP-D) ¹	Keylock in racked in/out - Kirk/Ronis/Profulaux provisions (KLP-A) ¹	Keylock in racked in/out - Castell provisions (KLP-A) ²
	-	A	B	C	D
Padlock in racked in/out position (PLP)	E	F	G	H	J

¹Standard key for Same Key option is #20005. Locks for #20006 - 20009 are available for order as loose accessories.

²Two Castell adapters cannot be used at once, but can be used in either position with another type of lock.

Note: Racking locks are for E2.2 - E6.2. For E1.2 they are configured within the cradle.

20 - 2nd Racking Lock Options, Mechanical Operations Counter (MOC) and Extended Warranty's

None	X	Keylock in racked in/out - Same Keys (KLP-S) ¹	Keylock in racked in/out - Different Keys (KLP-D) ¹	Keylock in racked in/out - Kirk/Ronis/Profulaux provisions (KLP-A) ¹	Keylock in racked in/out - Castell provisions (KLP-A) ²
	-	B	C	D	E
Mechanical Operations Counter (MOC)	A	F	G	H	J
2 Year Extended Warranty	2	N	R	U	Y
4 Year Extended Warranty	4	P	S	V	Z
5 Year Extended Warranty	5	Q	T	W	6
Additional Combinations					
MOC + 2 Year Extended Warranty	K	7	-	-	-
MOC + 4 Year Extended Warranty	L	8	-	-	-
MOC + 5 Year Extended Warranty	M	9	-	-	-

Note: for additional combinations please contact your local ABB sales person

SACE Emax 2 low voltage power circuit breakers

Instructions for ordering

SACE Emax 2 cradle MS/DC-E 1500VDC (fixed part) order code breakdown

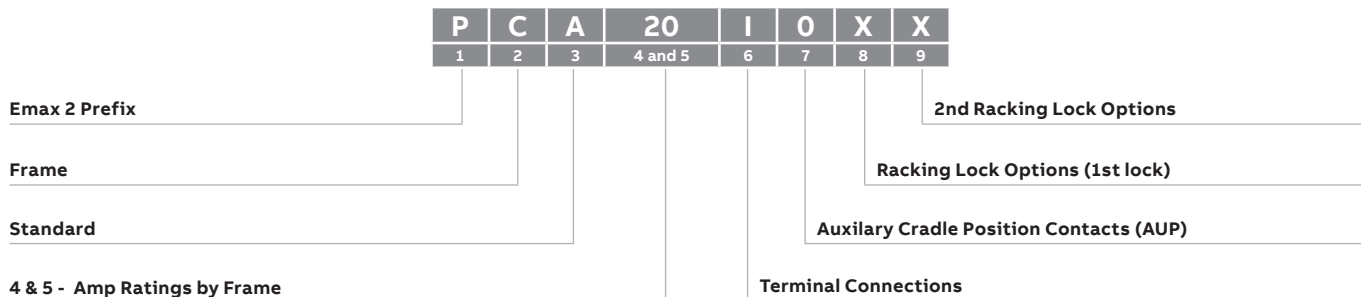

1 - Emax 2 Prefix

P	1500VDC
----------	---------

2 - Frame

	E4.2
4p	C

3 - Standard

UL	A
IEC	C

4 & 5 - Amp Ratings by Frame

UL	1600-2000A	2500A	3200A
	20	25	32
IEC	1600 -2500A	3200-4000A	
	25	40	

Note: E4.2 3200A (IEC) is compatible with N, S, and H versions for V version use E4.2 4000A

6 - Terminal Connections

DC Insulated Network (2+2ps) Upper	I
DC Insulated Network (2+2ps) Lower	Z
DC Grounded Polarity (4ps) Upper	9
DC Grounded Polarity (4ps) Lower	1

7 - Auxiliary Cradle Position Contacts (AUP)

None	0				
	6 AUP (400V AC)	6 AUP (24V DC)	5 AUP (400V AC)	5 AUP (24V DC)	-
E2.2 - E6.2 Left position	-	-	C	D	-
E2.2 - E6.2 Right position	-	-	E	F	-
E2.2 - E6.2 Left & Right positions	-	-	G	H	J ¹

¹Includes one 400V set (left) and one 24VDC set (right)

SACE Emax 2 low voltage power circuit breakers

Instructions for ordering

SACE Emax 2 cradle MS/DC-E 1500VDC (fixed part) order code breakdown

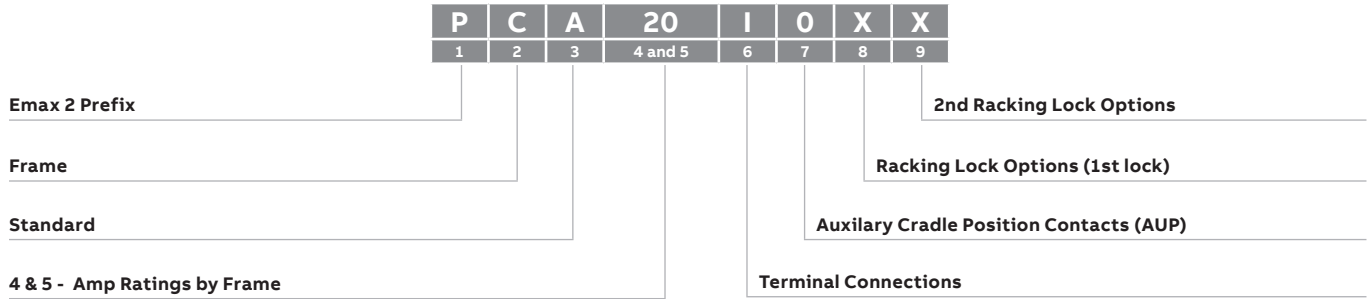

8 - Racking Lock Options (1st lock)

		Keylock in racked in/out - Same Keys (KLP-S) ¹	Keylock in racked in/out - Different Keys (KLP-D) ¹	Keylock in racked in/out - Kirk/Ronis/Profulaux provisions (KLP-A) ¹	Keylock in racked in/out - Castell provisions (KLP-A) ²
None	X				
	-	A	B	C	D
Padlock in racked in/out position (PLP)	E	F	G	H	J
Racked out Position Lock (Supplementary)	K ³	L	M	N	P
PLP + Racked out Position Lock	Q	R	S	T	U

¹Standard key for Same Key option is #20005. Locks for #20006 - 20009 are available for order as loose accessories.

²Two Castell adapter cannot be used at once, but can be used in either position with another style of lock

³Available for E2.2-E6.2 and only if a racking lock option has been selected on the circuit breaker side

Note: Racking locks are for E1.2 For E2.2 - E6.2 they are configured within the circuit breaker

9 - 2nd Racking Lock Options

		Keylock in racked in/out - Same Keys (KLP-S) ¹	Keylock in racked in/out - Different Keys (KLP-D) ¹	Keylock in racked in/out - Kirk/Ronis/Profulaux provisions (KLP-A) ¹	Keylock in racked in/out - Castell provisions (KLP-A) ²
None	X				
	-	B	C	D	E

¹Standard key for Same Key option is #20005. Locks for #20006 - 20009 are available for order as loose accessories.

²Two Castell adapter cannot be used at once, but can be used in either position with another style of lock

Note: Racking locks are for E1.2 For E2.2 - E6.2 they are configured within the circuit breaker

SACE Emax 2 low voltage power circuit breakers

Instructions for ordering

Ordering examples

Standard version Emax 2 series circuit breakers are identified by codes that can be accessorized.

Ordering examples

- **Terminal kit codes** (other than standard supply) for fixed circuit breakers or cradles.
The codes refer to 3 or 4 pieces for mounting on either the top or bottom terminals.
To convert a complete circuit breaker, 1 kit for upper terminals and 1 kit for lower terminals must be specified on the order.

Example no. 1

Emax E2.2N 3 poles fixed with vertical rear terminals (VR)	
1SDA077293R1	E2.2N-A 2000 Ekip Touch LSIG 3p F HR
1SDA079852R1	Kit VR Upper E2.2 Iu=2000 3pcs INST
1SDA079854R1	Kit VR Lower E2.2 Iu=2000 3pcs INST

Example no. 2

Emax E1.2N 4 poles fixed with upper vertical rear (VR) and lower front (F) terminals (standard supply)	
1SDA077020R1	E1.2N-A 1200 Ekip Dip LSIG 4p F F
1SDA079837R1	Kit VR Upper E1.2 Iu=1200 4pcs INST

- **Rating plug for lower rated current values.**
Rating plugs installed on the circuit breaker allow for rated current values that are lower than the rated current of the circuit breaker.

Example no. 3

Emax E2.2S 2000 3 poles fixed In=1000A	
1SDA077333R1	E2.2S-A 2000 Ekip Touch LSIG 3p F HR
1SDA074264R1	Rating Plug 1000A E1.2...E6.2 INST

- **Ordering Ekip modules.**
The Ekip Supply module enables Ekip Com, Ekip Link, Ekip 2K and Ekip Synchrocheck modules to be installed.
In addition to the Ekip Supply module, up to 3 additional modules can be installed on E2.2, E4.2 and E6.2 and up to 2 additional modules on E1.2.

Example no. 4

Emax E4.2H 3 poles fixed with modules: Ekip Supply, Ekip Com Modbus TCP, Ekip Signalling 2K, Ekip Com Modbus RCP Redundant and Ekip Signalling 4K	
1SDA077926R1	E4.2H-A 3200 Ekip Hi-Touch LSIG 3p F HR
1SDA074173R1	Ekip Supply 24-48V DC E1.2..E6.2
1SDA074151R1	Ekip Com Modbus TCP E1.2..E6.2
1SDA074158R1	Ekip Com R Modbus TCP E1.2..E6.2
1SDA074167R1	Ekip Sign. 2K-1 E1.2..E6.2
1SDA074170R1	Ekip Sign. 4K E2.2..E6.2

SACE Emax 2 low voltage power circuit breakers

Instructions for ordering

Ordering examples

Example no. 5

Emax E4.2H 3 poles fixed with modules: Ekip Supply, Ekip Com EtherNet/IP, Ekip Com Modbus RS-485 and Ekip Measuring Pro

1SDA077923R1	E4.2H-A 3200 Ekip Touch LSIG 3p F HR
1SDA074173R1	Ekip Supply 24-48V DC E1.2..E6.2
1SDA074155R1	Ekip Com EtherNet/IP E1.2..E6.2
1SDA074150R1	Ekip Com Modbus RS-485 E1.2..E6.2
1SDA074189R1	Ekip Measuring Pro E4.2

Example no. 6

Emax E1.2N 4 poles fixed with modules: Ekip Supply and Ekip Link

1SDA077020R1	E1.2N-A 1200 Ekip Dip LSIG 4p F F
1SDA074172R1	Ekip Supply 110-240V AC/DC E1.2..E6.2
1SDA074163R1	Ekip Link E1.2..E6.2

- Ordering for electrical accessories.

Example no. 7

Emax E2.2S 3 poles drawout with accessories: shunt coil, closing coil, motor and second shunt coil

1SDA077662R1	E2.2S-A 1600 Ekip Touch LSI 3p WMP
1SDA073674R1	YO E1.1..E6.2 220-240V AC/DC
1SDA073687R1	YC E1.2..E6.2 220-240V AC/DC
1SDA073725R1	M E2.2..E6.2 220-250V AC/DC
1SDA073674R1	YO E1.2..E6.2 220-240V AC/DC

- Ordering for locks.

Example no. 8

Emax E2.2N 3 poles with double key lock in racked in / test / racked out position, using different keys

1SDA077293R1	E2.2N-A 2000 Ekip Touch LSIG 3p F HR
1SDA073806R1	KLP-D BI. Racked in/out E2.2..E6.2 1st key
1SDA073812R1	KLP-D BI. Racked in/out E2.2..E6.2 2nd key

SACE Emax 2 low voltage power circuit breakers

General informations

Abbreviations used for the description of the product

Versions and terminals	
F	Fixed circuit breaker
W	Drawout circuit breaker
MP	Mobile part of drawout circuit breaker
FP	Fixed part (Cradle) of drawout circuit breaker
I_u	Rated uninterrupted current
I_n	Rated current of the rating plug
I_{cu}	Rated ultimate short-circuit breaking capacity
I_{cw}	Rated short-time withstand current
/MS	Switch disconnecter
/E	Circuit breakers for 1150V applications
/f	Four-pole circuit breakers with neutral pole at 100%
CS	Sectionalizing truck
MT	Earthing truck
MTP	Earthing switch with making capacity
HR VR	Rear orientable terminals
SHR	Horizontal rear spread terminals
SVR	Vertical rear spread terminals
F	Front terminals
FL	Flat terminals
EF	Extended front terminals
ES	Front spread terminals
Fc CuAl	Terminals for cables
Protection trip units and functions	
Ekip Dip	Protection trip unit for power distribution
Ekip Touch	Measurement and protection trip unit for power distribution
Ekip Hi Touch	Measurement and protection trip unit and network analyzer for power distribution
Ekip G Touch	Measurement and protection trip unit for generators
Ekip G Hi-Touch	Measurement and protection trip unit and protection network analyzer for generators
L	Overload protection
S	Protection against selective short circuit
I	Protection against instantaneous short circuit
G	Earth fault protection
Rc	Residual current protection
Power Controller	Load management function

SACE Emax 2 low voltage power circuit breakers

Automatic circuit breakers

Fixed version for power distribution



SACE Emax E1.2B-A/N-A • Front terminals (F)

Size	Frame Amps	Int. Rating (kA@508V)	Withstand (kA)	Type	3 Poles		4 Poles	
					Global PN	US / CA PN	Global PN	US / CA PN
E1.2B-A	800	42	42	E1.2B-A 800 Ekip Dip LI	1SDA076908R1	Z1BCUFBA000A000000XX	1SDA076988R1	ZABCUFBA000A000000XX
				E1.2B-A 800 Ekip Dip LSI	1SDA076909R1	Z1BCUFBB000A000000XX	1SDA076989R1	ZABCUFBB000A000000XX
				E1.2B-A 800 Ekip Dip LSIG	1SDA076910R1	Z1BCUFBC000A000000XX	1SDA076990R1	ZABCUFBC000A000000XX
				E1.2B-A 800 Ekip Touch LI	1SDA076911R1	Z1BCUFB000A000000XX	1SDA076991R1	ZABCUFBD000A000000XX
				E1.2B-A 800 Ekip Touch LSI	1SDA076912R1	Z1BCUFBE000A000000XX	1SDA076992R1	ZABCUFBE000A000000XX
				E1.2B-A 800 Ekip Touch LSIG	1SDA076913R1	Z1BCUFBF000A000000XX	1SDA076993R1	ZABCUFBF000A000000XX
				E1.2B-A 800 Ekip Hi-Touch LSI	1SDA076915R1	Z1BCUFBJ200A000000XX	1SDA076995R1	ZABCUFBJ200A000000XX
				E1.2B-A 800 Ekip Hi-Touch LSIG	1SDA076916R1	Z1BCUFBK200A000000XX	1SDA076996R1	ZABCUFBK200A000000XX
	1200	42	42	E1.2B-A 1200 Ekip Dip LI	1SDA076918R1	Z1BDUHBA000A000000XX	1SDA076998R1	ZABDUHBA000A000000XX
				E1.2B-A 1200 Ekip Dip LSI	1SDA076919R1	Z1BDUHBB000A000000XX	1SDA076999R1	ZABDUHBB000A000000XX
				E1.2B-A 1200 Ekip Dip LSIG	1SDA076920R1	Z1BDUHBC000A000000XX	1SDA077000R1	ZABDUHBC000A000000XX
				E1.2B-A 1200 Ekip Touch LI	1SDA076921R1	Z1BDUHBD000A000000XX	1SDA077001R1	ZABDUHBD000A000000XX
				E1.2B-A 1200 Ekip Touch LSI	1SDA076922R1	Z1BDUHBE000A000000XX	1SDA077002R1	ZABDUHBE000A000000XX
				E1.2B-A 1200 Ekip Touch LSIG	1SDA076923R1	Z1BDUHF000A000000XX	1SDA077003R1	ZABDUHBF000A000000XX
E1.2B-A 1200 Ekip Hi-Touch LSI				1SDA076925R1	Z1BDUHB200A000000XX	1SDA077005R1	ZABDUHB200A000000XX	
E1.2B-A 1200 Ekip Hi-Touch LSIG				1SDA076926R1	Z1BDUHBK200A000000XX	1SDA077006R1	ZABDUHBK200A000000XX	
E1.2N-A	800	50	50	E1.2N-A 800 Ekip Dip LI	1SDA076928R1	Z1NCUFBA000A000000XX	1SDA077008R1	ZANCUFBA000A000000XX
				E1.2N-A 800 Ekip Dip LSI	1SDA076929R1	Z1NCUFBB000A000000XX	1SDA077009R1	ZANCUFBB000A000000XX
				E1.2N-A 800 Ekip Dip LSIG	1SDA076930R1	Z1NCUFBC000A000000XX	1SDA077010R1	ZANCUFBC000A000000XX
				E1.2N-A 800 Ekip Touch LI	1SDA076931R1	Z1NCUFB000A000000XX	1SDA077011R1	ZANCUFBD000A000000XX
				E1.2N-A 800 Ekip Touch LSI	1SDA076932R1	Z1NCUFBE000A000000XX	1SDA077012R1	ZANCUFBE000A000000XX
				E1.2N-A 800 Ekip Touch LSIG	1SDA076933R1	Z1NCUFBF000A000000XX	1SDA077013R1	ZANCUFBF000A000000XX
				E1.2N-A 800 Ekip Hi-Touch LSI	1SDA076935R1	Z1NCUFBJ200A000000XX	1SDA077015R1	ZANCUFBJ200A000000XX
				E1.2N-A 800 Ekip Hi-Touch LSIG	1SDA076936R1	Z1NCUFBK200A000000XX	1SDA077016R1	ZANCUFBK200A000000XX
	1200	50	50	E1.2N-A 1200 Ekip Dip LI	1SDA076938R1	Z1NDUHBA000A000000XX	1SDA077018R1	ZANDUHBA000A000000XX
				E1.2N-A 1200 Ekip Dip LSI	1SDA076939R1	Z1NDUHBB000A000000XX	1SDA077019R1	ZANDUHBB000A000000XX
				E1.2N-A 1200 Ekip Dip LSIG	1SDA076940R1	Z1NDUHBC000A000000XX	1SDA077020R1	ZANDUHBC000A000000XX
				E1.2N-A 1200 Ekip Touch LI	1SDA076941R1	Z1NDUHBD000A000000XX	1SDA077021R1	ZANDUHBD000A000000XX
				E1.2N-A 1200 Ekip Touch LSI	1SDA076942R1	Z1NDUHBE000A000000XX	1SDA077022R1	ZANDUHBE000A000000XX
				E1.2N-A 1200 Ekip Touch LSIG	1SDA076943R1	Z1NDUHF000A000000XX	1SDA077023R1	ZANDUHF000A000000XX
E1.2N-A 1200 Ekip Hi-Touch LSI				1SDA076945R1	Z1NDUHB200A000000XX	1SDA077025R1	ZANDUHB200A000000XX	
E1.2N-A 1200 Ekip Hi-Touch LSIG				1SDA076946R1	Z1NDUHBK200A000000XX	1SDA077026R1	ZANDUHBK200A000000XX	

About wall mount is standard; for floor fixing must order: 1SDA076020R1 ZE1FFPF

SACE Emax 2 low voltage power circuit breakers

Automatic circuit breakers
Fixed version for power distribution



SACE Emax E1.2S-A • Front terminals (F)

Size	Frame Amps	Int. Rating (kA@508V)	Withstand (kA)	Type	3 Poles		4 Poles	
					Global PN	US / CA PN	Global PN	US / CA PN
E1.2S-A	250	65	50	E1.2S-A 250 Ekip Dip LI	1SDA076948R1	Z1SAUCBA000A000000XX	1SDA077028R1	ZASAUCA000A000000XX
				E1.2S-A 250 Ekip Dip LSI	1SDA076949R1	Z1SAUCBB000A000000XX	1SDA077029R1	ZASAUCCB000A000000XX
				E1.2S-A 250 Ekip Dip LSIG	1SDA076950R1	Z1SAUCBC000A000000XX	1SDA077030R1	ZASAUCCB000A000000XX
				E1.2S-A 250 Ekip Touch LI	1SDA076951R1	Z1SAUCBD000A000000XX	1SDA077031R1	ZASAUCCD000A000000XX
				E1.2S-A 250 Ekip Touch LSI	1SDA076952R1	Z1SAUCBE000A000000XX	1SDA077032R1	ZASAUCCBE000A000000XX
				E1.2S-A 250 Ekip Touch LSIG	1SDA076953R1	Z1SAUCBF000A000000XX	1SDA077033R1	ZASAUCCBF000A000000XX
				E1.2S-A 250 Ekip Hi-Touch LSI	1SDA076955R1	Z1SAUCBJ200A000000XX	1SDA077035R1	ZASAUCCBJ200A000000XX
				E1.2S-A 250 Ekip Hi-Touch LSIG	1SDA076956R1	Z1SAUCBK200A000000XX	1SDA077036R1	ZASAUCCBK200A000000XX
	400	65	50	E1.2S-A 400 Ekip Dip LI	1SDA076958R1	Z1SBUDBA000A000000XX	1SDA077038R1	ZASBUDBA000A000000XX
				E1.2S-A 400 Ekip Dip LSI	1SDA076959R1	Z1SBUDBB000A000000XX	1SDA077039R1	ZASBUDBB000A000000XX
				E1.2S-A 400 Ekip Dip LSIG	1SDA076960R1	Z1SBUDBC000A000000XX	1SDA077040R1	ZASBUDBC000A000000XX
				E1.2S-A 400 Ekip Touch LI	1SDA076961R1	Z1SBUDBD000A000000XX	1SDA077041R1	ZASBUDBD000A000000XX
				E1.2S-A 400 Ekip Touch LSI	1SDA076962R1	Z1SBUDE000A000000XX	1SDA077042R1	ZASBUDE000A000000XX
				E1.2S-A 400 Ekip Touch LSIG	1SDA076963R1	Z1SBUDBF000A000000XX	1SDA077043R1	ZASBUDBF000A000000XX
				E1.2S-A 400 Ekip Hi-Touch LSI	1SDA076965R1	Z1SBUDBJ200A000000XX	1SDA077045R1	ZASBUDBJ200A000000XX
				E1.2S-A 400 Ekip Hi-Touch LSIG	1SDA076966R1	Z1SBUDBK200A000000XX	1SDA077046R1	ZASBUDBK200A000000XX
	800	65	50	E1.2S-A 800 Ekip Dip LI	1SDA076968R1	Z1SCUFBA000A000000XX	1SDA077048R1	ZASCUFBA000A000000XX
				E1.2S-A 800 Ekip Dip LSI	1SDA076969R1	Z1SCUFB000A000000XX	1SDA077049R1	ZASCUFBB000A000000XX
				E1.2S-A 800 Ekip Dip LSIG	1SDA076970R1	Z1SCUFBC000A000000XX	1SDA077050R1	ZASCUFBC000A000000XX
				E1.2S-A 800 Ekip Touch LI	1SDA076971R1	Z1SCUFB000A000000XX	1SDA077051R1	ZASCUFBD000A000000XX
				E1.2S-A 800 Ekip Touch LSI	1SDA076972R1	Z1SCUFB000A000000XX	1SDA077052R1	ZASCUFBE000A000000XX
				E1.2S-A 800 Ekip Touch LSIG	1SDA076973R1	Z1SCUFB000A000000XX	1SDA077053R1	ZASCUFBF000A000000XX
				E1.2S-A 800 Ekip Hi-Touch LSI	1SDA076975R1	Z1SCUFBJ200A000000XX	1SDA077055R1	ZASCUFBJ200A000000XX
				E1.2S-A 800 Ekip Hi-Touch LSIG	1SDA076976R1	Z1SCUFBK200A000000XX	1SDA077056R1	ZASCUFBK200A000000XX
	1200	65	50	E1.2S-A 1200 Ekip Dip LI	1SDA076978R1	Z1SDUHBA000A000000XX	1SDA077058R1	ZASDUHBA000A000000XX
				E1.2S-A 1200 Ekip Dip LSI	1SDA076979R1	Z1SDUHBB000A000000XX	1SDA077059R1	ZASDUHBB000A000000XX
				E1.2S-A 1200 Ekip Dip LSIG	1SDA076980R1	Z1SDUHBC000A000000XX	1SDA077060R1	ZASDUHBC000A000000XX
				E1.2S-A 1200 Ekip Touch LI	1SDA076981R1	Z1SDUHBD000A000000XX	1SDA077061R1	ZASDUHBD000A000000XX
E1.2S-A 1200 Ekip Touch LSI				1SDA076982R1	Z1SDUHBE000A000000XX	1SDA077062R1	ZASDUHBE000A000000XX	
E1.2S-A 1200 Ekip Touch LSIG				1SDA076983R1	Z1SDUHB000A000000XX	1SDA077063R1	ZASDUHBF000A000000XX	
E1.2S-A 1200 Ekip Hi-Touch LSI				1SDA076985R1	Z1SDUHBJ200A000000XX	1SDA077065R1	ZASDUHBJ200A000000XX	
E1.2S-A 1200 Ekip Hi-Touch LSIG				1SDA076986R1	Z1SDUHBK200A000000XX	1SDA077066R1	ZASDUHBK200A000000XX	

About wall mount is standard; for floor fixing must order: 1SDA076020R1 ZE1FFPF

SACE Emax 2 low voltage power circuit breakers

Automatic circuit breakers

Fixed version for power distribution



SACE Emax 2 E2.2B-A/N-A • Orientable rear terminals (HR)

Size	Frame Amps	Int. Rating (kA@508V)	Withstand (kA)	Type	3 Poles		4 Poles	
					Global PN	US / CA PN	Global PN	US / CA PN
E2.2B-A	1600	42	42	E2.2B-A 1600 Ekip Dip LI	1SDA077228R1	Z2BEUJBA000A000000XX	1SDA077398R1	ZBBEUJBA000A000000XX
				E2.2B-A 1600 Ekip Dip LSI	1SDA077229R1	Z2BEUJBB000A000000XX	1SDA077399R1	ZBBEUJBB000A000000XX
				E2.2B-A 1600 Ekip Dip LSIG	1SDA077230R1	Z2BEUJBC000A000000XX	1SDA077400R1	ZBBEUJBC000A000000XX
				E2.2B-A 1600 Ekip Touch LI	1SDA077231R1	Z2BEUJBD000A000000XX	1SDA077401R1	ZBBEUJBD000A000000XX
				E2.2B-A 1600 Ekip Touch LSI	1SDA077232R1	Z2BEUJBE000A000000XX	1SDA077402R1	ZBBEUJBE000A000000XX
				E2.2B-A 1600 Ekip Touch LSIG	1SDA077233R1	Z2BEUJBF000A000000XX	1SDA077403R1	ZBBEUJBF000A000000XX
				E2.2B-A 1600 Ekip Hi-Touch LSI	1SDA077235R1	Z2BEUJBJ200A000000XX	1SDA077405R1	ZBBEUJBJ200A000000XX
				E2.2B-A 1600 Ekip Hi-Touch LSIG	1SDA077236R1	Z2BEUJBK200A000000XX	1SDA077406R1	ZBBEUJBK200A000000XX
E2.2N-A	1600	50	50	E2.2N-A 1600 Ekip Dip LI	1SDA077278R1	Z2NEUJBA000A000000XX	1SDA077448R1	ZBNEUJBA000A000000XX
				E2.2N-A 1600 Ekip Dip LSI	1SDA077279R1	Z2NEUJBB000A000000XX	1SDA077449R1	ZBNEUJBB000A000000XX
				E2.2N-A 1600 Ekip Dip LSIG	1SDA077280R1	Z2NEUJBC000A000000XX	1SDA077450R1	ZBNEUJBC000A000000XX
				E2.2N-A 1600 Ekip Touch LI	1SDA077281R1	Z2NEUJBD000A000000XX	1SDA077451R1	ZBNEUJBD000A000000XX
				E2.2N-A 1600 Ekip Touch LSI	1SDA077282R1	Z2NEUJBE000A000000XX	1SDA077452R1	ZBNEUJBE000A000000XX
				E2.2N-A 1600 Ekip Touch LSIG	1SDA077283R1	Z2NEUJBF000A000000XX	1SDA077453R1	ZBNEUJBF000A000000XX
				E2.2N-A 1600 Ekip Hi-Touch LSI	1SDA077285R1	Z2NEUJBJ200A000000XX	1SDA077455R1	ZBNEUJBJ200A000000XX
				E2.2N-A 1600 Ekip Hi-Touch LSIG	1SDA077286R1	Z2NEUJBK200A000000XX	1SDA077456R1	ZBNEUJBK200A000000XX
	2000	50	50	E2.2N-A 2000 Ekip Dip LI	1SDA077288R1	Z2NFUKBA000A000000XX	1SDA077458R1	ZBNFUKBA000A000000XX
				E2.2N-A 2000 Ekip Dip LSI	1SDA077289R1	Z2NFUKBB000A000000XX	1SDA077459R1	ZBNFUKBB000A000000XX
				E2.2N-A 2000 Ekip Dip LSIG	1SDA077290R1	Z2NFUKBC000A000000XX	1SDA077460R1	ZBNFUKBC000A000000XX
				E2.2N-A 2000 Ekip Touch LI	1SDA077291R1	Z2NFUKBD000A000000XX	1SDA077461R1	ZBNFUKBD000A000000XX
				E2.2N-A 2000 Ekip Touch LSI	1SDA077292R1	Z2NFUKBE000A000000XX	1SDA077462R1	ZBNFUKBE000A000000XX
				E2.2N-A 2000 Ekip Touch LSIG	1SDA077293R1	Z2NFUKBF000A000000XX	1SDA077463R1	ZBNFUKBF000A000000XX
				E2.2N-A 2000 Ekip Hi-Touch LSI	1SDA077295R1	Z2NFUKBJ200A000000XX	1SDA077465R1	ZBNFUKBJ200A000000XX
				E2.2N-A 2000 Ekip Hi-Touch LSIG	1SDA077296R1	Z2NFUKBK200A000000XX	1SDA077466R1	ZBNFUKBK200A000000XX

SACE Emax 2 low voltage power circuit breakers

Automatic circuit breakers

Fixed version for power distribution



SACE Emax 2 E2.2S-A • Orientable rear terminals (HR)

Size	Frame Amps	Int. Rating (kA@508V)	Withstand (kA)	Type	3 Poles		4 Poles	
					Global PN	US / CA PN	Global PN	US / CA PN
E2.2S-A	800	65	65	E2.2S-A 800 Ekip Dip LI	1SDA077298R1	Z2SCUFBA000A000000XX	1SDA077468R1	ZBSCUFBA000A000000XX
				E2.2S-A 800 Ekip Dip LSI	1SDA077299R1	Z2SCUFBB000A000000XX	1SDA077469R1	ZBSCUFBB000A000000XX
				E2.2S-A 800 Ekip Dip LSIG	1SDA077300R1	Z2SCUFBC000A000000XX	1SDA077470R1	ZBSCUFBC000A000000XX
				E2.2S-A 800 Ekip Touch LI	1SDA077301R1	Z2SCUFBD000A000000XX	1SDA077471R1	ZBSCUFBD000A000000XX
				E2.2S-A 800 Ekip Touch LSI	1SDA077302R1	Z2SCUFBE000A000000XX	1SDA077472R1	ZBSCUFBE000A000000XX
				E2.2S-A 800 Ekip Touch LSIG	1SDA077303R1	Z2SCUFBF000A000000XX	1SDA077473R1	ZBSCUFBF000A000000XX
				E2.2S-A 800 Ekip Hi-Touch LSI	1SDA077305R1	Z2SCUFBJ200A000000XX	1SDA077475R1	ZBSCUFBJ200A000000XX
				E2.2S-A 800 Ekip Hi-Touch LSIG	1SDA077306R1	Z2SCUFBK200A000000XX	1SDA077476R1	ZBSCUFBK200A000000XX
	1200	65	65	E2.2S-A 1200 Ekip Dip LI	1SDA077308R1	Z2SDUHBA000A000000XX	1SDA077478R1	ZBSDUHBA000A000000XX
				E2.2S-A 1200 Ekip Dip LSI	1SDA077309R1	Z2SDUHBB000A000000XX	1SDA077479R1	ZBSDUHBB000A000000XX
				E2.2S-A 1200 Ekip Dip LSIG	1SDA077310R1	Z2SDUHBC000A000000XX	1SDA077480R1	ZBSDUHBC000A000000XX
				E2.2S-A 1200 Ekip Touch LI	1SDA077311R1	Z2SDUHBD000A000000XX	1SDA077481R1	ZBSDUHBD000A000000XX
				E2.2S-A 1200 Ekip Touch LSI	1SDA077312R1	Z2SDUHBE000A000000XX	1SDA077482R1	ZBSDUHBE000A000000XX
				E2.2S-A 1200 Ekip Touch LSIG	1SDA077313R1	Z2SDUHBF000A000000XX	1SDA077483R1	ZBSDUHBF000A000000XX
				E2.2S-A 1200 Ekip Hi-Touch LSI	1SDA077315R1	Z2SDUHBJ200A000000XX	1SDA077485R1	ZBSDUHBJ200A000000XX
				E2.2S-A 1200 Ekip Hi-Touch LSIG	1SDA077316R1	Z2SDUHBK200A000000XX	1SDA077486R1	ZBSDUHBK200A000000XX
	1600	65	65	E2.2S-A 1600 Ekip Dip LI	1SDA077318R1	Z2SEUJBA000A000000XX	1SDA077488R1	ZBSEUJBA000A000000XX
				E2.2S-A 1600 Ekip Dip LSI	1SDA077319R1	Z2SEUJBB000A000000XX	1SDA077489R1	ZBSEUJBB000A000000XX
				E2.2S-A 1600 Ekip Dip LSIG	1SDA077320R1	Z2SEUJBC000A000000XX	1SDA077490R1	ZBSEUJBC000A000000XX
				E2.2S-A 1600 Ekip Touch LI	1SDA077321R1	Z2SEUJBD000A000000XX	1SDA077491R1	ZBSEUJBD000A000000XX
				E2.2S-A 1600 Ekip Touch LSI	1SDA077322R1	Z2SEUJBE000A000000XX	1SDA077492R1	ZBSEUJBE000A000000XX
				E2.2S-A 1600 Ekip Touch LSIG	1SDA077323R1	Z2SEUJBF000A000000XX	1SDA077493R1	ZBSEUJBF000A000000XX
				E2.2S-A 1600 Ekip Hi-Touch LSI	1SDA077325R1	Z2SEUJBJ200A000000XX	1SDA077495R1	ZBSEUJBJ200A000000XX
				E2.2S-A 1600 Ekip Hi-Touch LSIG	1SDA077326R1	Z2SEUJBK200A000000XX	1SDA077496R1	ZBSEUJBK200A000000XX
	2000	65	65	E2.2S-A 2000 Ekip Dip LI	1SDA077328R1	Z2SFUKBA000A000000XX	1SDA077498R1	ZBSFUKBA000A000000XX
				E2.2S-A 2000 Ekip Dip LSI	1SDA077329R1	Z2SFUKBB000A000000XX	1SDA077499R1	ZBSFUKBB000A000000XX
				E2.2S-A 2000 Ekip Dip LSIG	1SDA077330R1	Z2SFUKBC000A000000XX	1SDA077500R1	ZBSFUKBC000A000000XX
				E2.2S-A 2000 Ekip Touch LI	1SDA077331R1	Z2SFUKBD000A000000XX	1SDA077501R1	ZBSFUKBD000A000000XX
E2.2S-A 2000 Ekip Touch LSI				1SDA077332R1	Z2SFUKBE000A000000XX	1SDA077502R1	ZBSFUKBE000A000000XX	
E2.2S-A 2000 Ekip Touch LSIG				1SDA077333R1	Z2SFUKBF000A000000XX	1SDA077503R1	ZBSFUKBF000A000000XX	
E2.2S-A 2000 Ekip Hi-Touch LSI				1SDA077335R1	Z2SFUKBJ200A000000XX	1SDA077505R1	ZBSFUKBJ200A000000XX	
E2.2S-A 2000 Ekip Hi-Touch LSIG				1SDA077336R1	Z2SFUKBK200A000000XX	1SDA077506R1	ZBSFUKBK200A000000XX	

SACE Emax 2 low voltage power circuit breakers

Automatic circuit breakers

Fixed version for power distribution



SACE Emax 2 E2.2H-A • Orientable rear terminals (HR)

Size	Frame Amps	Int. Rating (kA@508V)	Withstand (kA)	Type	3 Poles		4 Poles	
					Global PN	US / CA PN	Global PN	US / CA PN
E2.2H-A	800	85	85	E2.2H-A 800 Ekip Dip LI	1SDA077238R1	Z2HCUFBA000A000000XX	1SDA077408R1	ZBHCUFBA000A000000XX
				E2.2H-A 800 Ekip Dip LSI	1SDA077239R1	Z2HCUFBB000A000000XX	1SDA077409R1	ZBHCUFBB000A000000XX
				E2.2H-A 800 Ekip Dip LSIG	1SDA077240R1	Z2HCUFBC000A000000XX	1SDA077410R1	ZBHCUFBC000A000000XX
				E2.2H-A 800 Ekip Touch LI	1SDA077241R1	Z2HCUFBD000A000000XX	1SDA077411R1	ZBHCUFBD000A000000XX
				E2.2H-A 800 Ekip Touch LSI	1SDA077242R1	Z2HCUFBE000A000000XX	1SDA077412R1	ZBHCUFBE000A000000XX
				E2.2H-A 800 Ekip Touch LSIG	1SDA077243R1	Z2HCUFBF000A000000XX	1SDA077413R1	ZBHCUFBF000A000000XX
				E2.2H-A 800 Ekip Hi-Touch LSI	1SDA077245R1	Z2HCUFBJ200A000000XX	1SDA077415R1	ZBHCUFBJ200A000000XX
				E2.2H-A 800 Ekip Hi-Touch LSIG	1SDA077246R1	Z2HCUFBK200A000000XX	1SDA077416R1	ZBHCUFBK200A000000XX
	1200	85	85	E2.2H-A 1200 Ekip Dip LI	1SDA077248R1	Z2HDUHBA000A000000XX	1SDA077418R1	ZBHDUHBA000A000000XX
				E2.2H-A 1200 Ekip Dip LSI	1SDA077249R1	Z2HDUHBB000A000000XX	1SDA077419R1	ZBHDUHBB000A000000XX
				E2.2H-A 1200 Ekip Dip LSIG	1SDA077250R1	Z2HDUHBC000A000000XX	1SDA077420R1	ZBHDUHBC000A000000XX
				E2.2H-A 1200 Ekip Touch LI	1SDA077251R1	Z2HDUHBD000A000000XX	1SDA077421R1	ZBHDUHBD000A000000XX
				E2.2H-A 1200 Ekip Touch LSI	1SDA077252R1	Z2HDUHBE000A000000XX	1SDA077422R1	ZBHDUHBE000A000000XX
				E2.2H-A 1200 Ekip Touch LSIG	1SDA077253R1	Z2HDUHBF000A000000XX	1SDA077423R1	ZBHDUHBF000A000000XX
				E2.2H-A 1200 Ekip Hi-Touch LSI	1SDA077255R1	Z2HDUHBJ200A000000XX	1SDA077425R1	ZBHDUHBJ200A000000XX
				E2.2H-A 1200 Ekip Hi-Touch LSIG	1SDA077256R1	Z2HDUHBK200A000000XX	1SDA077426R1	ZBHDUHBK200A000000XX
	1600	85	85	E2.2H-A 1600 Ekip Dip LI	1SDA077258R1	Z2HEUJBA000A000000XX	1SDA077428R1	ZBHEUJBA000A000000XX
				E2.2H-A 1600 Ekip Dip LSI	1SDA077259R1	Z2HEUJBB000A000000XX	1SDA077429R1	ZBHEUJBB000A000000XX
				E2.2H-A 1600 Ekip Dip LSIG	1SDA077260R1	Z2HEUJBC000A000000XX	1SDA077430R1	ZBHEUJBC000A000000XX
				E2.2H-A 1600 Ekip Touch LI	1SDA077261R1	Z2HEUJBD000A000000XX	1SDA077431R1	ZBHEUJBD000A000000XX
				E2.2H-A 1600 Ekip Touch LSI	1SDA077262R1	Z2HEUJBE000A000000XX	1SDA077432R1	ZBHEUJBE000A000000XX
				E2.2H-A 1600 Ekip Touch LSIG	1SDA077263R1	Z2HEUJBF000A000000XX	1SDA077433R1	ZBHEUJBF000A000000XX
				E2.2H-A 1600 Ekip Hi-Touch LSI	1SDA077265R1	Z2HEUJBJ200A000000XX	1SDA077435R1	ZBHEUJBJ200A000000XX
				E2.2H-A 1600 Ekip Hi-Touch LSIG	1SDA077266R1	Z2HEUJBK200A000000XX	1SDA077436R1	ZBHEUJBK200A000000XX
	2000	85	85	E2.2H-A 2000 Ekip Dip LI	1SDA077268R1	Z2HFUKBA000A000000XX	1SDA077438R1	ZBHFUKBA000A000000XX
				E2.2H-A 2000 Ekip Dip LSI	1SDA077269R1	Z2HFUKBB000A000000XX	1SDA077439R1	ZBHFUKBB000A000000XX
				E2.2H-A 2000 Ekip Dip LSIG	1SDA077270R1	Z2HFUKBC000A000000XX	1SDA077440R1	ZBHFUKBC000A000000XX
				E2.2H-A 2000 Ekip Touch LI	1SDA077271R1	Z2HFUKBD000A000000XX	1SDA077441R1	ZBHFUKBD000A000000XX
E2.2H-A 2000 Ekip Touch LSI				1SDA077272R1	Z2HFUKBE000A000000XX	1SDA077442R1	ZBHFUKBE000A000000XX	
E2.2H-A 2000 Ekip Touch LSIG				1SDA077273R1	Z2HFUKBF000A000000XX	1SDA077443R1	ZBHFUKBF000A000000XX	
E2.2H-A 2000 Ekip Hi-Touch LSI				1SDA077275R1	Z2HFUKBJ200A000000XX	1SDA077445R1	ZBHFUKBJ200A000000XX	
E2.2H-A 2000 Ekip Hi-Touch LSIG				1SDA077276R1	Z2HFUKBK200A000000XX	1SDA077446R1	ZBHFUKBK200A000000XX	

SACE Emax 2 low voltage power circuit breakers

Automatic circuit breakers

Fixed version for power distribution



SACE Emax 2 E2.2V-A • Orientable rear terminals (HR)

Size	Frame Amps	Int. Rating (kA@508V)	Withstand (kA)	Type	3 Poles		4 Poles	
					Global PN	US / CA PN	Global PN	US / CA PN
E2.2V-A	250	100	85	E2.2V-A 250 Ekip Dip LI	1SDA077338R1	Z2VAUCBA000A000000XX	1SDA077508R1	ZBVAUCBA000A000000XX
				E2.2V-A 250 Ekip Dip LSI	1SDA077339R1	Z2VAUCBB000A000000XX	1SDA077509R1	ZBVAUCBB000A000000XX
				E2.2V-A 250 Ekip Dip LSIG	1SDA077340R1	Z2VAUCBC000A000000XX	1SDA077510R1	ZBVAUCBC000A000000XX
				E2.2V-A 250 Ekip Touch LI	1SDA077341R1	Z2VAUCBD000A000000XX	1SDA077511R1	ZBVAUCBD000A000000XX
				E2.2V-A 250 Ekip Touch LSI	1SDA077342R1	Z2VAUCBE000A000000XX	1SDA077512R1	ZBVAUCBE000A000000XX
				E2.2V-A 250 Ekip Touch LSIG	1SDA077343R1	Z2VAUCBF000A000000XX	1SDA077513R1	ZBVAUCBF000A000000XX
				E2.2V-A 250 Ekip Hi-Touch LSI	1SDA077345R1	Z2VAUCBJ200A000000XX	1SDA077515R1	ZBVAUCBJ200A000000XX
	E2.2V-A 250 Ekip Hi-Touch LSIG	1SDA077346R1	Z2VAUCBK200A000000XX	1SDA077516R1	ZBVAUCBK200A000000XX			
	400	100	85	E2.2V-A 400 Ekip Dip LI	1SDA077348R1	Z2VBUDBA000A000000XX	1SDA077518R1	ZBVBUDBA000A000000XX
				E2.2V-A 400 Ekip Dip LSI	1SDA077349R1	Z2VBUDBB000A000000XX	1SDA077519R1	ZBVBUDBB000A000000XX
				E2.2V-A 400 Ekip Dip LSIG	1SDA077350R1	Z2VBUDBC000A000000XX	1SDA077520R1	ZBVBUDBC000A000000XX
				E2.2V-A 400 Ekip Touch LI	1SDA077351R1	Z2VBUDBD000A000000XX	1SDA077521R1	ZBVBUDBD000A000000XX
				E2.2V-A 400 Ekip Touch LSI	1SDA077352R1	Z2VBUDBE000A000000XX	1SDA077522R1	ZBVBUDBE000A000000XX
				E2.2V-A 400 Ekip Touch LSIG	1SDA077353R1	Z2VBUDBF000A000000XX	1SDA077523R1	ZBVBUDBF000A000000XX
				E2.2V-A 400 Ekip Hi-Touch LSI	1SDA077355R1	Z2VBUDBJ200A000000XX	1SDA077525R1	ZBVBUDBJ200A000000XX
	E2.2V-A 400 Ekip Hi-Touch LSIG	1SDA077356R1	Z2VBUDBK200A000000XX	1SDA077526R1	ZBVBUDBK200A000000XX			
	800	100	85	E2.2V-A 800 Ekip Dip LI	1SDA077358R1	Z2VCUFBA000A000000XX	1SDA077528R1	ZBVCUFBA000A000000XX
				E2.2V-A 800 Ekip Dip LSI	1SDA077359R1	Z2VCUFBB000A000000XX	1SDA077529R1	ZBVCUFBB000A000000XX
				E2.2V-A 800 Ekip Dip LSIG	1SDA077360R1	Z2VCUFBC000A000000XX	1SDA077530R1	ZBVCUFBC000A000000XX
				E2.2V-A 800 Ekip Touch LI	1SDA077361R1	Z2VCUFBD000A000000XX	1SDA077531R1	ZBVCUFBD000A000000XX
				E2.2V-A 800 Ekip Touch LSI	1SDA077362R1	Z2VCUFBE000A000000XX	1SDA077532R1	ZBVCUFBE000A000000XX
				E2.2V-A 800 Ekip Touch LSIG	1SDA077363R1	Z2VCUFBF000A000000XX	1SDA077533R1	ZBVCUFBF000A000000XX
				E2.2V-A 800 Ekip Hi-Touch LSI	1SDA077365R1	Z2VCUFBJ200A000000XX	1SDA077535R1	ZBVCUFBJ200A000000XX
	E2.2V-A 800 Ekip Hi-Touch LSIG	1SDA077366R1	Z2VCUFBK200A000000XX	1SDA077536R1	ZBVCUFBK200A000000XX			
	1200	100	85	E2.2V-A 1200 Ekip Dip LI	1SDA077368R1	Z2VDUHBA000A000000XX	1SDA077538R1	ZBVDUHBA000A000000XX
				E2.2V-A 1200 Ekip Dip LSI	1SDA077369R1	Z2VDUHBB000A000000XX	1SDA077539R1	ZBVDUHBB000A000000XX
				E2.2V-A 1200 Ekip Dip LSIG	1SDA077370R1	Z2VDUHBC000A000000XX	1SDA077540R1	ZBVDUHBC000A000000XX
				E2.2V-A 1200 Ekip Touch LI	1SDA077371R1	Z2VDUHBD000A000000XX	1SDA077541R1	ZBVDUHBD000A000000XX
				E2.2V-A 1200 Ekip Touch LSI	1SDA077372R1	Z2VDUHBE000A000000XX	1SDA077542R1	ZBVDUHBE000A000000XX
				E2.2V-A 1200 Ekip Touch LSIG	1SDA077373R1	Z2VDUHBF000A000000XX	1SDA077543R1	ZBVDUHBF000A000000XX
				E2.2V-A 1200 Ekip Hi-Touch LSI	1SDA077375R1	Z2VDUHBJ200A000000XX	1SDA077545R1	ZBVDUHBJ200A000000XX
	E2.2V-A 1200 Ekip Hi-Touch LSIG	1SDA077376R1	Z2VDUHBK200A000000XX	1SDA077546R1	ZBVDUHBK200A000000XX			
	1600	100	85	E2.2V-A 1600 Ekip Dip LI	1SDA077378R1	Z2VEUJBA000A000000XX	1SDA077548R1	ZBVEUJBA000A000000XX
				E2.2V-A 1600 Ekip Dip LSI	1SDA077379R1	Z2VEUJBB000A000000XX	1SDA077549R1	ZBVEUJBB000A000000XX
				E2.2V-A 1600 Ekip Dip LSIG	1SDA077380R1	Z2VEUJBC000A000000XX	1SDA077550R1	ZBVEUJBC000A000000XX
				E2.2V-A 1600 Ekip Touch LI	1SDA077381R1	Z2VEUJBD000A000000XX	1SDA077551R1	ZBVEUJBD000A000000XX
				E2.2V-A 1600 Ekip Touch LSI	1SDA077382R1	Z2VEUJBE000A000000XX	1SDA077552R1	ZBVEUJBE000A000000XX
				E2.2V-A 1600 Ekip Touch LSIG	1SDA077383R1	Z2VEUJBF000A000000XX	1SDA077553R1	ZBVEUJBF000A000000XX
				E2.2V-A 1600 Ekip Hi-Touch LSI	1SDA077385R1	Z2VEUJBJ200A000000XX	1SDA077555R1	ZBVEUJBJ200A000000XX
	E2.2V-A 1600 Ekip Hi-Touch LSIG	1SDA077386R1	Z2VEUJBK200A000000XX	1SDA077556R1	ZBVEUJBK200A000000XX			
	2000	100	85	E2.2V-A 2000 Ekip Dip LI	1SDA077388R1	Z2VFUKBA000A000000XX	1SDA077558R1	ZBVFUKBA000A000000XX
				E2.2V-A 2000 Ekip Dip LSI	1SDA077389R1	Z2VFUKBB000A000000XX	1SDA077559R1	ZBVFUKBB000A000000XX
E2.2V-A 2000 Ekip Dip LSIG				1SDA077390R1	Z2VFUKBC000A000000XX	1SDA077560R1	ZBVFUKBC000A000000XX	
E2.2V-A 2000 Ekip Touch LI				1SDA077391R1	Z2VFUKBD000A000000XX	1SDA077561R1	ZBVFUKBD000A000000XX	
E2.2V-A 2000 Ekip Touch LSI				1SDA077392R1	Z2VFUKBE000A000000XX	1SDA077562R1	ZBVFUKBE000A000000XX	
E2.2V-A 2000 Ekip Touch LSIG				1SDA077393R1	Z2VFUKBF000A000000XX	1SDA077563R1	ZBVFUKBF000A000000XX	
E2.2V-A 2000 Ekip Hi-Touch LSI				1SDA077395R1	Z2VFUKBJ200A000000XX	1SDA077565R1	ZBVFUKBJ200A000000XX	
E2.2V-A 2000 Ekip Hi-Touch LSIG	1SDA077396R1	Z2VFUKBK200A000000XX	1SDA077566R1	ZBVFUKBK200A000000XX				

SACE Emax 2 low voltage power circuit breakers

Automatic circuit breakers

Fixed version for power distribution



SACE Emax 2 E4.2S-A/H-A • Orientable rear terminals up to 2500 A (HR)

Size	Frame Amps	Int. Rating (kA@508V)	Withstand (kA)	Type	3 Poles		4 Poles		
					Global PN	US / CA PN	Global PN	US / CA PN	
E4.2S-A	2500	65	65	E4.2S-A 2500 Ekip Dip LI	1SDA077998R1	Z4SGULBA000A0000000XX	1SDA078228R1	ZCSGULBA000A0000000XX	
				E4.2S-A 2500 Ekip Dip LSI	1SDA077999R1	Z4SGULBB000A0000000XX	1SDA078229R1	ZCSGULBB000A0000000XX	
				E4.2S-A 2500 Ekip Dip LSIG	1SDA078000R1	Z4SGULBC000A0000000XX	1SDA078230R1	ZCSGULBC000A0000000XX	
				E4.2S-A 2500 Ekip Touch LI	1SDA078001R1	Z4SGULBD000A0000000XX	1SDA078231R1	ZCSGULBD000A0000000XX	
				E4.2S-A 2500 Ekip Touch LSI	1SDA078002R1	Z4SGULBE000A0000000XX	1SDA078232R1	ZCSGULBE000A0000000XX	
				E4.2S-A 2500 Ekip Touch LSIG	1SDA078003R1	Z4SGULBF000A0000000XX	1SDA078233R1	ZCSGULBF000A0000000XX	
				E4.2S-A 2500 Ekip Hi-Touch LSI	1SDA078005R1	Z4SGULBJ200A0000000XX	1SDA078235R1	ZCSGULBJ200A0000000XX	
	E4.2S-A 2500 Ekip Hi-Touch LSIG	1SDA078006R1	Z4SGULBK200A0000000XX	1SDA078236R1	ZCSGULBK200A0000000XX				
	3200	65	65	E4.2S-A 3200 Ekip Dip LI	1SDA078008R1	Z4SHUNBA000A0000000XX	1SDA078238R1	ZCSHUNBA000A0000000XX	
				E4.2S-A 3200 Ekip Dip LSI	1SDA078009R1	Z4SHUNBB000A0000000XX	1SDA078239R1	ZCSHUNBB000A0000000XX	
				E4.2S-A 3200 Ekip Dip LSIG	1SDA078010R1	Z4SHUNBC000A0000000XX	1SDA078240R1	ZCSHUNBC000A0000000XX	
				E4.2S-A 3200 Ekip Touch LI	1SDA078011R1	Z4SHUNBD000A0000000XX	1SDA078241R1	ZCSHUNBD000A0000000XX	
				E4.2S-A 3200 Ekip Touch LSI	1SDA078012R1	Z4SHUNBE000A0000000XX	1SDA078242R1	ZCSHUNBE000A0000000XX	
				E4.2S-A 3200 Ekip Touch LSIG	1SDA078013R1	Z4SHUNBF000A0000000XX	1SDA078243R1	ZCSHUNBF000A0000000XX	
				E4.2S-A 3200 Ekip Hi-Touch LSI	1SDA078015R1	Z4SHUNBJ200A0000000XX	1SDA078245R1	ZCSHUNBJ200A0000000XX	
	E4.2S-A 3200 Ekip Hi-Touch LSIG	1SDA078016R1	Z4SHUNBK200A0000000XX	1SDA078246R1	ZCSHUNBK200A0000000XX				
	3600	65	65	E4.2S-A 3600 Ekip Dip LI	1SDA078018R1	Z4SZUSBA000A0000000XX	-	-	
				E4.2S-A 3600 Ekip Dip LSI	1SDA078019R1	Z4SZUSBB000A0000000XX	-	-	
				E4.2S-A 3600 Ekip Dip LSIG	1SDA078020R1	Z4SZUSBC000A0000000XX	-	-	
				E4.2S-A 3600 Ekip Touch LI	1SDA078021R1	Z4SZUSBD000A0000000XX	-	-	
				E4.2S-A 3600 Ekip Touch LSI	1SDA078022R1	Z4SZUSBE000A0000000XX	-	-	
				E4.2S-A 3600 Ekip Touch LSIG	1SDA078023R1	Z4SZUSBF000A0000000XX	-	-	
				E4.2S-A 3600 Ekip Hi-Touch LSI	1SDA078025R1	Z4SZUSBJ200A0000000XX	-	-	
	E4.2S-A 3600 Ekip Hi-Touch LSIG	1SDA078026R1	Z4SZUSBK200A0000000XX	-	-				
	E4.2H-A	2500	85	85	E4.2H-A 2500 Ekip Dip LI	1SDA077908R1	Z4HGULBA000A0000000XX	1SDA078138R1	ZCHGULBA000A0000000XX
					E4.2H-A 2500 Ekip Dip LSI	1SDA077909R1	Z4HGULBB000A0000000XX	1SDA078139R1	ZCHGULBB000A0000000XX
					E4.2H-A 2500 Ekip Dip LSIG	1SDA077910R1	Z4HGULBC000A0000000XX	1SDA078140R1	ZCHGULBC000A0000000XX
					E4.2H-A 2500 Ekip Touch LI	1SDA077911R1	Z4HGULBD000A0000000XX	1SDA078141R1	ZCHGULBD000A0000000XX
E4.2H-A 2500 Ekip Touch LSI					1SDA077912R1	Z4HGULBE000A0000000XX	1SDA078142R1	ZCHGULBE000A0000000XX	
E4.2H-A 2500 Ekip Touch LSIG					1SDA077913R1	Z4HGULBF000A0000000XX	1SDA078143R1	ZCHGULBF000A0000000XX	
E4.2H-A 2500 Ekip Hi-Touch LSI					1SDA077915R1	Z4HGULBJ200A0000000XX	1SDA078145R1	ZCHGULBJ200A0000000XX	
E4.2H-A 2500 Ekip Hi-Touch LSIG		1SDA077916R1	Z4HGULBK200A0000000XX	1SDA078146R1	ZCHGULBK200A0000000XX				
3200		85	85	E4.2H-A 3200 Ekip Dip LI	1SDA077918R1	Z4HHUNBA000A0000000XX	1SDA078148R1	ZCHHUNBA000A0000000XX	
				E4.2H-A 3200 Ekip Dip LSI	1SDA077919R1	Z4HHUNBB000A0000000XX	1SDA078149R1	ZCHHUNBB000A0000000XX	
				E4.2H-A 3200 Ekip Dip LSIG	1SDA077920R1	Z4HHUNBC000A0000000XX	1SDA078150R1	ZCHHUNBC000A0000000XX	
				E4.2H-A 3200 Ekip Touch LI	1SDA077921R1	Z4HHUNBD000A0000000XX	1SDA078151R1	ZCHHUNBD000A0000000XX	
				E4.2H-A 3200 Ekip Touch LSI	1SDA077922R1	Z4HHUNBE000A0000000XX	1SDA078152R1	ZCHHUNBE000A0000000XX	
				E4.2H-A 3200 Ekip Touch LSIG	1SDA077923R1	Z4HHUNBF000A0000000XX	1SDA078153R1	ZCHHUNBF000A0000000XX	
				E4.2H-A 3200 Ekip Hi-Touch LSI	1SDA077925R1	Z4HHUNBJ200A0000000XX	1SDA078155R1	ZCHHUNBJ200A0000000XX	
E4.2H-A 3200 Ekip Hi-Touch LSIG		1SDA077926R1	Z4HHUNBK200A0000000XX	1SDA078156R1	ZCHHUNBK200A0000000XX				
3600		65	65	E4.2H-A 3600 Ekip Dip LI	1SDA077928R1	Z4HZUSBA000A0000000XX	-	-	
				E4.2H-A 3600 Ekip Dip LSI	1SDA077929R1	Z4HZUSBB000A0000000XX	-	-	
				E4.2H-A 3600 Ekip Dip LSIG	1SDA077930R1	Z4HZUSBC000A0000000XX	-	-	
				E4.2H-A 3600 Ekip Touch LI	1SDA077931R1	Z4HZUSBD000A0000000XX	-	-	
				E4.2H-A 3600 Ekip Touch LSI	1SDA077932R1	Z4HZUSBE000A0000000XX	-	-	
				E4.2H-A 3600 Ekip Touch LSIG	1SDA077933R1	Z4HZUSBF000A0000000XX	-	-	
				E4.2H-A 3600 Ekip Hi-Touch LSI	1SDA077935R1	Z4HZUSBJ200A0000000XX	-	-	
E4.2H-A 3600 Ekip Hi-Touch LSIG		1SDA077936R1	Z4HZUSBK200A0000000XX	-	-				

*3200A/3600A ratings only with rear vertical terminals

SACE Emax 2 low voltage power circuit breakers

Automatic circuit breakers

Fixed version for power distribution



SACE Emax 2 E4.2V-A • Orientable rear terminals up to 2500 A (HR)

Size	Frame Amps	Int. Rating (kA@508V)	Withstand (kA)	Type	3 Poles		4 Poles	
					Global PN	US / CA PN	Global PN	US / CA PN
E4.2V-A	800	100	85	E4.2V-A 800 Ekip Dip LI	1SDA078028R1	Z4VCUFBA000A000000XX	1SDA078258R1	ZCVCUFBA000A000000XX
				E4.2V-A 800 Ekip Dip LSI	1SDA078029R1	Z4VCUFBB000A000000XX	1SDA078259R1	ZCVCUFBB000A000000XX
				E4.2V-A 800 Ekip Dip LSIG	1SDA078030R1	Z4VCUFBC000A000000XX	1SDA078260R1	ZCVCUFBC000A000000XX
				E4.2V-A 800 Ekip Touch LI	1SDA078031R1	Z4VCUFBD000A000000XX	1SDA078261R1	ZCVCUFBD000A000000XX
				E4.2V-A 800 Ekip Touch LSI	1SDA078032R1	Z4VCUFBE000A000000XX	1SDA078262R1	ZCVCUFBE000A000000XX
				E4.2V-A 800 Ekip Touch LSIG	1SDA078033R1	Z4VCUFBF000A000000XX	1SDA078263R1	ZCVCUFBF000A000000XX
				E4.2V-A 800 Ekip Hi-Touch LSI	1SDA078035R1	Z4VCUFBJ200A000000XX	1SDA078265R1	ZCVCUFBJ200A000000XX
				E4.2V-A 800 Ekip Hi-Touch LSIG	1SDA078036R1	Z4VCUFBK200A000000XX	1SDA078266R1	ZCVCUFBK200A000000XX
	1600	100	85	E4.2V-A 1600 Ekip Dip LI	1SDA078038R1	Z4VEUJBA000A000000XX	1SDA078268R1	ZCVEUJBA000A000000XX
				E4.2V-A 1600 Ekip Dip LSI	1SDA078039R1	Z4VEUJBB000A000000XX	1SDA078269R1	ZCVEUJBB000A000000XX
				E4.2V-A 1600 Ekip Dip LSIG	1SDA078040R1	Z4VEUJBC000A000000XX	1SDA078270R1	ZCVEUJBC000A000000XX
				E4.2V-A 1600 Ekip Touch LI	1SDA078041R1	Z4VEUJBD000A000000XX	1SDA078271R1	ZCVEUJBD000A000000XX
				E4.2V-A 1600 Ekip Touch LSI	1SDA078042R1	Z4VEUJBE000A000000XX	1SDA078272R1	ZCVEUJBE000A000000XX
				E4.2V-A 1600 Ekip Touch LSIG	1SDA078043R1	Z4VEUJBF000A000000XX	1SDA078273R1	ZCVEUJBF000A000000XX
				E4.2V-A 1600 Ekip Hi-Touch LSI	1SDA078045R1	Z4VEUJBJ200A000000XX	1SDA078275R1	ZCVEUJBJ200A000000XX
				E4.2V-A 1600 Ekip Hi-Touch LSIG	1SDA078046R1	Z4VEUJBK200A000000XX	1SDA078276R1	ZCVEUJBK200A000000XX
	2000	100	85	E4.2V-A 2000 Ekip Dip LI	1SDA078048R1	Z4VFUKBA000A000000XX	1SDA078278R1	ZCVFUKBA000A000000XX
				E4.2V-A 2000 Ekip Dip LSI	1SDA078049R1	Z4VFUKBB000A000000XX	1SDA078279R1	ZCVFUKBB000A000000XX
				E4.2V-A 2000 Ekip Dip LSIG	1SDA078050R1	Z4VFUKBC000A000000XX	1SDA078280R1	ZCVFUKBC000A000000XX
				E4.2V-A 2000 Ekip Touch LI	1SDA078051R1	Z4VFUKBD000A000000XX	1SDA078281R1	ZCVFUKBD000A000000XX
				E4.2V-A 2000 Ekip Touch LSI	1SDA078052R1	Z4VFUKBE000A000000XX	1SDA078282R1	ZCVFUKBE000A000000XX
				E4.2V-A 2000 Ekip Touch LSIG	1SDA078053R1	Z4VFUKBF000A000000XX	1SDA078283R1	ZCVFUKBF000A000000XX
				E4.2V-A 2000 Ekip Hi-Touch LSI	1SDA078055R1	Z4VFUKBJ200A000000XX	1SDA078285R1	ZCVFUKBJ200A000000XX
				E4.2V-A 2000 Ekip Hi-Touch LSIG	1SDA078056R1	Z4VFUKBK200A000000XX	1SDA078286R1	ZCVFUKBK200A000000XX
	2500	100	85	E4.2V-A 2500 Ekip Dip LI	1SDA078058R1	Z4VGULBA000A000000XX	1SDA078288R1	ZCVGULBA000A000000XX
				E4.2V-A 2500 Ekip Dip LSI	1SDA078059R1	Z4VGULBB000A000000XX	1SDA078289R1	ZCVGULBB000A000000XX
				E4.2V-A 2500 Ekip Dip LSIG	1SDA078060R1	Z4VGULBC000A000000XX	1SDA078290R1	ZCVGULBC000A000000XX
				E4.2V-A 2500 Ekip Touch LI	1SDA078061R1	Z4VGULBD000A000000XX	1SDA078291R1	ZCVGULBD000A000000XX
E4.2V-A 2500 Ekip Touch LSI				1SDA078062R1	Z4VGULBE000A000000XX	1SDA078292R1	ZCVGULBE000A000000XX	
E4.2V-A 2500 Ekip Touch LSIG				1SDA078063R1	Z4VGULBF000A000000XX	1SDA078293R1	ZCVGULBF000A000000XX	
E4.2V-A 2500 Ekip Hi-Touch LSI				1SDA078065R1	Z4VGULBJ200A000000XX	1SDA078295R1	ZCVGULBJ200A000000XX	
E4.2V-A 2500 Ekip Hi-Touch LSIG				1SDA078066R1	Z4VGULBK200A000000XX	1SDA078296R1	ZCVGULBK200A000000XX	

SACE Emax 2 low voltage power circuit breakers

Automatic circuit breakers

Fixed version for power distribution



SACE Emax 2 E4.2V-A - Orientable rear terminals up to 2500 A (HR)

Size	Frame Amps	Int. Rating (kA@508V)	Withstand (kA)	Type	3 Poles		4 Poles	
					Global PN	US / CA PN	Global PN	US / CA PN
E4.2V-A	3200*	100	85	E4.2V-A 3200 Ekip Dip LI	1SDA078068R1	Z4VHUNBA000A0000000XX	1SDA078298R1	ZCVHUNBA000A0000000XX
				E4.2V-A 3200 Ekip Dip LSI	1SDA078069R1	Z4VHUNBB000A0000000XX	1SDA078299R1	ZCVHUNBB000A0000000XX
				E4.2V-A 3200 Ekip Dip LSIG	1SDA078070R1	Z4VHUNBC000A0000000XX	1SDA078300R1	ZCVHUNBC000A0000000XX
				E4.2V-A 3200 Ekip Touch LI	1SDA078071R1	Z4VHUNBD000A0000000XX	1SDA078301R1	ZCVHUNBD000A0000000XX
				E4.2V-A 3200 Ekip Touch LSI	1SDA078072R1	Z4VHUNBE000A0000000XX	1SDA078302R1	ZCVHUNBE000A0000000XX
				E4.2V-A 3200 Ekip Touch LSIG	1SDA078073R1	Z4VHUNBF000A0000000XX	1SDA078303R1	ZCVHUNBF000A0000000XX
				E4.2V-A 3200 Ekip Hi-Touch LSI	1SDA078075R1	Z4VHUNBJ200A0000000XX	1SDA078305R1	ZCVHUNBJ200A0000000XX
				E4.2V-A 3200 Ekip Hi-Touch LSIG	1SDA078076R1	Z4VHUNBK200A0000000XX	1SDA078306R1	ZCVHUNBK200A0000000XX
	3600*	100	85	E4.2V-A 3600 Ekip Dip LI	1SDA078078R1	Z4VZUSBA000A0000000XX	-	-
				E4.2V-A 3600 Ekip Dip LSI	1SDA078079R1	Z4VZUSBB000A0000000XX	-	-
				E4.2V-A 3600 Ekip Dip LSIG	1SDA078080R1	Z4VZUSBC000A0000000XX	-	-
				E4.2V-A 3600 Ekip Touch LI	1SDA078081R1	Z4VZUSBD000A0000000XX	-	-
				E4.2V-A 3600 Ekip Touch LSI	1SDA078082R1	Z4VZUSBE000A0000000XX	-	-
				E4.2V-A 3600 Ekip Touch LSIG	1SDA078083R1	Z4VZUSBF000A0000000XX	-	-
			E4.2V-A 3600 Ekip Hi-Touch LSI	1SDA078085R1	Z4VZUSBJ200A0000000XX	-	-	
			E4.2V-A 3600 Ekip Hi-Touch LSIG	1SDA078086R1	Z4VZUSBK200A0000000XX	-	-	

*3200A/3600A ratings only with rear vertical terminals

SACE Emax 2 low voltage power circuit breakers

Automatic circuit breakers

Fixed version for power distribution



SACE Emax 2 E6.2H-A/V-A • Orientable rear terminals up to 5000A (HR)

Size	Frame Amps	Int. Rating (kA@508V)	Withstand (kA)	Type	3 Poles		4 Poles	
					Global PN	US / CA PN	Global PN	US / CA PN
E6.2H-A	4000	85	85	E6.2H-A 4000 Ekip Dip LI	1SDA078828R1	Z6HJURBA000A000000XX	1SDA078948R1	ZDHJURBA000A000000XX
				E6.2H-A 4000 Ekip Dip LSI	1SDA078829R1	Z6HJURBB000A000000XX	1SDA078949R1	ZDHJURBB000A000000XX
				E6.2H-A 4000 Ekip Dip LSIG	1SDA078830R1	Z6HJURBC000A000000XX	1SDA078950R1	ZDHJURBC000A000000XX
				E6.2H-A 4000 Ekip Touch LI	1SDA078831R1	Z6HJURBD000A000000XX	1SDA078951R1	ZDHJURBD000A000000XX
				E6.2H-A 4000 Ekip Touch LSI	1SDA078832R1	Z6HJURBE000A000000XX	1SDA078952R1	ZDHJURBE000A000000XX
				E6.2H-A 4000 Ekip Touch LSIG	1SDA078833R1	Z6HJURBF000A000000XX	1SDA078953R1	ZDHJURBF000A000000XX
				E6.2H-A 4000 Ekip Hi-Touch LSI	1SDA078835R1	Z6HJURBJ200A000000XX	1SDA078955R1	ZDHJURBJ200A000000XX
	E6.2H-A 4000 Ekip Hi-Touch LSIG	1SDA078836R1	Z6HJURBK200A000000XX	1SDA078956R1	ZDHJURBK200A000000XX			
	5000	85	85	E6.2H-A 5000 Ekip Dip LI	1SDA078838R1	Z6HKUSBA000A000000XX	1SDA078958R1	ZDHKUSBA000A000000XX
				E6.2H-A 5000 Ekip Dip LSI	1SDA078839R1	Z6HKUSBB000A000000XX	1SDA078959R1	ZDHKUSBB000A000000XX
				E6.2H-A 5000 Ekip Dip LSIG	1SDA078840R1	Z6HKUSBC000A000000XX	1SDA078960R1	ZDHKUSBC000A000000XX
				E6.2H-A 5000 Ekip Touch LI	1SDA078841R1	Z6HKUSBD000A000000XX	1SDA078961R1	ZDHKUSBD000A000000XX
				E6.2H-A 5000 Ekip Touch LSI	1SDA078842R1	Z6HKUSBE000A000000XX	1SDA078962R1	ZDHKUSBE000A000000XX
				E6.2H-A 5000 Ekip Touch LSIG	1SDA078843R1	Z6HKUSBF000A000000XX	1SDA078963R1	ZDHKUSBF000A000000XX
E6.2H-A 5000 Ekip Hi-Touch LSI				1SDA078845R1	Z6HKUSBJ200A000000XX	1SDA078965R1	ZDHKUSBJ200A000000XX	
E6.2H-A 5000 Ekip Hi-Touch LSIG	1SDA078846R1	Z6HKUSBK200A000000XX	1SDA078966R1	ZDHKUSBK200A000000XX				
E6.2V-A	4000	100	100	E6.2V-A 4000 Ekip Dip LI	1SDA078888R1	Z6VJURBA000A000000XX	1SDA079008R1	ZDVJURBA000A000000XX
				E6.2V-A 4000 Ekip Dip LSI	1SDA078889R1	Z6VJURBB000A000000XX	1SDA079009R1	ZDVJURBB000A000000XX
				E6.2V-A 4000 Ekip Dip LSIG	1SDA078890R1	Z6VJURBC000A000000XX	1SDA079010R1	ZDVJURBC000A000000XX
				E6.2V-A 4000 Ekip Touch LI	1SDA078891R1	Z6VJURBD000A000000XX	1SDA079011R1	ZDVJURBD000A000000XX
				E6.2V-A 4000 Ekip Touch LSI	1SDA078892R1	Z6VJURBE000A000000XX	1SDA079012R1	ZDVJURBE000A000000XX
				E6.2V-A 4000 Ekip Touch LSIG	1SDA078893R1	Z6VJURBF000A000000XX	1SDA079013R1	ZDVJURBF000A000000XX
				E6.2V-A 4000 Ekip Hi-Touch LSI	1SDA078895R1	Z6VJURBJ200A000000XX	1SDA079015R1	ZDVJURBJ200A000000XX
	E6.2V-A 4000 Ekip Hi-Touch LSIG	1SDA078896R1	Z6VJURBK200A000000XX	1SDA079016R1	ZDVJURBK200A000000XX			
	5000	100	100	E6.2V-A 5000 Ekip Dip LI	1SDA078898R1	Z6VKUSBA000A000000XX	1SDA079018R1	ZDVKUSBA000A000000XX
				E6.2V-A 5000 Ekip Dip LSI	1SDA078899R1	Z6VKUSBB000A000000XX	1SDA079019R1	ZDVKUSBB000A000000XX
				E6.2V-A 5000 Ekip Dip LSIG	1SDA078900R1	Z6VKUSBC000A000000XX	1SDA079020R1	ZDVKUSBC000A000000XX
				E6.2V-A 5000 Ekip Touch LI	1SDA078901R1	Z6VKUSBD000A000000XX	1SDA079021R1	ZDVKUSBD000A000000XX
				E6.2V-A 5000 Ekip Touch LSI	1SDA078902R1	Z6VKUSBE000A000000XX	1SDA079022R1	ZDVKUSBE000A000000XX
				E6.2V-A 5000 Ekip Touch LSIG	1SDA078903R1	Z6VKUSBF000A000000XX	1SDA079023R1	ZDVKUSBF000A000000XX
E6.2V-A 5000 Ekip Hi-Touch LSI				1SDA078905R1	Z6VKUSBJ200A000000XX	1SDA079025R1	ZDVKUSBJ200A000000XX	
E6.2V-A 5000 Ekip Hi-Touch LSIG	1SDA078906R1	Z6VKUSBK200A000000XX	1SDA079026R1	ZDVKUSBK200A000000XX				

* 6000A ratings only with rear vertical terminals.

SACE Emax 2 low voltage power circuit breakers

Automatic circuit breakers

Fixed version for power distribution



SACE Emax 2 E6.2H-A/f/V-A/f full size • Orientable rear terminals up to 5000A (HR)

Size	Frame Amps	Int. Rating (kA@508V)	Withstand (kA)	Type	4 Poles	
					Global PN	US / CA PN
E6.2H-A/f	4000	85	85	E6.2H-A/f 4000 Ekip Dip LI	1SDA079308R1	ZEHJURBA000A000000XX
				E6.2H-A/f 4000 Ekip Dip LSI	1SDA079309R1	ZEHJURBB000A000000XX
				E6.2H-A/f 4000 Ekip Dip LSIG	1SDA079310R1	ZEHJURBC000A000000XX
				E6.2H-A/f 4000 Ekip Touch LI	1SDA079311R1	ZEHJURBD000A000000XX
				E6.2H-A/f 4000 Ekip Touch LSI	1SDA079312R1	ZEHJURBE000A000000XX
				E6.2H-A/f 4000 Ekip Touch LSIG	1SDA079313R1	ZEHJURBF000A000000XX
				E6.2H-A/f 4000 Ekip Hi-Touch LSI	1SDA079315R1	ZEHJURBJ200A000000XX
				E6.2H-A/f 4000 Ekip Hi-Touch LSIG	1SDA079316R1	ZEHJURBK200A000000XX
	5000	85	85	E6.2H-A/f 5000 Ekip Dip LI	1SDA079318R1	ZEHKUSBA000A000000XX
				E6.2H-A/f 5000 Ekip Dip LSI	1SDA079319R1	ZEHKUSBB000A000000XX
				E6.2H-A/f 5000 Ekip Dip LSIG	1SDA079320R1	ZEHKUSBC000A000000XX
				E6.2H-A/f 5000 Ekip Touch LI	1SDA079321R1	ZEHKUSBD000A000000XX
				E6.2H-A/f 5000 Ekip Touch LSI	1SDA079322R1	ZEHKUSBE000A000000XX
				E6.2H-A/f 5000 Ekip Touch LSIG	1SDA079323R1	ZEHKUSBF000A000000XX
E6.2H-A/f 5000 Ekip Hi-Touch LSI				1SDA079325R1	ZEHKUSBJ200A000000XX	
E6.2H-A/f 5000 Ekip Hi-Touch LSIG				1SDA079326R1	ZEHKUSBK200A000000XX	
E6.2V-A/f	4000	100	100	E6.2V-A/f 4000 Ekip Dip LI	1SDA079368R1	ZEVJURBA000A000000XX
				E6.2V-A/f 4000 Ekip Dip LSI	1SDA079369R1	ZEVJURBB000A000000XX
				E6.2V-A/f 4000 Ekip Dip LSIG	1SDA079370R1	ZEVJURBC000A000000XX
				E6.2V-A/f 4000 Ekip Touch LI	1SDA079371R1	ZEVJURBD000A000000XX
				E6.2V-A/f 4000 Ekip Touch LSI	1SDA079372R1	ZEVJURBE000A000000XX
				E6.2V-A/f 4000 Ekip Touch LSIG	1SDA079373R1	ZEVJURBF000A000000XX
				E6.2V-A/f 4000 Ekip Hi-Touch LSI	1SDA079375R1	ZEVJURBJ200A000000XX
				E6.2V-A/f 4000 Ekip Hi-Touch LSIG	1SDA079376R1	ZEVJURBK200A000000XX
	5000	100	100	E6.2V-A/f 5000 Ekip Dip LI	1SDA079378R1	ZEVKUSBA000A000000XX
				E6.2V-A/f 5000 Ekip Dip LSI	1SDA079379R1	ZEVKUSBB000A000000XX
				E6.2V-A/f 5000 Ekip Dip LSIG	1SDA079380R1	ZEVKUSBC000A000000XX
				E6.2V-A/f 5000 Ekip Touch LI	1SDA079381R1	ZEVKUSBD000A000000XX
				E6.2V-A/f 5000 Ekip Touch LSI	1SDA079382R1	ZEVKUSBE000A000000XX
				E6.2V-A/f 5000 Ekip Touch LSIG	1SDA079383R1	ZEVKUSBF000A000000XX
E6.2V-A/f 5000 Ekip Hi-Touch LSI				1SDA079385R1	ZEVKUSBJ200A000000XX	
E6.2V-A/f 5000 Ekip Hi-Touch LSIG				1SDA079386R1	ZEVKUSBK200A000000XX	

SACE Emax 2 low voltage power circuit breakers

Automatic circuit breakers

Drawout version for power distribution



SACE Emax 2 E1.2B-A/N-A • Mobile part of drawout circuit breaker (MP)

Size	Frame Amps	Int. Rating (kA@508V)	Withstand (kA)	Type	3 Poles		4 Poles	
					Global PN	US / CA PN	Global PN	US / CA PN
E1.2B-A	800	42	42	E1.2B-A 800 Ekip Dip LI	1SDA077068R1	Z1BCUFAA000A000000XX	1SDA077148R1	ZABCUFAA000A000000XX
				E1.2B-A 800 Ekip Dip LSI	1SDA077069R1	Z1BCUFAB000A000000XX	1SDA077149R1	ZABCUFAB000A000000XX
				E1.2B-A 800 Ekip Dip LSIG	1SDA077070R1	Z1BCUFAC000A000000XX	1SDA077150R1	ZABCUFAC000A000000XX
				E1.2B-A 800 Ekip Touch LI	1SDA077071R1	Z1BCUFAD000A000000XX	1SDA077151R1	ZABCUFAD000A000000XX
				E1.2B-A 800 Ekip Touch LSI	1SDA077072R1	Z1BCUFAE000A000000XX	1SDA077152R1	ZABCUFAE000A000000XX
				E1.2B-A 800 Ekip Touch LSIG	1SDA077073R1	Z1BCUF AF000A000000XX	1SDA077153R1	ZABCUFAF000A000000XX
				E1.2B-A 800 Ekip Hi-Touch LSI	1SDA077075R1	Z1BCUFAJ200A000000XX	1SDA077155R1	ZABCUFAJ200A000000XX
	E1.2B-A 800 Ekip Hi-Touch LSIG	1SDA077076R1	Z1BCUFAK200A000000XX	1SDA077156R1	ZABCUFAK200A000000XX			
	1200	42	42	E1.2B-A 1200 Ekip Dip LI	1SDA077078R1	Z1BDUHAA000A000000XX	1SDA077158R1	ZABDUHAA000A000000XX
				E1.2B-A 1200 Ekip Dip LSI	1SDA077079R1	Z1BDUHAB000A000000XX	1SDA077159R1	ZABDUHAB000A000000XX
				E1.2B-A 1200 Ekip Dip LSIG	1SDA077080R1	Z1BDUHAC000A000000XX	1SDA077160R1	ZABDUHAC000A000000XX
				E1.2B-A 1200 Ekip Touch LI	1SDA077081R1	Z1BDUHAD000A000000XX	1SDA077161R1	ZABDUHAD000A000000XX
				E1.2B-A 1200 Ekip Touch LSI	1SDA077082R1	Z1BDUHAE000A000000XX	1SDA077162R1	ZABDUHAE000A000000XX
				E1.2B-A 1200 Ekip Touch LSIG	1SDA077083R1	Z1BDUHAF000A000000XX	1SDA077163R1	ZABDUHAF000A000000XX
E1.2B-A 1200 Ekip Hi-Touch LSI				1SDA077085R1	Z1BDUHAJ200A000000XX	1SDA077165R1	ZABDUHAJ200A000000XX	
E1.2B-A 1200 Ekip Hi-Touch LSIG	1SDA077086R1	Z1BDUHAK200A000000XX	1SDA077166R1	ZABDUHAK200A000000XX				
E1.2N-A	800	50	50	E1.2N-A 800 Ekip Dip LI	1SDA077088R1	Z1NCUFAA000A000000XX	1SDA077168R1	ZANCUFAA000A000000XX
				E1.2N-A 800 Ekip Dip LSI	1SDA077089R1	Z1NCUFAB000A000000XX	1SDA077169R1	ZANCUFAB000A000000XX
				E1.2N-A 800 Ekip Dip LSIG	1SDA077090R1	Z1NCUFAC000A000000XX	1SDA077170R1	ZANCUFAC000A000000XX
				E1.2N-A 800 Ekip Touch LI	1SDA077091R1	Z1NCUFAD000A000000XX	1SDA077171R1	ZANCUFAD000A000000XX
				E1.2N-A 800 Ekip Touch LSI	1SDA077092R1	Z1NCUFAE000A000000XX	1SDA077172R1	ZANCUFAE000A000000XX
				E1.2N-A 800 Ekip Touch LSIG	1SDA077093R1	Z1NCUF AF000A000000XX	1SDA077173R1	ZANCUFAF000A000000XX
				E1.2N-A 800 Ekip Hi-Touch LSI	1SDA077095R1	Z1NCUFAJ200A000000XX	1SDA077175R1	ZANCUFAJ200A000000XX
	E1.2N-A 800 Ekip Hi-Touch LSIG	1SDA077096R1	Z1NCUFAK200A000000XX	1SDA077176R1	ZANCUFAK200A000000XX			
	1200	50	50	E1.2N-A 1200 Ekip Dip LI	1SDA077098R1	Z1NDUHAA000A000000XX	1SDA077178R1	ZANDUHAA000A000000XX
				E1.2N-A 1200 Ekip Dip LSI	1SDA077099R1	Z1NDUHAB000A000000XX	1SDA077179R1	ZANDUHAB000A000000XX
				E1.2N-A 1200 Ekip Dip LSIG	1SDA077100R1	Z1NDUHAC000A000000XX	1SDA077180R1	ZANDUHAC000A000000XX
				E1.2N-A 1200 Ekip Touch LI	1SDA077101R1	Z1NDUHAD000A000000XX	1SDA077181R1	ZANDUHAD000A000000XX
				E1.2N-A 1200 Ekip Touch LSI	1SDA077102R1	Z1NDUHAE000A000000XX	1SDA077183R1	ZANDUHAE000A000000XX
				E1.2N-A 1200 Ekip Touch LSIG	1SDA077103R1	Z1NDUHAF000A000000XX	1SDA077182R1	ZANDUHAE000A000000XX
E1.2N-A 1200 Ekip Hi-Touch LSI				1SDA077105R1	Z1NDUHAJ200A000000XX	1SDA077185R1	ZANDUHAJ200A000000XX	
E1.2N-A 1200 Ekip Hi-Touch LSIG	1SDA077106R1	Z1NDUHAK200A000000XX	1SDA077186R1	ZANDUHAK200A000000XX				

SACE Emax 2 low voltage power circuit breakers

Automatic circuit breakers

Drawout version for power distribution



SACE Emax 2 E1.2S-A • Mobile part of drawout circuit breaker (MP)

Size	Frame Amps	Int. Rating (kA@508V)	Withstand (kA)	Type	3 Poles		4 Poles	
					Global PN	US / CA PN	Global PN	US / CA PN
E1.2S-A	250	65	50	E1.2S-A 250 Ekip Dip LI	1SDA077108R1	Z1SAUCA000A000000XX	1SDA077188R1	ZASAUCAA000A000000XX
				E1.2S-A 250 Ekip Dip LSI	1SDA077109R1	Z1SAUCAB000A000000XX	1SDA077189R1	ZASAU CAB000A000000XX
				E1.2S-A 250 Ekip Dip LSIG	1SDA077110R1	Z1SAUCAC000A000000XX	1SDA077190R1	ZASAU CAC000A000000XX
				E1.2S-A 250 Ekip Touch LI	1SDA077111R1	Z1SAUCAD000A000000XX	1SDA077191R1	ZASAU CAD000A000000XX
				E1.2S-A 250 Ekip Touch LSI	1SDA077112R1	Z1SAUCAE000A000000XX	1SDA077192R1	ZASAU CAE000A000000XX
				E1.2S-A 250 Ekip Touch LSIG	1SDA077113R1	Z1SAUCA F000A000000XX	1SDA077193R1	ZASAU CAF000A000000XX
				E1.2S-A 250 Ekip Hi-Touch LSI	1SDA077115R1	Z1SAUCAJ200A000000XX	1SDA077195R1	ZASAU CAJ200A000000XX
				E1.2S-A 250 Ekip Hi-Touch LSIG	1SDA077116R1	Z1SAUCAK200A000000XX	1SDA077196R1	ZASAU CAK200A000000XX
	400	65	50	E1.2S-A 400 Ekip Dip LI	1SDA077118R1	Z1SBUDAA000A000000XX	1SDA077198R1	ZASBUDAA000A000000XX
				E1.2S-A 400 Ekip Dip LSI	1SDA077119R1	Z1SBUDAB000A000000XX	1SDA077199R1	ZASBUDAB000A000000XX
				E1.2S-A 400 Ekip Dip LSIG	1SDA077120R1	Z1SBUDAC000A000000XX	1SDA077200R1	ZASBUDAC000A000000XX
				E1.2S-A 400 Ekip Touch LI	1SDA077121R1	Z1SBUDAD000A000000XX	1SDA077201R1	ZASBUDAD000A000000XX
				E1.2S-A 400 Ekip Touch LSI	1SDA077122R1	Z1SBUDAE000A000000XX	1SDA077202R1	ZASBUDAE000A000000XX
				E1.2S-A 400 Ekip Touch LSIG	1SDA077123R1	Z1SBUDAF000A000000XX	1SDA077203R1	ZASBUDAF000A000000XX
				E1.2S-A 400 Ekip Hi-Touch LSI	1SDA077125R1	Z1SBUDAJ200A000000XX	1SDA077205R1	ZASBUDAJ200A000000XX
				E1.2S-A 400 Ekip Hi-Touch LSIG	1SDA077126R1	Z1SBUDAK200A000000XX	1SDA077206R1	ZASBUDAK200A000000XX
	800	65	50	E1.2S-A 800 Ekip Dip LI	1SDA077128R1	Z1SCUFAA000A000000XX	1SDA077208R1	ZASCUFAA000A000000XX
				E1.2S-A 800 Ekip Dip LSI	1SDA077129R1	Z1SCUFAB000A000000XX	1SDA077209R1	ZASCUFAB000A000000XX
				E1.2S-A 800 Ekip Dip LSIG	1SDA077130R1	Z1SCUFAC000A000000XX	1SDA077210R1	ZASCUFAC000A000000XX
				E1.2S-A 800 Ekip Touch LI	1SDA077131R1	Z1SCUFAD000A000000XX	1SDA077211R1	ZASCUFAD000A000000XX
				E1.2S-A 800 Ekip Touch LSI	1SDA077132R1	Z1SCUFAE000A000000XX	1SDA077212R1	ZASCUFAE000A000000XX
				E1.2S-A 800 Ekip Touch LSIG	1SDA077133R1	Z1SCUF AF000A000000XX	1SDA077213R1	ZASCUFAF000A000000XX
				E1.2S-A 800 Ekip Hi-Touch LSI	1SDA077135R1	Z1SCUFAJ200A000000XX	1SDA077215R1	ZASCUFAJ200A000000XX
				E1.2S-A 800 Ekip Hi-Touch LSIG	1SDA077136R1	Z1SCUFAK200A000000XX	1SDA077216R1	ZASCUFAK200A000000XX
	1200	65	50	E1.2S-A 1200 Ekip Dip LI	1SDA077138R1	Z1SDUHAA000A000000XX	1SDA077218R1	ZASDUHAA000A000000XX
				E1.2S-A 1200 Ekip Dip LSI	1SDA077139R1	Z1SDUHAB000A000000XX	1SDA077219R1	ZASDUHAB000A000000XX
				E1.2S-A 1200 Ekip Dip LSIG	1SDA077140R1	Z1SDUHAC000A000000XX	1SDA077220R1	ZASDUHAC000A000000XX
				E1.2S-A 1200 Ekip Touch LI	1SDA077141R1	Z1SDUHAD000A000000XX	1SDA077221R1	ZASDUHAD000A000000XX
E1.2S-A 1200 Ekip Touch LSI				1SDA077142R1	Z1SDUHAE000A000000XX	1SDA077222R1	ZASDUHAE000A000000XX	
E1.2S-A 1200 Ekip Touch LSIG				1SDA077143R1	Z1SDUHAF000A000000XX	1SDA077223R1	ZASDUHAF000A000000XX	
E1.2S-A 1200 Ekip Hi-Touch LSI				1SDA077145R1	Z1SDUHAJ200A000000XX	1SDA077225R1	ZASDUHAJ200A000000XX	
E1.2S-A 1200 Ekip Hi-Touch LSIG				1SDA077146R1	Z1SDUHAK200A000000XX	1SDA077226R1	ZASDUHAK200A000000XX	

SACE Emax 2 low voltage power circuit breakers

Automatic circuit breakers

Drawout version for power distribution



SACE Emax 2 E2.2B-A/N-A • Mobile part of drawout circuit breaker (MP)

Size	Frame Amps	Int. Rating (kA@508V)	Withstand (kA)	Type	3 Poles		4 Poles	
					Global PN	US / CA PN	Global PN	US / CA PN
E2.2B-A	1600	42	42	E2.2B-A 1600 Ekip Dip LI	1SDA077568R1	Z2BEUJAA000A000000XX	1SDA077738R1	ZBBEUJAA000A000000XX
				E2.2B-A 1600 Ekip Dip LSI	1SDA077569R1	Z2BEUJAB000A000000XX	1SDA077739R1	ZBBEUJAB000A000000XX
				E2.2B-A 1600 Ekip Dip LSIG	1SDA077570R1	Z2BEUJAC000A000000XX	1SDA077740R1	ZBBEUJAC000A000000XX
				E2.2B-A 1600 Ekip Touch LI	1SDA077571R1	Z2BEUJAD000A000000XX	1SDA077741R1	ZBBEUJAD000A000000XX
				E2.2B-A 1600 Ekip Touch LSI	1SDA077572R1	Z2BEUJAE000A000000XX	1SDA077742R1	ZBBEUJAE000A000000XX
				E2.2B-A 1600 Ekip Touch LSIG	1SDA077573R1	Z2BEUJAF000A000000XX	1SDA077743R1	ZBBEUJAF000A000000XX
				E2.2B-A 1600 Ekip Hi-Touch LSI	1SDA077575R1	Z2BEUJAJ200A000000XX	1SDA077745R1	ZBBEUJAJ200A000000XX
				E2.2B-A 1600 Ekip Hi-Touch LSIG	1SDA077576R1	Z2BEUJAK200A000000XX	1SDA077746R1	ZBBEUJAK200A000000XX
E2.2N-A	1600	50	50	E2.2N-A 1600 Ekip Dip LI	1SDA077618R1	Z2NEUJAA000A000000XX	1SDA077788R1	ZBNEUJAA000A000000XX
				E2.2N-A 1600 Ekip Dip LSI	1SDA077619R1	Z2NEUJAB000A000000XX	1SDA077789R1	ZBNEUJAB000A000000XX
				E2.2N-A 1600 Ekip Dip LSIG	1SDA077620R1	Z2NEUJAC000A000000XX	1SDA077790R1	ZBNEUJAC000A000000XX
				E2.2N-A 1600 Ekip Touch LI	1SDA077621R1	Z2NEUJAD000A000000XX	1SDA077791R1	ZBNEUJAD000A000000XX
				E2.2N-A 1600 Ekip Touch LSI	1SDA077622R1	Z2NEUJAE000A000000XX	1SDA077792R1	ZBNEUJAE000A000000XX
				E2.2N-A 1600 Ekip Touch LSIG	1SDA077623R1	Z2NEUJAF000A000000XX	1SDA077793R1	ZBNEUJAF000A000000XX
				E2.2N-A 1600 Ekip Hi-Touch LSI	1SDA077625R1	Z2NEUJAJ200A000000XX	1SDA077795R1	ZBNEUJAJ200A000000XX
				E2.2N-A 1600 Ekip Hi-Touch LSIG	1SDA077626R1	Z2NEUJAK200A000000XX	1SDA077796R1	ZBNEUJAK200A000000XX
	2000	50	50	E2.2N-A 2000 Ekip Dip LI	1SDA077628R1	Z2NFUKAA000A000000XX	1SDA077798R1	ZBNFUKAA000A000000XX
				E2.2N-A 2000 Ekip Dip LSI	1SDA077629R1	Z2NFUKAB000A000000XX	1SDA077799R1	ZBNFUKAB000A000000XX
				E2.2N-A 2000 Ekip Dip LSIG	1SDA077630R1	Z2NFUKAC000A000000XX	1SDA077800R1	ZBNFUKAC000A000000XX
				E2.2N-A 2000 Ekip Touch LI	1SDA077631R1	Z2NFUKAD000A000000XX	1SDA077801R1	ZBNFUKAD000A000000XX
				E2.2N-A 2000 Ekip Touch LSI	1SDA077632R1	Z2NFUKAE000A000000XX	1SDA077802R1	ZBNFUKAE000A000000XX
				E2.2N-A 2000 Ekip Touch LSIG	1SDA077633R1	Z2NFUKAF000A000000XX	1SDA077803R1	ZBNFUKAF000A000000XX
				E2.2N-A 2000 Ekip Hi-Touch LSI	1SDA077635R1	Z2NFUKAJ200A000000XX	1SDA077805R1	ZBNFUKAJ200A000000XX
				E2.2N-A 2000 Ekip Hi-Touch LSIG	1SDA077636R1	Z2NFUKAK200A000000XX	1SDA077806R1	ZBNFUKAK200A000000XX

SACE Emax 2 low voltage power circuit breakers

Automatic circuit breakers

Drawout version for power distribution



SACE Emax 2 E2.2S-A - Mobile part of drawout circuit breaker (MP)

Size	Frame Amps	Int. Rating (kA@508V)	Withstand (kA)	Type	3 Poles		4 Poles	
					Global PN	US / CA PN	Global PN	US / CA PN
E2.2S-A	800	65	65	E2.2S-A 800 Ekip Dip LI	1SDA077638R1	Z2SCUFAA000A000000XX	1SDA077808R1	ZBSCUFAA000A000000XX
				E2.2S-A 800 Ekip Dip LSI	1SDA077639R1	Z2SCUFAB000A000000XX	1SDA077809R1	ZBSCUFAB000A000000XX
				E2.2S-A 800 Ekip Dip LSIG	1SDA077640R1	Z2SCUFAC000A000000XX	1SDA077810R1	ZBSCUFAC000A000000XX
				E2.2S-A 800 Ekip Touch LI	1SDA077641R1	Z2SCUFAD000A000000XX	1SDA077811R1	ZBSCUFAD000A000000XX
				E2.2S-A 800 Ekip Touch LSI	1SDA077642R1	Z2SCUFAE000A000000XX	1SDA077812R1	ZBSCUFAE000A000000XX
				E2.2S-A 800 Ekip Touch LSIG	1SDA077643R1	Z2SCUFAF000A000000XX	1SDA077813R1	ZBSCUFAF000A000000XX
				E2.2S-A 800 Ekip Hi-Touch LSI	1SDA077645R1	Z2SCUFAJ200A000000XX	1SDA077815R1	ZBSCUFAJ200A000000XX
				E2.2S-A 800 Ekip Hi-Touch LSIG	1SDA077646R1	Z2SCUFAK200A000000XX	1SDA077816R1	ZBSCUFAK200A000000XX
	1200	65	65	E2.2S-A 1200 Ekip Dip LI	1SDA077648R1	Z2SDUHAA000A000000XX	1SDA077818R1	ZBSDUHAA000A000000XX
				E2.2S-A 1200 Ekip Dip LSI	1SDA077649R1	Z2SDUHAB000A000000XX	1SDA077819R1	ZBSDUHAB000A000000XX
				E2.2S-A 1200 Ekip Dip LSIG	1SDA077650R1	Z2SDUHAC000A000000XX	1SDA077820R1	ZBSDUHAC000A000000XX
				E2.2S-A 1200 Ekip Touch LI	1SDA077651R1	Z2SDUHAD000A000000XX	1SDA077821R1	ZBSDUHAD000A000000XX
				E2.2S-A 1200 Ekip Touch LSI	1SDA077652R1	Z2SDUHAE000A000000XX	1SDA077822R1	ZBSDUHAE000A000000XX
				E2.2S-A 1200 Ekip Touch LSIG	1SDA077653R1	Z2SDUHAF000A000000XX	1SDA077823R1	ZBSDUHAF000A000000XX
				E2.2S-A 1200 Ekip Hi-Touch LSI	1SDA077655R1	Z2SDUHAJ200A000000XX	1SDA077825R1	ZBSDUHAJ200A000000XX
				E2.2S-A 1200 Ekip Hi-Touch LSIG	1SDA077656R1	Z2SDUHAK200A000000XX	1SDA077826R1	ZBSDUHAK200A000000XX
	1600	65	65	E2.2S-A 1600 Ekip Dip LI	1SDA077658R1	Z2SEUJAA000A000000XX	1SDA077828R1	ZBSEUJAA000A000000XX
				E2.2S-A 1600 Ekip Dip LSI	1SDA077659R1	Z2SEUJAB000A000000XX	1SDA077829R1	ZBSEUJAB000A000000XX
				E2.2S-A 1600 Ekip Dip LSIG	1SDA077660R1	Z2SEUJAC000A000000XX	1SDA077830R1	ZBSEUJAC000A000000XX
				E2.2S-A 1600 Ekip Touch LI	1SDA077661R1	Z2SEUJAD000A000000XX	1SDA077831R1	ZBSEUJAD000A000000XX
				E2.2S-A 1600 Ekip Touch LSI	1SDA077662R1	Z2SEUJAE000A000000XX	1SDA077832R1	ZBSEUJAE000A000000XX
				E2.2S-A 1600 Ekip Touch LSIG	1SDA077663R1	Z2SEUJAF000A000000XX	1SDA077833R1	ZBSEUJAF000A000000XX
				E2.2S-A 1600 Ekip Hi-Touch LSI	1SDA077665R1	Z2SEUJAJ200A000000XX	1SDA077835R1	ZBSEUJAJ200A000000XX
				E2.2S-A 1600 Ekip Hi-Touch LSIG	1SDA077666R1	Z2SEUJAK200A000000XX	1SDA077836R1	ZBSEUJAK200A000000XX
	2000	65	65	E2.2S-A 2000 Ekip Dip LI	1SDA077668R1	Z2SFUKAA000A000000XX	1SDA077838R1	ZBPFUKAA000A000000XX
				E2.2S-A 2000 Ekip Dip LSI	1SDA077669R1	Z2SFUKAB000A000000XX	1SDA077839R1	ZBPFUKAB000A000000XX
				E2.2S-A 2000 Ekip Dip LSIG	1SDA077670R1	Z2SFUKAC000A000000XX	1SDA077840R1	ZBPFUKAC000A000000XX
				E2.2S-A 2000 Ekip Touch LI	1SDA077671R1	Z2SFUKAD000A000000XX	1SDA077841R1	ZBPFUKAD000A000000XX
E2.2S-A 2000 Ekip Touch LSI				1SDA077672R1	Z2SFUKAE000A000000XX	1SDA077842R1	ZBPFUKAE000A000000XX	
E2.2S-A 2000 Ekip Touch LSIG				1SDA077673R1	Z2SFUKAF000A000000XX	1SDA077843R1	ZBPFUKAF000A000000XX	
E2.2S-A 2000 Ekip Hi-Touch LSI				1SDA077675R1	Z2SFUKAJ200A000000XX	1SDA077845R1	ZBPFUKAJ200A000000XX	
E2.2S-A 2000 Ekip Hi-Touch LSIG				1SDA077676R1	Z2SFUKAK200A000000XX	1SDA077846R1	ZBPFUKAK200A000000XX	

SACE Emax 2 low voltage power circuit breakers

Automatic circuit breakers

Drawout version for power distribution



SACE Emax 2 E2.2H-A • Mobile part of drawout circuit breaker (MP)

Size	Frame A amps	Int. Rating (kA@508V)	Withstand (kA)	Type	3 Poles		4 Poles	
					Global PN	US / CA PN	Global PN	US / CA PN
E2.2H-A	800	85	85	E2.2H-A 800 Ekip Dip LI	1SDA077578R1	Z2HCUFAA000A000000XX	1SDA077748R1	ZBHCUFAA000A000000XX
				E2.2H-A 800 Ekip Dip LSI	1SDA077579R1	Z2HCUFAB000A000000XX	1SDA077749R1	ZBHCUFAB000A000000XX
				E2.2H-A 800 Ekip Dip LSIG	1SDA077580R1	Z2HCUFAC000A000000XX	1SDA077750R1	ZBHCUFAC000A000000XX
				E2.2H-A 800 Ekip Touch LI	1SDA077581R1	Z2HCUFAD000A000000XX	1SDA077751R1	ZBHCUFAD000A000000XX
				E2.2H-A 800 Ekip Touch LSI	1SDA077582R1	Z2HCUFAE000A000000XX	1SDA077752R1	ZBHCUFAE000A000000XX
				E2.2H-A 800 Ekip Touch LSIG	1SDA077583R1	Z2HCUFAF000A000000XX	1SDA077753R1	ZBHCUFAF000A000000XX
				E2.2H-A 800 Ekip Hi-Touch LSI	1SDA077585R1	Z2HCUFAJ200A000000XX	1SDA077755R1	ZBHCUFAJ200A000000XX
	E2.2H-A 800 Ekip Hi-Touch LSIG	1SDA077586R1	Z2HCUFAK200A000000XX	1SDA077756R1	ZBHCUFAK200A000000XX			
	1200	85	85	E2.2H-A 1200 Ekip Dip LI	1SDA077588R1	Z2H DUHAA000A000000XX	1SDA077758R1	ZBHDUHAA000A000000XX
				E2.2H-A 1200 Ekip Dip LSI	1SDA077589R1	Z2H DUHAB000A000000XX	1SDA077759R1	ZBHDUHAB000A000000XX
				E2.2H-A 1200 Ekip Dip LSIG	1SDA077590R1	Z2H DUHAC000A000000XX	1SDA077760R1	ZBHDUHAC000A000000XX
				E2.2H-A 1200 Ekip Touch LI	1SDA077591R1	Z2H DUHAD000A000000XX	1SDA077761R1	ZBHDUHAD000A000000XX
				E2.2H-A 1200 Ekip Touch LSI	1SDA077592R1	Z2H DUHAE000A000000XX	1SDA077762R1	ZBHDUHA E000A000000XX
				E2.2H-A 1200 Ekip Touch LSIG	1SDA077593R1	Z2H DUHAF000A000000XX	1SDA077763R1	ZBHDUHAF000A000000XX
				E2.2H-A 1200 Ekip Hi-Touch LSI	1SDA077595R1	Z2H DUHAJ200A000000XX	1SDA077765R1	ZBHDUHAJ200A000000XX
	E2.2H-A 1200 Ekip Hi-Touch LSIG	1SDA077596R1	Z2H DUHAK200A000000XX	1SDA077766R1	ZBHDUHAK200A000000XX			
	1600	85	85	E2.2H-A 1600 Ekip Dip LI	1SDA077598R1	Z2HEUJAA000A000000XX	1SDA077768R1	ZBHEUJAA000A000000XX
				E2.2H-A 1600 Ekip Dip LSI	1SDA077599R1	Z2HEUJAB000A000000XX	1SDA077769R1	ZBHEUJAB000A000000XX
				E2.2H-A 1600 Ekip Dip LSIG	1SDA077600R1	Z2HEUJAC000A000000XX	1SDA077770R1	ZBHEUJAC000A000000XX
				E2.2H-A 1600 Ekip Touch LI	1SDA077601R1	Z2HEUJAD000A000000XX	1SDA077771R1	ZBHEUJAD000A000000XX
				E2.2H-A 1600 Ekip Touch LSI	1SDA077602R1	Z2HEUJAE000A000000XX	1SDA077772R1	ZBHEUJAE000A000000XX
				E2.2H-A 1600 Ekip Touch LSIG	1SDA077603R1	Z2HEUJAF000A000000XX	1SDA077773R1	ZBHEUJAF000A000000XX
				E2.2H-A 1600 Ekip Hi-Touch LSI	1SDA077605R1	Z2HEUJAJ200A000000XX	1SDA077775R1	ZBHEUJAJ200A000000XX
	E2.2H-A 1600 Ekip Hi-Touch LSIG	1SDA077606R1	Z2HEUJAK200A000000XX	1SDA077776R1	ZBHEUJAK200A000000XX			
	2000	85	85	E2.2H-A 2000 Ekip Dip LI	1SDA077608R1	Z2HFUKAA000A000000XX	1SDA077778R1	ZBHFUKAA000A000000XX
				E2.2H-A 2000 Ekip Dip LSI	1SDA077609R1	Z2HFUKAB000A000000XX	1SDA077779R1	ZBHFUKAB000A000000XX
				E2.2H-A 2000 Ekip Dip LSIG	1SDA077610R1	Z2HFUKAC000A000000XX	1SDA077780R1	ZBHFUKAC000A000000XX
				E2.2H-A 2000 Ekip Touch LI	1SDA077611R1	Z2HFUKAD000A000000XX	1SDA077781R1	ZBHFUKAD000A000000XX
E2.2H-A 2000 Ekip Touch LSI				1SDA077612R1	Z2HFUKAE000A000000XX	1SDA077782R1	ZBHFUKAE000A000000XX	
E2.2H-A 2000 Ekip Touch LSIG				1SDA077613R1	Z2HFUKAF000A000000XX	1SDA077783R1	ZBHFUKAF000A000000XX	
E2.2H-A 2000 Ekip Hi-Touch LSI				1SDA077615R1	Z2HFUKAJ200A000000XX	1SDA077785R1	ZBHFUKAJ200A000000XX	
E2.2H-A 2000 Ekip Hi-Touch LSIG	1SDA077616R1	Z2HFUKAK200A000000XX	1SDA077786R1	ZBHFUKAK200A000000XX				

SACE Emax 2 low voltage power circuit breakers

Automatic circuit breakers

Drawout version for power distribution



SACE Emax 2 E2.2V-A • Mobile part of drawout circuit breaker (MP)

Size	Frame Amps	Int. Rating (kA@50kV)	Withstand (kA)	Type	3 Poles		4 Poles	
					Global PN	US / CA PN	Global PN	US / CA PN
E2.2V-A	250	100	85	E2.2V-A 250 Ekip Dip LI	1SDA077678R1	Z2VAUCAA000A0000000XX	1SDA077848R1	ZBVAUCAA000A0000000XX
				E2.2V-A 250 Ekip Dip LSI	1SDA077679R1	Z2VAUCAB000A0000000XX	1SDA077849R1	ZBVAUCAB000A0000000XX
				E2.2V-A 250 Ekip Dip LSI SIG	1SDA077680R1	Z2VAUCAC000A0000000XX	1SDA077850R1	ZBVAUCAC000A0000000XX
				E2.2V-A 250 Ekip Touch LI	1SDA077681R1	Z2VAUCAD000A0000000XX	1SDA077851R1	ZBVAUCAD000A0000000XX
				E2.2V-A 250 Ekip Touch LSI	1SDA077682R1	Z2VAUCAE000A0000000XX	1SDA077852R1	ZBVAUCAE000A0000000XX
				E2.2V-A 250 Ekip Touch LSI SIG	1SDA077683R1	Z2VAUCAF000A0000000XX	1SDA077853R1	ZBVAUCAF000A0000000XX
				E2.2V-A 250 Ekip Hi-Touch LSI	1SDA077685R1	Z2VAUCAJ200A0000000XX	1SDA077855R1	ZBVAUCAJ200A0000000XX
	E2.2V-A 250 Ekip Hi-Touch LSI SIG	1SDA077686R1	Z2VAUCAK200A0000000XX	1SDA077856R1	ZBVAUCAK200A0000000XX			
	400	100	85	E2.2V-A 400 Ekip Dip LI	1SDA077688R1	Z2VBUDAA000A0000000XX	1SDA077858R1	ZBVBUDAA000A0000000XX
				E2.2V-A 400 Ekip Dip LSI	1SDA077689R1	Z2VBUDAB000A0000000XX	1SDA077859R1	ZBVBUDAB000A0000000XX
				E2.2V-A 400 Ekip Dip LSI SIG	1SDA077690R1	Z2VBUDAC000A0000000XX	1SDA077860R1	ZBVBUDAC000A0000000XX
				E2.2V-A 400 Ekip Touch LI	1SDA077691R1	Z2VBUDAD000A0000000XX	1SDA077861R1	ZBVBUDAD000A0000000XX
				E2.2V-A 400 Ekip Touch LSI	1SDA077692R1	Z2VBUDAE000A0000000XX	1SDA077862R1	ZBVBUDAE000A0000000XX
				E2.2V-A 400 Ekip Touch LSI SIG	1SDA077693R1	Z2VBUDAF000A0000000XX	1SDA077863R1	ZBVBUDAF000A0000000XX
				E2.2V-A 400 Ekip Hi-Touch LSI	1SDA077695R1	Z2VBUDAJ200A0000000XX	1SDA077865R1	ZBVBUDAJ200A0000000XX
	E2.2V-A 400 Ekip Hi-Touch LSI SIG	1SDA077696R1	Z2VBUDAK200A0000000XX	1SDA077866R1	ZBVBUDAK200A0000000XX			
	800	100	85	E2.2V-A 800 Ekip Dip LI	1SDA077698R1	Z2VCUFAA000A0000000XX	1SDA077868R1	ZBVCUFAA000A0000000XX
				E2.2V-A 800 Ekip Dip LSI	1SDA077699R1	Z2VCUFAB000A0000000XX	1SDA077869R1	ZBVCUFAB000A0000000XX
				E2.2V-A 800 Ekip Dip LSI SIG	1SDA077700R1	Z2VCUFAC000A0000000XX	1SDA077870R1	ZBVCUFAC000A0000000XX
				E2.2V-A 800 Ekip Touch LI	1SDA077701R1	Z2VCUFAD000A0000000XX	1SDA077871R1	ZBVCUFAD000A0000000XX
				E2.2V-A 800 Ekip Touch LSI	1SDA077702R1	Z2VCUFAE000A0000000XX	1SDA077872R1	ZBVCUFAE000A0000000XX
				E2.2V-A 800 Ekip Touch LSI SIG	1SDA077703R1	Z2VCUFAF000A0000000XX	1SDA077873R1	ZBVCUFAF000A0000000XX
				E2.2V-A 800 Ekip Hi-Touch LSI	1SDA077705R1	Z2VCUFAJ200A0000000XX	1SDA077875R1	ZBVCUFAJ200A0000000XX
	E2.2V-A 800 Ekip Hi-Touch LSI SIG	1SDA077706R1	Z2VCUFAK200A0000000XX	1SDA077876R1	ZBVCUFAK200A0000000XX			
	1200	100	85	E2.2V-A 1200 Ekip Dip LI	1SDA077708R1	Z2VDUHAA000A0000000XX	1SDA077878R1	ZBVDUHAA000A0000000XX
				E2.2V-A 1200 Ekip Dip LSI	1SDA077709R1	Z2VDUHAB000A0000000XX	1SDA077879R1	ZBVDUHAB000A0000000XX
				E2.2V-A 1200 Ekip Dip LSI SIG	1SDA077710R1	Z2VDUHAC000A0000000XX	1SDA077880R1	ZBVDUHAC000A0000000XX
				E2.2V-A 1200 Ekip Touch LI	1SDA077711R1	Z2VDUHAD000A0000000XX	1SDA077881R1	ZBVDUHAD000A0000000XX
				E2.2V-A 1200 Ekip Touch LSI	1SDA077712R1	Z2VDUHAE000A0000000XX	1SDA077882R1	ZBVDUHAE000A0000000XX
				E2.2V-A 1200 Ekip Touch LSI SIG	1SDA077713R1	Z2VDUHAF000A0000000XX	1SDA077883R1	ZBVDUHAF000A0000000XX
				E2.2V-A 1200 Ekip Hi-Touch LSI	1SDA077715R1	Z2VDUHAJ200A0000000XX	1SDA077885R1	ZBVDUHAJ200A0000000XX
	E2.2V-A 1200 Ekip Hi-Touch LSI SIG	1SDA077716R1	Z2VDUHAK200A0000000XX	1SDA077886R1	ZBVDUHAK200A0000000XX			
	1600	100	85	E2.2V-A 1600 Ekip Dip LI	1SDA077718R1	Z2VEUJAA000A0000000XX	1SDA077888R1	ZBVEUJAA000A0000000XX
				E2.2V-A 1600 Ekip Dip LSI	1SDA077719R1	Z2VEUJAB000A0000000XX	1SDA077889R1	ZBVEUJAB000A0000000XX
				E2.2V-A 1600 Ekip Dip LSI SIG	1SDA077720R1	Z2VEUJAC000A0000000XX	1SDA077890R1	ZBVEUJAC000A0000000XX
				E2.2V-A 1600 Ekip Touch LI	1SDA077721R1	Z2VEUJAD000A0000000XX	1SDA077891R1	ZBVEUJAD000A0000000XX
				E2.2V-A 1600 Ekip Touch LSI	1SDA077722R1	Z2VEUJAE000A0000000XX	1SDA077892R1	ZBVEUJAE000A0000000XX
				E2.2V-A 1600 Ekip Touch LSI SIG	1SDA077723R1	Z2VEUJAF000A0000000XX	1SDA077893R1	ZBVEUJAF000A0000000XX
				E2.2V-A 1600 Ekip Hi-Touch LSI	1SDA077725R1	Z2VEUJAJ200A0000000XX	1SDA077895R1	ZBVEUJAJ200A0000000XX
	E2.2V-A 1600 Ekip Hi-Touch LSI SIG	1SDA077726R1	Z2VEUJAK200A0000000XX	1SDA077896R1	ZBVEUJAK200A0000000XX			
	2000	100	85	E2.2V-A 2000 Ekip Dip LI	1SDA077728R1	Z2VFUKAA000A0000000XX	1SDA077898R1	ZBVFUKAA000A0000000XX
				E2.2V-A 2000 Ekip Dip LSI	1SDA077729R1	Z2VFUKAB000A0000000XX	1SDA077899R1	ZBVFUKAB000A0000000XX
E2.2V-A 2000 Ekip Dip LSI SIG				1SDA077730R1	Z2VFUKAC000A0000000XX	1SDA077900R1	ZBVFUKAC000A0000000XX	
E2.2V-A 2000 Ekip Touch LI				1SDA077731R1	Z2VFUKAD000A0000000XX	1SDA077901R1	ZBVFUKAD000A0000000XX	
E2.2V-A 2000 Ekip Touch LSI				1SDA077732R1	Z2VFUKAE000A0000000XX	1SDA077902R1	ZBVFUKAE000A0000000XX	
E2.2V-A 2000 Ekip Touch LSI SIG				1SDA077733R1	Z2VFUKAF000A0000000XX	1SDA077903R1	ZBVFUKAF000A0000000XX	
E2.2V-A 2000 Ekip Hi-Touch LSI				1SDA077735R1	Z2VFUKAJ200A0000000XX	1SDA077905R1	ZBVFUKAJ200A0000000XX	
E2.2V-A 2000 Ekip Hi-Touch LSI SIG	1SDA077736R1	Z2VFUKAK200A0000000XX	1SDA077906R1	ZBVFUKAK200A0000000XX				

SACE Emax 2 low voltage power circuit breakers

Automatic circuit breakers

Drawout version for power distribution



SACE Emax 2 E4.2S-A/H-A • Mobile part of drawout circuit breaker (MP)

Size	Frame Amps	Int. Rating (kA@508V)	Withstand (kA)	Type	3 Poles		4 Poles	
					Global PN	US / CA PN	Global PN	US / CA PN
E4.2S-A	2500	65	65	E4.2S-A 2500 Ekip Dip LI	1SDA078458R1	Z4SGULAA000A000000XX	1SDA078688R1	ZCSGULAA000A000000XX
				E4.2S-A 2500 Ekip Dip LSI	1SDA078459R1	Z4SGULAB000A000000XX	1SDA078689R1	ZCSGULAB000A000000XX
				E4.2S-A 2500 Ekip Dip LSIG	1SDA078460R1	Z4SGULAC000A000000XX	1SDA078690R1	ZCSGULAC000A000000XX
				E4.2S-A 2500 Ekip Touch LI	1SDA078461R1	Z4SGULAD000A000000XX	1SDA078691R1	ZCSGULAD000A000000XX
				E4.2S-A 2500 Ekip Touch LSI	1SDA078462R1	Z4SGULAE000A000000XX	1SDA078692R1	ZCSGULAE000A000000XX
				E4.2S-A 2500 Ekip Touch LSIG	1SDA078463R1	Z4SGULAF000A000000XX	1SDA078693R1	ZCSGULAF000A000000XX
				E4.2S-A 2500 Ekip Hi-Touch LSI	1SDA078465R1	Z4SGULAJ200A000000XX	1SDA078695R1	ZCSGULAJ200A000000XX
				E4.2S-A 2500 Ekip Hi-Touch LSIG	1SDA078466R1	Z4SGULAK200A000000XX	1SDA078696R1	ZCSGULAK200A000000XX
	3200	65	65	E4.2S-A 3200 Ekip Dip LI	1SDA078468R1	Z4SHUNAA000A000000XX	1SDA078698R1	ZCSHUNAA000A000000XX
				E4.2S-A 3200 Ekip Dip LSI	1SDA078469R1	Z4SHUNAB000A000000XX	1SDA078699R1	ZCSHUNAB000A000000XX
				E4.2S-A 3200 Ekip Dip LSIG	1SDA078470R1	Z4SHUNAC000A000000XX	1SDA078700R1	ZCSHUNAC000A000000XX
				E4.2S-A 3200 Ekip Touch LI	1SDA078471R1	Z4SHUNAD000A000000XX	1SDA078701R1	ZCSHUNAD000A000000XX
				E4.2S-A 3200 Ekip Touch LSI	1SDA078472R1	Z4SHUNAE000A000000XX	1SDA078702R1	ZCSHUNAE000A000000XX
				E4.2S-A 3200 Ekip Touch LSIG	1SDA078473R1	Z4SHUNAF000A000000XX	1SDA078703R1	ZCSHUNAF000A000000XX
E4.2S-A 3200 Ekip Hi-Touch LSI				1SDA078475R1	Z4SHUNAJ200A000000XX	1SDA078705R1	ZCSHUNAJ200A000000XX	
E4.2S-A 3200 Ekip Hi-Touch LSIG				1SDA078476R1	Z4SHUNAK200A000000XX	1SDA078706R1	ZCSHUNAK200A000000XX	
E4.2H-A	2500	85	85	E4.2H-A 2500 Ekip Dip LI	1SDA078368R1	Z4HGULAA000A000000XX	1SDA078598R1	ZCHGULAA000A000000XX
				E4.2H-A 2500 Ekip Dip LSI	1SDA078369R1	Z4HGULAB000A000000XX	1SDA078599R1	ZCHGULAB000A000000XX
				E4.2H-A 2500 Ekip Dip LSIG	1SDA078370R1	Z4HGULAC000A000000XX	1SDA078600R1	ZCHGULAC000A000000XX
				E4.2H-A 2500 Ekip Touch LI	1SDA078371R1	Z4HGULAD000A000000XX	1SDA078601R1	ZCHGULAD000A000000XX
				E4.2H-A 2500 Ekip Touch LSI	1SDA078372R1	Z4HGULAE000A000000XX	1SDA078602R1	ZCHGULAE000A000000XX
				E4.2H-A 2500 Ekip Touch LSIG	1SDA078373R1	Z4HGULAF000A000000XX	1SDA078603R1	ZCHGULAF000A000000XX
				E4.2H-A 2500 Ekip Hi-Touch LSI	1SDA078375R1	Z4HGULAJ200A000000XX	1SDA078605R1	ZCHGULAJ200A000000XX
				E4.2H-A 2500 Ekip Hi-Touch LSIG	1SDA078376R1	Z4HGULAK200A000000XX	1SDA078606R1	ZCHGULAK200A000000XX
	3200	85	85	E4.2H-A 3200 Ekip Dip LI	1SDA078378R1	Z4HHUNAA000A000000XX	1SDA078608R1	ZCHHUNAA000A000000XX
				E4.2H-A 3200 Ekip Dip LSI	1SDA078379R1	Z4HHUNAB000A000000XX	1SDA078609R1	ZCHHUNAB000A000000XX
				E4.2H-A 3200 Ekip Dip LSIG	1SDA078380R1	Z4HHUNAC000A000000XX	1SDA078610R1	ZCHHUNAC000A000000XX
				E4.2H-A 3200 Ekip Touch LI	1SDA078381R1	Z4HHUNAD000A000000XX	1SDA078611R1	ZCHHUNAD000A000000XX
				E4.2H-A 3200 Ekip Touch LSI	1SDA078382R1	Z4HHUNAE000A000000XX	1SDA078612R1	ZCHHUNAE000A000000XX
				E4.2H-A 3200 Ekip Touch LSIG	1SDA078383R1	Z4HHUNAF000A000000XX	1SDA078613R1	ZCHHUNAF000A000000XX
E4.2H-A 3200 Ekip Hi-Touch LSI				1SDA078385R1	Z4HHUNAJ200A000000XX	1SDA078615R1	ZCHHUNAJ200A000000XX	
E4.2H-A 3200 Ekip Hi-Touch LSIG				1SDA078386R1	Z4HHUNAK200A000000XX	1SDA078616R1	ZCHHUNAK200A000000XX	

SACE Emax 2 low voltage power circuit breakers

Automatic circuit breakers

Drawout version for power distribution



SACE Emax 2 E4.2V-A • Mobile part of drawout circuit breaker (MP)

Size	Frame Amps	Int. Rating (kA@508V)	Withstand (kA)	Type	3 Poles		4 Poles	
					Global PN	US / CA PN	Global PN	US / CA PN
E4.2V-A	800	100	85	E4.2V-A 800 Ekip Dip LI	1SDA078488R1	Z4VCUFAA000A000000XX	1SDA078718R1	ZCVCUFAA000A000000XX
				E4.2V-A 800 Ekip Dip LSI	1SDA078489R1	Z4VCUFAB000A000000XX	1SDA078719R1	ZCVCUFAB000A000000XX
				E4.2V-A 800 Ekip Dip LSIg	1SDA078490R1	Z4VCUFAC000A000000XX	1SDA078720R1	ZCVCUFAC000A000000XX
				E4.2V-A 800 Ekip Touch LI	1SDA078491R1	Z4VCUFAD000A000000XX	1SDA078721R1	ZCVCUFAD000A000000XX
				E4.2V-A 800 Ekip Touch LSI	1SDA078492R1	Z4VCUFAE000A000000XX	1SDA078722R1	ZCVCUFAE000A000000XX
				E4.2V-A 800 Ekip Touch LSIg	1SDA078493R1	Z4VCUF AF000A000000XX	1SDA078723R1	ZCVCUFAF000A000000XX
				E4.2V-A 800 Ekip Hi-Touch LSI	1SDA078495R1	Z4VCUFAJ200A000000XX	1SDA078725R1	ZCVCUFAJ200A000000XX
				E4.2V-A 800 Ekip Hi-Touch LSIg	1SDA078496R1	Z4VCUFAK200A000000XX	1SDA078726R1	ZCVCUFAK200A000000XX
E4.2V-A	1600	100	85	E4.2V-A 1600 Ekip Dip LI	1SDA078498R1	Z4VEUJAA000A000000XX	1SDA078728R1	ZCVEUJAA000A000000XX
				E4.2V-A 1600 Ekip Dip LSI	1SDA078499R1	Z4VEUJAB000A000000XX	1SDA078729R1	ZCVEUJAB000A000000XX
				E4.2V-A 1600 Ekip Dip LSIg	1SDA078500R1	Z4VEUJAC000A000000XX	1SDA078730R1	ZCVEUJAC000A000000XX
				E4.2V-A 1600 Ekip Touch LI	1SDA078501R1	Z4VEUJAD000A000000XX	1SDA078731R1	ZCVEUJAD000A000000XX
				E4.2V-A 1600 Ekip Touch LSI	1SDA078502R1	Z4VEUJAE000A000000XX	1SDA078732R1	ZCVEUJAE000A000000XX
				E4.2V-A 1600 Ekip Touch LSIg	1SDA078503R1	Z4VEUJAF000A000000XX	1SDA078733R1	ZCVEUJAF000A000000XX
				E4.2V-A 1600 Ekip Hi-Touch LSI	1SDA078505R1	Z4VEUJAJ200A000000XX	1SDA078735R1	ZCVEUJAJ200A000000XX
				E4.2V-A 1600 Ekip Hi-Touch LSIg	1SDA078506R1	Z4VEUJAK200A000000XX	1SDA078736R1	ZCVEUJAK200A000000XX
E4.2V-A	2000	100	85	E4.2V-A 2000 Ekip Dip LI	1SDA078508R1	Z4VFUKAA000A000000XX	1SDA078738R1	ZCVFUKAA000A000000XX
				E4.2V-A 2000 Ekip Dip LSI	1SDA078509R1	Z4VFUKAB000A000000XX	1SDA078739R1	ZCVFUKAB000A000000XX
				E4.2V-A 2000 Ekip Dip LSIg	1SDA078510R1	Z4VFUKAC000A000000XX	1SDA078740R1	ZCVFUKAC000A000000XX
				E4.2V-A 2000 Ekip Touch LI	1SDA078511R1	Z4VFUKAD000A000000XX	1SDA078741R1	ZCVFUKAD000A000000XX
				E4.2V-A 2000 Ekip Touch LSI	1SDA078512R1	Z4VFUKAE000A000000XX	1SDA078742R1	ZCVFUKAE000A000000XX
				E4.2V-A 2000 Ekip Touch LSIg	1SDA078513R1	Z4VFUKAF000A000000XX	1SDA078743R1	ZCVFUKAF000A000000XX
				E4.2V-A 2000 Ekip Hi-Touch LSI	1SDA078515R1	Z4VFUKAJ200A000000XX	1SDA078745R1	ZCVFUKAJ200A000000XX
				E4.2V-A 2000 Ekip Hi-Touch LSIg	1SDA078516R1	Z4VFUKAK200A000000XX	1SDA078746R1	ZCVFUKAK200A000000XX
E4.2V-A	2500	100	85	E4.2V-A 2500 Ekip Dip LI	1SDA078518R1	Z4VGULAA000A000000XX	1SDA078748R1	ZCVGULAA000A000000XX
				E4.2V-A 2500 Ekip Dip LSI	1SDA078519R1	Z4VGULAB000A000000XX	1SDA078749R1	ZCVGULAB000A000000XX
				E4.2V-A 2500 Ekip Dip LSIg	1SDA078520R1	Z4VGULAC000A000000XX	1SDA078750R1	ZCVGULAC000A000000XX
				E4.2V-A 2500 Ekip Touch LI	1SDA078521R1	Z4VGULAD000A000000XX	1SDA078751R1	ZCVGULAD000A000000XX
				E4.2V-A 2500 Ekip Touch LSI	1SDA078522R1	Z4VGULAE000A000000XX	1SDA078752R1	ZCVGULAE000A000000XX
				E4.2V-A 2500 Ekip Touch LSIg	1SDA078523R1	Z4VGULAF000A000000XX	1SDA078753R1	ZCVGULAF000A000000XX
				E4.2V-A 2500 Ekip Hi-Touch LSI	1SDA078525R1	Z4VGULAJ200A000000XX	1SDA078755R1	ZCVGULAJ200A000000XX
				E4.2V-A 2500 Ekip Hi-Touch LSIg	1SDA078526R1	Z4VGULAK200A000000XX	1SDA078756R1	ZCVGULAK200A000000XX
E4.2V-A	3200	100	85	E4.2V-A 3200 Ekip Dip LI	1SDA078528R1	Z4VHUNAA000A000000XX	1SDA078758R1	ZCVHUNAA000A000000XX
				E4.2V-A 3200 Ekip Dip LSI	1SDA078529R1	Z4VHUNAB000A000000XX	1SDA078759R1	ZCVHUNAB000A000000XX
				E4.2V-A 3200 Ekip Dip LSIg	1SDA078530R1	Z4VHUNAC000A000000XX	1SDA078760R1	ZCVHUNAC000A000000XX
				E4.2V-A 3200 Ekip Touch LI	1SDA078531R1	Z4VHUNAD000A000000XX	1SDA078761R1	ZCVHUNAD000A000000XX
				E4.2V-A 3200 Ekip Touch LSI	1SDA078532R1	Z4VHUNAE000A000000XX	1SDA078762R1	ZCVHUNAE000A000000XX
				E4.2V-A 3200 Ekip Touch LSIg	1SDA078533R1	Z4VHUNAF000A000000XX	1SDA078763R1	ZCVHUNAF000A000000XX
				E4.2V-A 3200 Ekip Hi-Touch LSI	1SDA078535R1	Z4VHUNAJ200A000000XX	1SDA078765R1	ZCVHUNAJ200A000000XX
				E4.2V-A 3200 Ekip Hi-Touch LSIg	1SDA078536R1	Z4VHUNAK200A000000XX	1SDA078766R1	ZCVHUNAK200A000000XX

SACE Emax 2 low voltage power circuit breakers

Automatic circuit breakers

Drawout version for power distribution



SACE Emax 2 E6.2H-A/V-A • Mobile part of drawout circuit breaker (MP)

Size	Frame Amps	Int. Rating (kA@508V)	Withstand (kA)	Type	3 Poles		4 Poles	
					Global PN	US / CA PN	Global PN	US / CA PN
E6.2H-A	4000	85	85	E6.2H-A 4000 Ekip Dip LI	1SDA079068R1	Z6HJURAA000A000000XX	1SDA079188R1	ZDHJURAA000A000000XX
				E6.2H-A 4000 Ekip Dip LSI	1SDA079069R1	Z6HJURAB000A000000XX	1SDA079189R1	ZDHJURAB000A000000XX
				E6.2H-A 4000 Ekip Dip LSIG	1SDA079070R1	Z6HJURAC000A000000XX	1SDA079190R1	ZDHJURAC000A000000XX
				E6.2H-A 4000 Ekip Touch LI	1SDA079071R1	Z6HJURAD000A000000XX	1SDA079191R1	ZDHJURAD000A000000XX
				E6.2H-A 4000 Ekip Touch LSI	1SDA079072R1	Z6HJURAE000A000000XX	1SDA079192R1	ZDHJURAE000A000000XX
				E6.2H-A 4000 Ekip Touch LSIG	1SDA079073R1	Z6HJURAF000A000000XX	1SDA079193R1	ZDHJURAF000A000000XX
				E6.2H-A 4000 Ekip Hi-Touch LSI	1SDA079075R1	Z6HJURAJ200A000000XX	1SDA079195R1	ZDHJURAJ200A000000XX
	E6.2H-A 4000 Ekip Hi-Touch LSIG	1SDA079076R1	Z6HJURAK200A000000XX	1SDA079196R1	ZDHJURAK200A000000XX			
	5000	85	85	E6.2H-A 5000 Ekip Dip LI	1SDA079078R1	Z6HKUSAA000A000000XX	1SDA079198R1	ZDHKUSAA000A000000XX
				E6.2H-A 5000 Ekip Dip LSI	1SDA079079R1	Z6HKUSAB000A000000XX	1SDA079199R1	ZDHKUSAB000A000000XX
				E6.2H-A 5000 Ekip Dip LSIG	1SDA079080R1	Z6HKUSAC000A000000XX	1SDA079200R1	ZDHKUSAC000A000000XX
				E6.2H-A 5000 Ekip Touch LI	1SDA079081R1	Z6HKUSAD000A000000XX	1SDA079201R1	ZDHKUSAD000A000000XX
				E6.2H-A 5000 Ekip Touch LSI	1SDA079082R1	Z6HKUSAE000A000000XX	1SDA079202R1	ZDHKUSAE000A000000XX
				E6.2H-A 5000 Ekip Touch LSIG	1SDA079083R1	Z6HKUSAF000A000000XX	1SDA079203R1	ZDHKUSAF000A000000XX
				E6.2H-A 5000 Ekip Hi-Touch LSI	1SDA079085R1	Z6HKUSAJ200A000000XX	1SDA079205R1	ZDHKUSAJ200A000000XX
	E6.2H-A 5000 Ekip Hi-Touch LSIG	1SDA079086R1	Z6HKUSAK200A000000XX	1SDA079206R1	ZDHKUSAK200A000000XX			
	6000	85	85	E6.2H-A 6000 Ekip Dip LI	1SDA079088R1	Z6HLUTAA000A000000XX	-	-
				E6.2H-A 6000 Ekip Dip LSI	1SDA079089R1	Z6HLUTAB000A000000XX	-	-
				E6.2H-A 6000 Ekip Dip LSIG	1SDA079090R1	Z6HLUTAC000A000000XX	-	-
				E6.2H-A 6000 Ekip Touch LI	1SDA079091R1	Z6HLUTAD000A000000XX	-	-
				E6.2H-A 6000 Ekip Touch LSI	1SDA079092R1	Z6HLUTAE000A000000XX	-	-
				E6.2H-A 6000 Ekip Touch LSIG	1SDA079093R1	Z6HLUTAF000A000000XX	-	-
				E6.2H-A 6000 Ekip Hi-Touch LSI	1SDA079095R1	Z6HLUTAJ200A000000XX	-	-
	E6.2H-A 6000 Ekip Hi-Touch LSIG	1SDA079096R1	Z6HLUTAK200A000000XX	-	-			
E6.2V-A	4000	100	100	E6.2V-A 4000 Ekip Dip LI	1SDA079128R1	Z6VJURAA000A000000XX	1SDA079248R1	ZDVJURAA000A000000XX
				E6.2V-A 4000 Ekip Dip LSI	1SDA079129R1	Z6VJURAB000A000000XX	1SDA079249R1	ZDVJURAB000A000000XX
				E6.2V-A 4000 Ekip Dip LSIG	1SDA079130R1	Z6VJURAC000A000000XX	1SDA079250R1	ZDVJURAC000A000000XX
				E6.2V-A 4000 Ekip Touch LI	1SDA079131R1	Z6VJURAD000A000000XX	1SDA079251R1	ZDVJURAD000A000000XX
				E6.2V-A 4000 Ekip Touch LSI	1SDA079132R1	Z6VJURAE000A000000XX	1SDA079252R1	ZDVJURAE000A000000XX
				E6.2V-A 4000 Ekip Touch LSIG	1SDA079133R1	Z6VJURAF000A000000XX	1SDA079253R1	ZDVJURAF000A000000XX
				E6.2V-A 4000 Ekip Hi-Touch LSI	1SDA079135R1	Z6VJURAJ200A000000XX	1SDA079255R1	ZDVJURAJ200A000000XX
	E6.2V-A 4000 Ekip Hi-Touch LSIG	1SDA079136R1	Z6VJURAK200A000000XX	1SDA079256R1	ZDVJURAK200A000000XX			
	5000	100	100	E6.2V-A 5000 Ekip Dip LI	1SDA079138R1	Z6VKUSAA000A000000XX	1SDA079258R1	ZDVKUSAA000A000000XX
				E6.2V-A 5000 Ekip Dip LSI	1SDA079139R1	Z6VKUSAB000A000000XX	1SDA079259R1	ZDVKUSAB000A000000XX
				E6.2V-A 5000 Ekip Dip LSIG	1SDA079140R1	Z6VKUSAC000A000000XX	1SDA079260R1	ZDVKUSAC000A000000XX
				E6.2V-A 5000 Ekip Touch LI	1SDA079141R1	Z6VKUSAD000A000000XX	1SDA079261R1	ZDVKUSAD000A000000XX
				E6.2V-A 5000 Ekip Touch LSI	1SDA079142R1	Z6VKUSAE000A000000XX	1SDA079262R1	ZDVKUSAE000A000000XX
				E6.2V-A 5000 Ekip Touch LSIG	1SDA079143R1	Z6VKUSAF000A000000XX	1SDA079263R1	ZDVKUSAF000A000000XX
				E6.2V-A 5000 Ekip Hi-Touch LSI	1SDA079145R1	Z6VKUSAJ200A000000XX	1SDA079265R1	ZDVKUSAJ200A000000XX
	E6.2V-A 5000 Ekip Hi-Touch LSIG	1SDA079146R1	Z6VKUSAK200A000000XX	1SDA079266R1	ZDVKUSAK200A000000XX			
	6000	100	100	E6.2V-A 6000 Ekip Dip LI	1SDA079148R1	Z6VLUTAA000A000000XX	1SDA079268R1	-
				E6.2V-A 6000 Ekip Dip LSI	1SDA079149R1	Z6VLUTAB000A000000XX	1SDA079269R1	-
				E6.2V-A 6000 Ekip Dip LSIG	1SDA079150R1	Z6VLUTAC000A000000XX	1SDA079270R1	-
				E6.2V-A 6000 Ekip Touch LI	1SDA079151R1	Z6VLUTAD000A000000XX	1SDA079271R1	-
				E6.2V-A 6000 Ekip Touch LSI	1SDA079152R1	Z6VLUTAE000A000000XX	1SDA079272R1	-
				E6.2V-A 6000 Ekip Touch LSIG	1SDA079153R1	Z6VLUTAF000A000000XX	1SDA079273R1	-
				E6.2V-A 6000 Ekip Hi-Touch LSI	1SDA079155R1	Z6VLUTAJ200A000000XX	1SDA079275R1	-
	E6.2V-A 6000 Ekip Hi-Touch LSIG	1SDA079156R1	Z6VLUTAK200A000000XX	1SDA079276R1	-			

SACE Emax 2 low voltage power circuit breakers

Automatic circuit breakers

Drawout version for power distribution



SACE Emax 2 E6.2H-A/f/V-A/f • Mobile part of drawout circuit breaker (MP)

Size	Frame Amps	Int. Rating (kA@508V)	Withstand (kA)	Type	4 Poles	
					Global PN	US / CA PN
E6.2H-A/f	4000	85	85	E6.2H-A/f 4000 Ekip Dip LI	1SDA079428R1	ZEHJURAA000A000000XX
				E6.2H-A/f 4000 Ekip Dip LSI	1SDA079429R1	ZEHJURAB000A000000XX
				E6.2H-A/f 4000 Ekip Dip LSIG	1SDA079430R1	ZEHJURAC000A000000XX
				E6.2H-A/f 4000 Ekip Touch LI	1SDA079431R1	ZEHJURAD000A000000XX
				E6.2H-A/f 4000 Ekip Touch LSI	1SDA079432R1	ZEHJURAE000A000000XX
				E6.2H-A/f 4000 Ekip Touch LSIG	1SDA079433R1	ZEHJURAF000A000000XX
				E6.2H-A/f 4000 Ekip Hi-Touch LSI	1SDA079435R1	ZEHJURAJ200A000000XX
				E6.2H-A/f 4000 Ekip Hi-Touch LSIG	1SDA079436R1	ZEHJURAK200A000000XX
	5000	85	85	E6.2H-A/f 5000 Ekip Dip LI	1SDA079438R1	ZEHKUSAA000A000000XX
				E6.2H-A/f 5000 Ekip Dip LSI	1SDA079439R1	ZEHKUSAB000A000000XX
				E6.2H-A/f 5000 Ekip Dip LSIG	1SDA079440R1	ZEHKUSAC000A000000XX
				E6.2H-A/f 5000 Ekip Touch LI	1SDA079441R1	ZEHKUSAD000A000000XX
				E6.2H-A/f 5000 Ekip Touch LSI	1SDA079442R1	ZEHKUSAE000A000000XX
				E6.2H-A/f 5000 Ekip Touch LSIG	1SDA079443R1	ZEHKUSAF000A000000XX
				E6.2H-A/f 5000 Ekip Hi-Touch LSI	1SDA079445R1	ZEHKUSAJ200A000000XX
				E6.2H-A/f 5000 Ekip Hi-Touch LSIG	1SDA079446R1	ZEHKUSAK200A000000XX
	6000	85	85	E6.2H-A/f 6000 Ekip Dip LI	1SDA079448R1	ZEHLUTAA000A000000XX
				E6.2H-A/f 6000 Ekip Dip LSI	1SDA079449R1	ZEHLUTAB000A000000XX
				E6.2H-A/f 6000 Ekip Dip LSIG	1SDA079450R1	ZEHLUTAC000A000000XX
				E6.2H-A/f 6000 Ekip Touch LI	1SDA079451R1	ZEHLUTAD000A000000XX
				E6.2H-A/f 6000 Ekip Touch LSI	1SDA079452R1	ZEHLUTAE000A000000XX
				E6.2H-A/f 6000 Ekip Touch LSIG	1SDA079453R1	ZEHLUTAF000A000000XX
				E6.2H-A/f 6000 Ekip Hi-Touch LSI	1SDA079455R1	ZEHLUTAJ200A000000XX
				E6.2H-A/f 6000 Ekip Hi-Touch LSIG	1SDA079456R1	ZEHLUTAK200A000000XX
E6.2V-A/f	4000	100	100	E6.2V-A/f 4000 Ekip Dip LI	1SDA079488R1	ZEVJURAA000A000000XX
				E6.2V-A/f 4000 Ekip Dip LSI	1SDA079489R1	ZEVJURAB000A000000XX
				E6.2V-A/f 4000 Ekip Dip LSIG	1SDA079490R1	ZEVJURAC000A000000XX
				E6.2V-A/f 4000 Ekip Touch LI	1SDA079491R1	ZEVJURAD000A000000XX
				E6.2V-A/f 4000 Ekip Touch LSI	1SDA079492R1	ZEVJURAE000A000000XX
				E6.2V-A/f 4000 Ekip Touch LSIG	1SDA079493R1	ZEVJURAF000A000000XX
				E6.2V-A/f 4000 Ekip Hi-Touch LSI	1SDA079495R1	ZEVJURAJ200A000000XX
				E6.2V-A/f 4000 Ekip Hi-Touch LSIG	1SDA079496R1	ZEVJURAK200A000000XX
	5000	100	100	E6.2V-A/f 5000 Ekip Dip LI	1SDA079498R1	ZEVKUSAA000A000000XX
				E6.2V-A/f 5000 Ekip Dip LSI	1SDA079499R1	ZEVKUSAB000A000000XX
				E6.2V-A/f 5000 Ekip Dip LSIG	1SDA079500R1	ZEVKUSAC000A000000XX
				E6.2V-A/f 5000 Ekip Touch LI	1SDA079501R1	ZEVKUSAD000A000000XX
				E6.2V-A/f 5000 Ekip Touch LSI	1SDA079502R1	ZEVKUSAE000A000000XX
				E6.2V-A/f 5000 Ekip Touch LSIG	1SDA079503R1	ZEVKUSAF000A000000XX
				E6.2V-A/f 5000 Ekip Hi-Touch LSI	1SDA079505R1	ZEVKUSAJ200A000000XX
				E6.2V-A/f 5000 Ekip Hi-Touch LSIG	1SDA079506R1	ZEVKUSAK200A000000XX
	6000	100	100	E6.2V-A/f 6000 Ekip Dip LI	1SDA079508R1	-
				E6.2V-A/f 6000 Ekip Dip LSI	1SDA079509R1	-
				E6.2V-A/f 6000 Ekip Dip LSIG	1SDA079510R1	-
				E6.2V-A/f 6000 Ekip Touch LI	1SDA079511R1	-
				E6.2V-A/f 6000 Ekip Touch LSI	1SDA079512R1	-
				E6.2V-A/f 6000 Ekip Touch LSIG	1SDA079513R1	-
				E6.2V-A/f 6000 Ekip Hi-Touch LSI	1SDA079515R1	-
				E6.2V-A/f 6000 Ekip Hi-Touch LSIG	1SDA079516R1	-

SACE Emax 2 low voltage power circuit breakers

Automatic circuit breakers
Fixed version for generators



SACE Emax E1.2B-N-S • Front terminals (F)

Size	Frame Amps	Int. Rating (kA@508V)	Withstand (kA)	Type	3 Poles		4 Poles	
					Global PN	US / CA PN	Global PN	US / CA PN
E1.2B-A	800	42	42	E1.2B-A 800 Ekip G Touch LSIG	1SDA076914R1	Z1BCUFBN200A000000XX	1SDA076994R1	ZABCUFBN200A000000XX
				E1.2B-A 800 Ekip G Hi-Touch LSIG	1SDA076917R1	Z1BCUFBQ200A000000XX	1SDA076997R1	ZABCUFBQ200A000000XX
	1200	42	42	E1.2B-A 1200 Ekip G Touch LSIG	1SDA076924R1	Z1BDUHBN200A000000XX	1SDA077004R1	ZABDUHBN200A000000XX
				E1.2B-A 1200 Ekip G Hi-Touch LSIG	1SDA076927R1	Z1BDUHBQ200A000000XX	1SDA077007R1	ZABDUHBQ200A000000XX
E1.2N-A	800	50	50	E1.2N-A 800 Ekip G Touch LSIG	1SDA076934R1	Z1NCUFBN200A000000XX	1SDA077014R1	ZANCUFBN200A000000XX
				E1.2N-A 800 Ekip G Hi-Touch LSIG	1SDA076937R1	Z1NCUFBQ200A000000XX	1SDA077017R1	ZANCUFBQ200A000000XX
	1200	50	50	E1.2N-A 1200 Ekip G Touch LSIG	1SDA076944R1	Z1NDUHBN200A000000XX	1SDA077024R1	ZANDUHBN200A000000XX
				E1.2N-A 1200 Ekip G Hi-Touch LSIG	1SDA076947R1	Z1NDUHBQ200A000000XX	1SDA077027R1	ZANDUHBQ200A000000XX
E1.2S-A	250	65	50	E1.2S-A 250 Ekip G Touch LSIG	1SDA076954R1	Z1SAUCBN200A000000XX	1SDA077034R1	ZASAUCCBN200A000000XX
				E1.2S-A 250 Ekip G Hi-Touch LSIG	1SDA076957R1	Z1SAUCBQ200A000000XX	1SDA077037R1	ZASAUCCBQ200A000000XX
	400	65	50	E1.2S-A 400 Ekip G Touch LSIG	1SDA076964R1	Z1SBUDBN200A000000XX	1SDA077044R1	ZASBUDBN200A000000XX
				E1.2S-A 400 Ekip G Hi-Touch LSIG	1SDA076967R1	Z1SBUDBQ200A000000XX	1SDA077047R1	ZASBUDBQ200A000000XX
	800	65	50	E1.2S-A 800 Ekip G Touch LSIG	1SDA076974R1	Z1SCUFBN200A000000XX	1SDA077054R1	ZASCUFBN200A000000XX
				E1.2S-A 800 Ekip G Hi-Touch LSIG	1SDA076977R1	Z1SCUFBQ200A000000XX	1SDA077057R1	ZASCUFBQ200A000000XX
	1200	65	50	E1.2S-A 1200 Ekip G Touch LSIG	1SDA076984R1	Z1SDUHBN200A000000XX	1SDA077064R1	ZASDUHBN200A000000XX
				E1.2S-A 1200 Ekip G Hi-Touch LSIG	1SDA076987R1	Z1SDUHBQ200A000000XX	1SDA077067R1	ZASDUHBQ200A000000XX

About wall mount is standard; for floor fixing must order: 1SDA076020R1 ZE1FFPF

SACE Emax 2 low voltage power circuit breakers

Automatic circuit breakers

Fixed version for generators



SACE Emax 2 E2.2 B-A, N-A, S-A, H-A, V-A • Orientable rear terminals (HR)

Size	Frame Amps	Int. Rating (kA@508V)	Withstand (kA)	Type	3 Poles		4 Poles	
					Global PN	US / CA PN	Global PN	US / CA PN
E2.2B-A	1600	42	42	E2.2B-A 1600 Ekip G Touch LSIG	1SDA077234R1	Z2BEUJBN200A000000XX	1SDA077404R1	ZBBEUJBN200A000000XX
				E2.2B-A 1600 Ekip G Hi-Touch LSIG	1SDA077237R1	Z2BEUJBQ200A000000XX	1SDA077407R1	ZBBEUJBQ200A000000XX
E2.2N-A	1600	50	50	E2.2N-A 1600 Ekip G Touch LSIG	1SDA077284R1	Z2NEUJBN200A000000XX	1SDA077454R1	ZBNEUJBN200A000000XX
				E2.2N-A 1600 Ekip G Hi-Touch LSIG	1SDA077287R1	Z2NEUJBQ200A000000XX	1SDA077457R1	ZBNEUJBQ200A000000XX
	2000	50	50	E2.2N-A 2000 Ekip G Touch LSIG	1SDA077294R1	Z2NFUKBN200A000000XX	1SDA077464R1	ZBNFUKBN200A000000XX
				E2.2N-A 2000 Ekip G Hi-Touch LSIG	1SDA077297R1	Z2NFUKBQ200A000000XX	1SDA077467R1	ZBNFUKBQ200A000000XX
E2.2S-A	800	65	65	E2.2S-A 800 Ekip G Touch LSIG	1SDA077304R1	Z2SCUFBN200A000000XX	1SDA077474R1	ZBSCUFBN200A000000XX
				E2.2S-A 800 Ekip G Hi-Touch LSIG	1SDA077307R1	Z2SCUFBQ200A000000XX	1SDA077477R1	ZBSCUFBQ200A000000XX
	1200	65	65	E2.2S-A 1200 Ekip G Touch LSIG	1SDA077314R1	Z2SDUHBN200A000000XX	1SDA077484R1	ZBSDUHBN200A000000XX
				E2.2S-A 1200 Ekip G Hi-Touch LSIG	1SDA077317R1	Z2SDUHBQ200A000000XX	1SDA077487R1	ZBSDUHBQ200A000000XX
	1600	65	65	E2.2S-A 1600 Ekip G Touch LSIG	1SDA077324R1	Z2SEUJBN200A000000XX	1SDA077494R1	ZBSEUJBN200A000000XX
				E2.2S-A 1600 Ekip G Hi-Touch LSIG	1SDA077327R1	Z2SEUJBQ200A000000XX	1SDA077497R1	ZBSEUJBQ200A000000XX
	2000	65	65	E2.2S-A 2000 Ekip G Touch LSIG	1SDA077334R1	Z2SFUKBN200A000000XX	1SDA077504R1	ZBSFUKBN200A000000XX
				E2.2S-A 2000 Ekip G Hi-Touch LSIG	1SDA077337R1	Z2SFUKBQ200A000000XX	1SDA077507R1	ZBSFUKBQ200A000000XX
E2.2H-A	800	85	85	E2.2H-A 800 Ekip G Touch LSIG	1SDA077244R1	Z2HCUFBN200A000000XX	1SDA077414R1	ZBHCUFBN200A000000XX
				E2.2H-A 800 Ekip G Hi-Touch LSIG	1SDA077247R1	Z2HCUFBQ200A000000XX	1SDA077417R1	ZBHCUFBQ200A000000XX
	1200	85	85	E2.2H-A 1200 Ekip G Touch LSIG	1SDA077254R1	Z2HDUHBN200A000000XX	1SDA077424R1	ZBHDUHBN200A000000XX
				E2.2H-A 1200 Ekip G Hi-Touch LSIG	1SDA077257R1	Z2HDUHBQ200A000000XX	1SDA077427R1	ZBHDUHBQ200A000000XX
	1600	85	85	E2.2H-A 1600 Ekip G Touch LSIG	1SDA077264R1	Z2HEUJBN200A000000XX	1SDA077434R1	ZBHEUJBN200A000000XX
				E2.2H-A 1600 Ekip G Hi-Touch LSIG	1SDA077267R1	Z2HEUJBQ200A000000XX	1SDA077437R1	ZBHEUJBQ200A000000XX
	2000	85	85	E2.2H-A 2000 Ekip G Touch LSIG	1SDA077274R1	Z2HFUKBN200A000000XX	1SDA077444R1	ZBHFUKBN200A000000XX
				E2.2H-A 2000 Ekip G Hi-Touch LSIG	1SDA077277R1	Z2HFUKBQ200A000000XX	1SDA077447R1	ZBHFUKBQ200A000000XX
E2.2V-A	250	100	85	E2.2V-A 250 Ekip G Touch LSIG	1SDA077344R1	Z2VAUCBN200A000000XX	1SDA077514R1	ZBVAUCBN200A000000XX
				E2.2V-A 250 Ekip G Hi-Touch LSIG	1SDA077347R1	Z2VAUCBQ200A000000XX	1SDA077517R1	ZBVAUCBQ200A000000XX
	400	100	85	E2.2V-A 400 Ekip G Touch LSIG	1SDA077354R1	Z2VBUDBN200A000000XX	1SDA077524R1	ZBVBUDBN200A000000XX
				E2.2V-A 400 Ekip G Hi-Touch LSIG	1SDA077357R1	Z2VBUDBQ200A000000XX	1SDA077527R1	ZBVBUDBQ200A000000XX
	800	100	85	E2.2V-A 800 Ekip G Touch LSIG	1SDA077364R1	Z2VCUFBN200A000000XX	1SDA077534R1	ZBVCUFBN200A000000XX
				E2.2V-A 800 Ekip G Hi-Touch LSIG	1SDA077367R1	Z2VCUFBQ200A000000XX	1SDA077537R1	ZBVCUFBQ200A000000XX
	1200	100	85	E2.2V-A 1200 Ekip G Touch LSIG	1SDA077374R1	Z2VDUHBN200A000000XX	1SDA077544R1	ZBVDUHBN200A000000XX
				E2.2V-A 1200 Ekip G Hi-Touch LSIG	1SDA077377R1	Z2VDUHBQ200A000000XX	1SDA077547R1	ZBVDUHBQ200A000000XX
	1600	100	85	E2.2V-A 1600 Ekip G Touch LSIG	1SDA077384R1	Z2VEUJBN200A000000XX	1SDA077554R1	ZBVEUJBN200A000000XX
				E2.2V-A 1600 Ekip G Hi-Touch LSIG	1SDA077387R1	Z2VEUJBQ200A000000XX	1SDA077557R1	ZBVEUJBQ200A000000XX
	2000	100	85	E2.2V-A 2000 Ekip G Touch LSIG	1SDA077394R1	Z2VFUKBN200A000000XX	1SDA077564R1	ZBVFUKBN200A000000XX
				E2.2V-A 2000 Ekip G Hi-Touch LSIG	1SDA077397R1	-	1SDA077567R1	-

SACE Emax 2 low voltage power circuit breakers

Automatic circuit breakers
Fixed version for generators



SACE Emax 2 E4.2 S-A, H-A, V-A • Orientable rear terminals up to 2500A (HR)

Size	Frame Amps	Int. Rating (kA@508V)	Withstand (kA)	Type	3 Poles		4 Poles	
					Global PN	US / CA PN	Global PN	US / CA PN
E4.2S-A	2500	65	65	E4.2S-A 2500 Ekip G Touch LSIG	1SDA078004R1	Z4SGULBN200A000000XX	1SDA078234R1	ZCSGULBN200A000000XX
				E4.2S-A 2500 Ekip G Hi-Touch LSIG	1SDA078007R1	Z4SGULBQ200A000000XX	1SDA078237R1	ZCSGULBQ200A000000XX
	3200	65	65	E4.2S-A 3200 Ekip G Touch LSIG	1SDA078014R1	Z4SHUNBN200A000000XX	1SDA078244R1	ZCSHUNBN200A000000XX
				E4.2S-A 3200 Ekip G Hi-Touch LSIG	1SDA078017R1	Z4SHUNBQ200A000000XX	1SDA078247R1	ZCSHUNBQ200A000000XX
	3600	65	65	E4.2S-A 3600 Ekip G Touch LSIG	1SDA078024R1	Z4SZUSBQ200A000000XX	-	-
				E4.2S-A 3600 Ekip G Hi-Touch LSIG	1SDA078027R1	Z4SZUSBQ200A000000XX	-	-
E4.2H-A	2500	85	85	E4.2H-A 2500 Ekip G Touch LSIG	1SDA077914R1	Z4HGULBN200A000000XX	1SDA078144R1	ZCHGULBN200A000000XX
				E4.2H-A 2500 Ekip G Hi-Touch LSIG	1SDA077917R1	Z4HGULBQ200A000000XX	1SDA078147R1	ZCHGULBQ200A000000XX
	3200	85	85	E4.2H-A 3200 Ekip G Touch LSIG	1SDA077924R1	Z4HHUNBN200A000000XX	1SDA078154R1	ZCHHUNBN200A000000XX
				E4.2H-A 3200 Ekip G Hi-Touch LSIG	1SDA077927R1	Z4HHUNBQ200A000000XX	1SDA078157R1	ZCHHUNBQ200A000000XX
	3600	85	85	E4.2H-A 3600 Ekip G Touch LSIG	1SDA077934R1	Z4HZUSBQ200A000000XX	-	-
				E4.2H-A 3600 Ekip G Hi-Touch LSIG	1SDA077937R1	Z4HZUSBQ200A000000XX	-	-
E4.2V-A	800	100	85	E4.2V-A 800 Ekip G Touch LSIG	1SDA078034R1	Z4VCUFBN200A000000XX	1SDA078264R1	ZCVCUFBN200A000000XX
				E4.2V-A 800 Ekip G Hi-Touch LSIG	1SDA078037R1	Z4VCUFBQ200A000000XX	1SDA078267R1	ZCVCUFBQ200A000000XX
	1600	100	85	E4.2V-A 1600 Ekip G Touch LSIG	1SDA078044R1	Z4VEUJBN200A000000XX	1SDA078274R1	ZCVEUJBN200A000000XX
				E4.2V-A 1600 Ekip G Hi-Touch LSIG	1SDA078047R1	Z4VEUJBQ200A000000XX	1SDA078277R1	ZCVEUJBQ200A000000XX
	2000	100	85	E4.2V-A 2000 Ekip G Touch LSIG	1SDA078054R1	Z4VFUKBN200A000000XX	1SDA078284R1	ZCVFUKBN200A000000XX
				E4.2V-A 2000 Ekip G Hi-Touch LSIG	1SDA078057R1	Z4VFUKBQ200A000000XX	1SDA078287R1	ZCVFUKBQ200A000000XX
	2500	100	85	E4.2V-A 2500 Ekip G Touch LSIG	1SDA078064R1	Z4VGULBN200A000000XX	1SDA078294R1	ZCVGULBN200A000000XX
				E4.2V-A 2500 Ekip G Hi-Touch LSIG	1SDA078067R1	Z4VGULBQ200A000000XX	1SDA078297R1	ZCVGULBQ200A000000XX
	3200	100	85	E4.2V-A 3200 Ekip G Touch LSIG	1SDA078074R1	Z4VHUNBN200A000000XX	1SDA078304R1	ZCVHUNBN200A000000XX
				E4.2V-A 3200 Ekip G Hi-Touch LSIG	1SDA078077R1	Z4VHUNBQ200A000000XX	1SDA078307R1	ZCVHUNBQ200A000000XX
	3600	100	85	E4.2V-A 3600 Ekip G Touch LSIG	1SDA078084R1	Z4VZUSBQ200A000000XX	-	-
				E4.2V-A 3600 Ekip G Hi-Touch LSIG	1SDA078087R1	Z4VZUSBQ200A000000XX	-	-

*6000A ratings only with rear vertical terminals.

SACE Emax 2 low voltage power circuit breakers

Automatic circuit breakers

Fixed version for generators



SACE Emax 2 E6.2 H-A, V-A • Orientable rear terminals up to 5000A (HR)

Size	Frame Amps	Int. Rating (kA@508V)	Withstand (kA)	Type	3 Poles		4 Poles	
					Global PN	US / CA PN	Global PN	US / CA PN
E6.2H-A	4000	85	85	E6.2H-A 4000 Ekip G Touch LSIG	1SDA078834R1	Z6HJURBN200A000000XX	1SDA078954R1	ZDHJURBN200A000000XX
				E6.2H-A 4000 Ekip G Hi-Touch LSIG	1SDA078837R1	Z6HJURBQ200A000000XX	1SDA078957R1	ZDHJURBQ200A000000XX
	5000	85	85	E6.2H-A 5000 Ekip G Touch LSIG	1SDA078844R1	Z6HKUSBN200A000000XX	1SDA078964R1	ZDHKUSBN200A000000XX
				E6.2H-A 5000 Ekip G Hi-Touch LSIG	1SDA078847R1	Z6HKUSBQ200A000000XX	1SDA078967R1	ZDHKUSBQ200A000000XX
	6000*	85	85	E6.2H-A 6000 Ekip G Touch LSIG	1SDA078854R1	Z6HLUTBN200A000000XX	1SDA078974R1	ZDHLUTBN200A000000XX
				E6.2H-A 6000 Ekip G Hi-Touch LSIG	1SDA078855R1	Z6HLUTBJ200A000000XX	1SDA078977R1	ZDHLUTBQ200A000000XX
E6.2V-A	4000	100	100	E6.2V-A 4000 Ekip G Touch LSIG	1SDA078894R1	Z6VJURBN200A000000XX	1SDA079014R1	ZDVJURBN200A000000XX
				E6.2V-A 4000 Ekip G Hi-Touch LSIG	1SDA078897R1	Z6VJURBQ200A000000XX	1SDA079017R1	ZDVJURBQ200A000000XX
	5000	100	100	E6.2V-A 5000 Ekip G Touch LSIG	1SDA078904R1	Z6VKUSBN200A000000XX	1SDA079024R1	ZDVKUSBN200A000000XX
				E6.2V-A 5000 Ekip G Hi-Touch LSIG	1SDA078907R1	Z6VKUSBQ200A000000XX	1SDA079027R1	ZDVKUSBQ200A000000XX
	6000*	100	100	E6.2V-A 6000 Ekip G Touch LSIG	1SDA078914R1	Z6VLUTBN200A000000XX	-	-
				E6.2V-A 6000 Ekip G Hi-Touch LSIG	1SDA078917R1	Z6VLUTBQ200A000000XX	-	-

*6000A ratings only with rear vertical terminals.

SACE Emax 2 low voltage power circuit breakers

Automatic circuit breakers
Fixed version for generators



SACE Emax 2 E6.2 H-A/f, V-A/f • Orientable rear terminals up to 5000A (HR)

Size	Frame Amps	Int. Rating (kA@508V)	Withstand (kA)	Type	4 Poles	
					Global PN	US / CA PN
E6.2H-A/f	4000	85	85	E6.2H-A/f 4000 Ekip G Touch LSIG	1SDA079314R1	ZEHJURBN200A000000XX
				E6.2H-A/f 4000 Ekip G Hi-Touch LSIG	1SDA079317R1	ZEHJURBQ200A000000XX
	5000	85	85	E6.2H-A/f 5000 Ekip G Touch LSIG	1SDA079324R1	ZEHKUSBN200A000000XX
				E6.2H-A/f 5000 Ekip G Hi-Touch LSIG	1SDA079327R1	ZEHKUSBQ200A000000XX
	6000*	85	85	E6.2H-A/f 6000 Ekip G Touch LSIG	1SDA079334R1	ZEHLUTBN200A000000XX
				E6.2H-A/f 6000 Ekip G Hi-Touch LSIG	1SDA079337R1	ZEHLUTBQ200A000000XX
E6.2V-A/f	4000	100	100	E6.2V-A/f 4000 Ekip G Touch LSIG	1SDA079374R1	ZEVJURBN200A000000XX
				E6.2V-A/f 4000 Ekip G Hi-Touch LSIG	1SDA079377R1	ZEVJURBQ200A000000XX
	5000	100	100	E6.2V-A/f 5000 Ekip G Touch LSIG	1SDA079384R1	ZEVKUSBN200A000000XX
				E6.2V-A/f 5000 Ekip G Hi-Touch LSIG	1SDA079387R1	ZEVKUSBQ200A000000XX
	6000*	100	100	E6.2V-A/f 6000 Ekip G Touch LSIG	1SDA079394R1	ZEVLUTBN200A000000XX
				E6.2V-A/f 6000 Ekip G Hi-Touch LSIG	1SDA079397R1	ZEVLUTBQ200A000000XX

*6000A ratings only with rear vertical terminals.

SACE Emax 2 low voltage power circuit breakers

Automatic circuit breakers

Drawout version for generators



SACE Emax 2 E1.2 B-A, N-A, S-A • Mobile part of drawout circuit breaker (MP)

Size	Frame Amps	Int. Rating (kA@508V)	Withstand (kA)	Type	3 Poles		4 Poles	
					Global PN	US / CA PN	Global PN	US / CA PN
E1.2B-A	800	42	42	E1.2B-A 800 Ekip G Touch L SIG	1SDA077074R1	Z1BCUFAN200A000000XX	1SDA077154R1	ZABCUFAN200A000000XX
				E1.2B-A 800 Ekip G Hi-Touch L SIG	1SDA077077R1	Z1BCUFAQ200A000000XX	1SDA077157R1	ZABCUFAQ200A000000XX
	1200	42	42	E1.2B-A 1200 Ekip G Touch L SIG	1SDA077084R1	Z1BDUHAN200A000000XX	1SDA077164R1	ZABDUHAN200A000000XX
				E1.2B-A 1200 Ekip G Hi-Touch L SIG	1SDA077087R1	Z1BDUHAQ200A000000XX	1SDA077167R1	ZABDUHAQ200A000000XX
E1.2N-A	800	50	50	E1.2N-A 800 Ekip G Touch L SIG	1SDA077094R1	Z1NCUFAN200A000000XX	1SDA077174R1	ZANCUFAN200A000000XX
				E1.2N-A 800 Ekip G Hi-Touch L SIG	1SDA077097R1	Z1NCUFAQ200A000000XX	1SDA077177R1	ZANCUFAQ200A000000XX
	1200	50	50	E1.2N-A 1200 Ekip G Touch L SIG	1SDA077104R1	Z1INDUHAN200A000000XX	1SDA077184R1	ZANDUHAN200A000000XX
				E1.2N-A 1200 Ekip G Hi-Touch L SIG	1SDA077107R1	Z1INDUHAQ200A000000XX	1SDA077187R1	ZANDUHAQ200A000000XX
E1.2S-A	250	65	50	E1.2S-A 250 Ekip G Touch L SIG	1SDA077114R1	Z1SAUCAN200A000000XX	1SDA077194R1	ZASAU CAN200A000000XX
				E1.2S-A 250 Ekip G Hi-Touch L SIG	1SDA077117R1	Z1SAUCAQ200A000000XX	1SDA077197R1	ZASAUCAQ200A000000XX
	400	65	50	E1.2S-A 400 Ekip G Touch L SIG	1SDA077124R1	Z1SBUDAN200A000000XX	1SDA077204R1	ZASBUDAN200A000000XX
				E1.2S-A 400 Ekip G Hi-Touch L SIG	1SDA077127R1	Z1SBUDAQ200A000000XX	1SDA077207R1	ZASBUDAQ200A000000XX
	800	65	50	E1.2S-A 800 Ekip G Touch L SIG	1SDA077134R1	Z1SCUFAN200A000000XX	1SDA077214R1	ZASCUFAN200A000000XX
				E1.2S-A 800 Ekip G Hi-Touch L SIG	1SDA077137R1	Z1SCUFAQ200A000000XX	1SDA077217R1	ZASCUFAQ200A000000XX
	1200	65	50	E1.2S-A 1200 Ekip G Touch L SIG	1SDA077144R1	Z1SDUHAN200A000000XX	1SDA077224R1	ZASDUHAN200A000000XX
				E1.2S-A 1200 Ekip G Hi-Touch L SIG	1SDA077147R1	Z1SDUHAQ200A000000XX	1SDA077227R1	ZASDUHAQ200A000000XX

SACE Emax 2 low voltage power circuit breakers

Automatic circuit breakers

Drawout version for generators



SACE Emax 2 E2.2 B-A, N-A, S-A, H-A, V-A • Mobile part of drawout circuit breaker (MP)

Size	Frame Amps	Int. Rating (kA@508V)	Withstand (kA)	Type	3 Poles		4 Poles	
					Global PN	US / CA PN	Global PN	US / CA PN
E2.2B-A	1600	42	42	E2.2B-A 1600 Ekip G Touch LSIG	1SDA077574R1	Z2BEUJAN200A000000XX	1SDA077744R1	ZBBEUJAN200A000000XX
				E2.2B-A 1600 Ekip G Hi-Touch LSIG	1SDA077577R1	Z2BEUJQA200A000000XX	1SDA077747R1	ZBBEUJQA200A000000XX
E2.2N-A	1600	50	50	E2.2N-A 1600 Ekip G Touch LSIG	1SDA077624R1	Z2NEUJAN200A000000XX	1SDA077794R1	ZBNEUJAN200A000000XX
				E2.2N-A 1600 Ekip G Hi-Touch LSIG	1SDA077627R1	Z2NEUJQA200A000000XX	1SDA077797R1	ZBNEUJQA200A000000XX
	2000	50	50	E2.2N-A 2000 Ekip G Touch LSIG	1SDA077634R1	Z2NFUKAN200A000000XX	1SDA077804R1	ZBNFUKAN200A000000XX
				E2.2N-A 2000 Ekip G Hi-Touch LSIG	1SDA077637R1	Z2NFUQA200A000000XX	1SDA077807R1	ZBNFUQA200A000000XX
E2.2S-A	800	65	65	E2.2S-A 800 Ekip G Touch LSIG	1SDA077644R1	Z2SCUFAN200A000000XX	1SDA077814R1	ZBSCUFAN200A000000XX
				E2.2S-A 800 Ekip G Hi-Touch LSIG	1SDA077647R1	Z2SCUFAQ200A000000XX	1SDA077817R1	ZBSCUFAQ200A000000XX
	1200	65	65	E2.2S-A 1200 Ekip G Touch LSIG	1SDA077654R1	Z2SDUHAN200A000000XX	1SDA077824R1	ZBSDUHAN200A000000XX
				E2.2S-A 1200 Ekip G Hi-Touch LSIG	1SDA077657R1	Z2SDUHAQ200A000000XX	1SDA077827R1	ZBSDUHAQ200A000000XX
	1600	65	65	E2.2S-A 1600 Ekip G Touch LSIG	1SDA077664R1	Z2SEUJAN200A000000XX	1SDA077834R1	ZBSEUJAN200A000000XX
				E2.2S-A 1600 Ekip G Hi-Touch LSIG	1SDA077667R1	Z2SEUJQA200A000000XX	1SDA077837R1	ZBSEUJQA200A000000XX
2000	65	65	E2.2S-A 2000 Ekip G Touch LSIG	1SDA077674R1	Z2SFUKAN200A000000XX	1SDA077844R1	ZBSFUKAN200A000000XX	
			E2.2S-A 2000 Ekip G Hi-Touch LSIG	1SDA077677R1	Z2SFUQA200A000000XX	1SDA077847R1	ZBSFUQA200A000000XX	
E2.2H-A	800	85	85	E2.2H-A 800 Ekip G Touch LSIG	1SDA077584R1	Z2HCUFAN200A000000XX	1SDA077754R1	ZBHCUFAN200A000000XX
				E2.2H-A 800 Ekip G Hi-Touch LSIG	1SDA077587R1	Z2HCUFAQ200A000000XX	1SDA077757R1	ZBHCUFAQ200A000000XX
	1200	85	85	E2.2H-A 1200 Ekip G Touch LSIG	1SDA077594R1	Z2HDUHAN200A000000XX	1SDA077764R1	ZBHDUHAN200A000000XX
				E2.2H-A 1200 Ekip G Hi-Touch LSIG	1SDA077597R1	Z2HDUHAQ200A000000XX	1SDA077767R1	ZBHDUHAQ200A000000XX
	1600	85	85	E2.2H-A 1600 Ekip G Touch LSIG	1SDA077604R1	Z2HEUJAN200A000000XX	1SDA077774R1	ZBHEUJAN200A000000XX
				E2.2H-A 1600 Ekip G Hi-Touch LSIG	1SDA077607R1	Z2HEUJQA200A000000XX	1SDA077777R1	ZBHEUJQA200A000000XX
2000	85	85	E2.2H-A 2000 Ekip G Touch LSIG	1SDA077614R1	Z2HFUKAN200A000000XX	1SDA077784R1	ZBHFUKAN200A000000XX	
			E2.2H-A 2000 Ekip G Hi-Touch LSIG	1SDA077617R1	Z2HFUQA200A000000XX	1SDA077787R1	ZBHFUQA200A000000XX	
E2.2V-A	250	100	85	E2.2V-A 250 Ekip G Touch LSIG	1SDA077684R1	Z2VAUCAN200A000000XX	1SDA077854R1	ZBVAUCAN200A000000XX
				E2.2V-A 250 Ekip G Hi-Touch LSIG	1SDA077687R1	Z2VAUCAQ200A000000XX	1SDA077857R1	ZBVAUCAQ200A000000XX
	400	100	85	E2.2V-A 400 Ekip G Touch LSIG	1SDA077694R1	Z2VBUDAN200A000000XX	1SDA077864R1	ZBVBUDAN200A000000XX
				E2.2V-A 400 Ekip G Hi-Touch LSIG	1SDA077697R1	Z2VBUDAQ200A000000XX	1SDA077867R1	ZBVBUDAQ200A000000XX
	800	100	85	E2.2V-A 800 Ekip G Touch LSIG	1SDA077704R1	Z2VCUFAN200A000000XX	1SDA077874R1	ZBVCUFAN200A000000XX
				E2.2V-A 800 Ekip G Hi-Touch LSIG	1SDA077707R1	Z2VCUFAQ200A000000XX	1SDA077877R1	ZBVCUFAQ200A000000XX
	1200	100	85	E2.2V-A 1200 Ekip G Touch LSIG	1SDA077714R1	Z2VDUHAN200A000000XX	1SDA077884R1	ZBVDUHAN200A000000XX
				E2.2V-A 1200 Ekip G Hi-Touch LSIG	1SDA077717R1	Z2VDUHAQ200A000000XX	1SDA077887R1	ZBVDUHAQ200A000000XX
	1600	100	85	E2.2V-A 1600 Ekip G Touch LSIG	1SDA077724R1	Z2VEUJAN200A000000XX	1SDA077894R1	ZBVEUJAN200A000000XX
				E2.2V-A 1600 Ekip G Hi-Touch LSIG	1SDA077727R1	Z2VEUJQA200A000000XX	1SDA077897R1	ZBVEUJQA200A000000XX
2000	100	85	E2.2V-A 2000 Ekip G Touch LSIG	1SDA077734R1	Z2VFUKAN200A000000XX	1SDA077904R1	ZBVFUKAN200A000000XX	
			E2.2V-A 2000 Ekip G Hi-Touch LSIG	1SDA077737R1	Z2VFUQA200A000000XX	1SDA077907R1	ZBVFUQA200A000000XX	

SACE Emax 2 low voltage power circuit breakers

Automatic circuit breakers

Drawout version for generators



SACE Emax 2 E4.2 S-A, H-A, V-A • Mobile part of drawout circuit breaker (MP)

Size	Frame Amps	Int. Rating (kA@508V)	Withstand (kA)	Type	3 Poles		4 Poles	
					Global PN	US / CA PN	Global PN	US / CA PN
E4.2S-A	2500	65	65	E4.2S-A 2500 Ekip G Touch LSIG	1SDA078464R1	Z4SGULAN200A000000XX	1SDA078694R1	ZCSGULAN200A000000XX
				E4.2S-A 2500 Ekip G Hi-Touch LSIG	1SDA078467R1	Z4SGULAQ200A000000XX	1SDA078697R1	ZCSGULAQ200A000000XX
	3200	65	65	E4.2S-A 3200 Ekip G Touch LSIG	1SDA078474R1	Z4SHUNAN200A000000XX	1SDA078704R1	ZCSHUNAN200A000000XX
				E4.2S-A 3200 Ekip G Hi-Touch LSIG	1SDA078477R1	Z4SHUNAQ200A000000XX	1SDA078707R1	ZCSHUNAQ200A000000XX
E4.2H-A	2500	85	85	E4.2H-A 2500 Ekip G Touch LSIG	1SDA078374R1	Z4HGULAN200A000000XX	1SDA078604R1	ZCHGULAN200A000000XX
				E4.2H-A 2500 Ekip G Hi-Touch LSIG	1SDA078377R1	Z4HGULAQ200A000000XX	1SDA078607R1	ZCHGULAQ200A000000XX
	3200	85	85	E4.2H-A 3200 Ekip G Touch LSIG	1SDA078384R1	Z4HHUNAN200A000000XX	1SDA078614R1	ZCHHUNAN200A000000XX
				E4.2H-A 3200 Ekip G Hi-Touch LSIG	1SDA078387R1	Z4HHUNAQ200A000000XX	1SDA078617R1	ZCHHUNAQ200A000000XX
E4.2V-A	800	100	85	E4.2V-A 800 Ekip G Touch LSIG	1SDA078494R1	Z4VCUFAN200A000000XX	1SDA078724R1	ZCVCUFAN200A000000XX
				E4.2V-A 800 Ekip G Hi-Touch LSIG	1SDA078497R1	Z4VCUFAQ200A000000XX	1SDA078727R1	ZCVCUFAQ200A000000XX
	1600	100	85	E4.2V-A 1600 Ekip G Touch LSIG	1SDA078504R1	Z4VEUJAN200A000000XX	1SDA078734R1	ZCVEUJAN200A000000XX
				E4.2V-A 1600 Ekip G Hi-Touch LSIG	1SDA078507R1	Z4VEUJAQ200A000000XX	1SDA078737R1	ZCVEUJAQ200A000000XX
	2000	100	85	E4.2V-A 2000 Ekip G Touch LSIG	1SDA078514R1	Z4VFUKAN200A000000XX	1SDA078744R1	ZCVFUKAN200A000000XX
				E4.2V-A 2000 Ekip G Hi-Touch LSIG	1SDA078517R1	Z4VFUKAQ200A000000XX	1SDA078747R1	ZCVFUKAQ200A000000XX
	2500	100	85	E4.2V-A 2500 Ekip G Touch LSIG	1SDA078524R1	Z4VGULAN200A000000XX	1SDA078754R1	ZCVGULAN200A000000XX
				E4.2V-A 2500 Ekip G Hi-Touch LSIG	1SDA078527R1	Z4VGULAQ200A000000XX	1SDA078757R1	ZCVGULAQ200A000000XX
	3200	100	85	E4.2V-A 3200 Ekip G Touch LSIG	1SDA078534R1	Z4VHUNAN200A000000XX	1SDA078764R1	ZCVHUNAN200A000000XX
				E4.2V-A 3200 Ekip G Hi-Touch LSIG	1SDA078537R1	Z4VHUNAQ200A000000XX	1SDA078767R1	ZCVHUNAQ200A000000XX

*3200A ratings only with rear vertical terminals
Contact local sales for availability for L version

SACE Emax 2 low voltage power circuit breakers

Automatic circuit breakers

Drawout version for generators



SACE Emax 2 E6.2 H-A, V-A - Mobile part of drawout circuit breaker (MP)

Size	Frame Amps	Int. Rating (kA@508V)	Withstand (kA)	Type	3 Poles		4 Poles	
					Global PN	US / CA PN	Global PN	US / CA PN
E6.2H-A	4000	85	85	E6.2H-A 4000 Ekip G Touch LSIG	1SDA079074R1	Z6HJURAN200A000000XX	1SDA079194R1	ZDHJURAN200A000000XX
				E6.2H-A 4000 Ekip G Hi-Touch LSIG	1SDA079077R1	Z6HJURAQ200A000000XX	1SDA079197R1	ZDHJURAQ200A000000XX
	5000	85	85	E6.2H-A 5000 Ekip G Touch LSIG	1SDA079084R1	Z6HKUSAN200A000000XX	1SDA079204R1	ZDHKUSAN200A000000XX
				E6.2H-A 5000 Ekip G Hi-Touch LSIG	1SDA079087R1	Z6HKUSAQ200A000000XX	1SDA079207R1	ZDHKUSAQ200A000000XX
	6000*	85	85	E6.2H-A 6000 Ekip G Touch LSIG	1SDA079094R1	Z6HLUTAN200A000000XX	1SDA079214R1	ZDHLUTAN200A000000XX
				E6.2H-A 6000 Ekip G Hi-Touch LSIG	1SDA079097R1	Z6HLUTAQ200A000000XX	1SDA079217R1	ZDHLUTAQ200A000000XX
E6.2V-A	4000	100	100	E6.2V-A 4000 Ekip G Touch LSIG	1SDA079134R1	Z6VJURAN200A000000XX	1SDA079254R1	ZDVJURAN200A000000XX
				E6.2V-A 4000 Ekip G Hi-Touch LSIG	1SDA079137R1	Z6VJURAQ200A000000XX	1SDA079257R1	ZDVJURAQ200A000000XX
	5000	100	100	E6.2V-A 5000 Ekip G Touch LSIG	1SDA079144R1	Z6VKUSAN200A000000XX	1SDA079264R1	ZDVKUSAN200A000000XX
				E6.2V-A 5000 Ekip G Hi-Touch LSIG	1SDA079147R1	Z6VKUSAQ200A000000XX	1SDA079265R1	ZDVKUSAJ200A000000XX
	6000*	100	100	E6.2V-A 6000 Ekip G Touch LSIG	1SDA079154R1	Z6VLUTAN200A000000XX	-	-
				E6.2V-A 6000 Ekip G Hi-Touch LSIG	1SDA079157R1	Z6VLUTAQ200A000000XX	-	-

*6000A ratings only with rear vertical terminals.

SACE Emax 2 low voltage power circuit breakers

Automatic circuit breakers

Drawout version for generators



SACE Emax 2 E6.2 H-A/f, V-A/f - Mobile part of drawout circuit breaker (MP)

Size	Frame Amps	Int. Rating (kA@508V)	Withstand (kA)	Type	4 Poles	
					Global PN	US / CA PN
E6.2H-A/f	4000	85	85	E6.2H-A/f 4000 Ekip G Touch LSIg	1SDA079434R1	ZEHJURAN200A000000XX
				E6.2H-A/f 4000 Ekip G Hi-Touch LSIg	1SDA079437R1	ZEHJURAQ200A000000XX
	5000	85	85	E6.2H-A/f 5000 Ekip G Touch LSIg	1SDA079444R1	ZEHKUSAN200A000000XX
				E6.2H-A/f 5000 Ekip G Hi-Touch LSIg	1SDA079447R1	ZEHKUSAQ200A000000XX
	6000*	85	85	E6.2H-A/f 6000 Ekip G Touch LSIg	1SDA079454R1	ZEHLUTAN200A000000XX
				E6.2H-A/f 6000 Ekip G Hi-Touch LSIg	1SDA079457R1	ZEHLUTAQ200A000000XX
E6.2V-A/f	4000	100	100	E6.2V-A/f 4000 Ekip G Touch LSIg	1SDA079494R1	ZEVJURAN200A000000XX
				E6.2V-A/f 4000 Ekip G Hi-Touch LSIg	1SDA079497R1	ZEVJURAQ200A000000XX
	5000	100	100	E6.2V-A/f 5000 Ekip G Touch LSIg	1SDA079504R1	ZEVKUSAN200A000000XX
				E6.2V-A/f 5000 Ekip G Hi-Touch LSIg	1SDA079507R1	ZEVKUSAQ200A000000XX
	6000*	100	100	E6.2V-A/f 6000 Ekip G Touch LSIg	1SDA079514R1	ZEVLUTAN200A000000XX
				E6.2V-A/f 6000 Ekip G Hi-Touch LSIg	1SDA079517R1	ZEVLUTAQ200A000000XX

*6000A ratings only with rear vertical terminals.

SACE Emax 2 low voltage power circuit breakers

Switch disconnectors

Fixed version



SACE Emax 2 E1.2 B-A/MS, N-A/MS • Front terminals (F)

Size	Frame Amps	Withstand (kA)	Type	3 Poles		4 Poles	
				Global PN	US / CA PN	Global PN	US / CA PN
E1.2B-A/MS	800	42	E1.2B-A/MS 800	1SDA079548R1	Z1BC00B000000000000XX	1SDA079552R1	ZABC00B000000000000XX
	1200	42	E1.2B-A/MS 1200	1SDA079549R1	Z1BD00B0000000000000XX	1SDA079553R1	ZABD00B0000000000000XX
E1.2N-A/MS	800	50	E1.2N-A/MS 800	1SDA079550R1	Z1NC00B0000000000000XX	1SDA079554R1	ZANC00B0000000000000XX
	1200	50	E1.2N-A/MS 1200	1SDA079551R1	Z1ND00B0000000000000XX	1SDA079555R1	ZAND00B0000000000000XX

About wall mount is standard; for floor fixing must order: 1SDA076020R1 ZE1FFPF



SACE Emax 2 E2.2 N-A/MS, S-A/MS, V-A/MS • Orientable rear terminals (HR)

Size	Frame Amps	Withstand (kA)	Type	3 Poles		4 Poles	
				Global PN	US / CA PN	Global PN	US / CA PN
E2.2N-A/MS	1600	50	E2.2N-A/MS 1600	1SDA079570R1	Z2NE00B0000000000000XX	1SDA079578R1	ZBNE00B0000000000000XX
	2000	50	E2.2N-A/MS 2000	1SDA079571R1	Z2NF00B0000000000000XX	1SDA079579R1	ZBNF00B0000000000000XX
E2.2S-A/MS	800	65	E2.2S-A/MS 800	1SDA079564R1	Z2SC00B0000000000000XX	1SDA079572R1	ZBSC00B0000000000000XX
	1600	65	E2.2S-A/MS 1600	1SDA079565R1	Z2SE00B0000000000000XX	1SDA079573R1	ZBSE00B0000000000000XX
	2000	65	E2.2S-A/MS 2000	1SDA079566R1	Z2SF00B0000000000000XX	1SDA079574R1	ZBSF00B0000000000000XX
E2.2V-A/MS	800	85	E2.2V-A/MS 800	1SDA079567R1	Z2VC00B0000000000000XX	1SDA079575R1	ZBVC00B0000000000000XX
	1600	85	E2.2V-A/MS 1600	1SDA079568R1	Z2VE00B0000000000000XX	1SDA079576R1	ZBVE00B0000000000000XX
	2000	85	E2.2V-A/MS 2000	1SDA079569R1	Z2VF00B0000000000000XX	1SDA079577R1	ZBVF00B0000000000000XX

SACE Emax 2 low voltage power circuit breakers

Switch disconnectors

Fixed version



SACE Emax 2 E4.2 S-A/MS, H-A/MS, V-A/MS • Orientable rear terminals up to 2500A (HR)

Size	Frame Amps	Withstand (kA)	Type	3 Poles		4 Poles	
				Global PN	US / CA PN	Global PN	US / CA PN
E4.2S-A/MS	2500	65	E4.2S-A/MS 2500	1SDA079596R1	Z4SG00B000000000000XX	1SDA079612R1	ZCSG00B000000000000XX
	3200*	65	E4.2S-A/MS 3200	1SDA079597R1	Z4SH00B000000000000XX	1SDA079613R1	ZCSH00B000000000000XX
	3600*	65	E4.2S-A/MS 3600	1SDA079598R1	Z4SZ00B000000000000XX	-	-
E4.2H-A/MS	2500	85	E4.2H-A/MS 2500	1SDA081867R1	Z4HG00B000000000000XX	1SDA081872R1	ZCHG00B000000000000XX
	3200*	85	E4.2H-A/MS 3200	1SDA081868R1	Z4HH00B000000000000XX	1SDA081873R1	ZCHH00B000000000000XX
	3600*	85	E4.2H-A/MS 3600	1SDA079611R1	Z4HZ00B000000000000XX	-	-
E4.2V-A/MS	800	100	E4.2V-A/MS 800	1SDA081864R1	Z4VC00B000000000000XX	1SDA081869R1	ZCVC00B000000000000XX
	1600	100	E4.2V-A/MS 1600	1SDA081865R1	Z4VE00B000000000000XX	1SDA081870R1	ZCVE00B000000000000XX
	2000	100	E4.2V-A/MS 2000	1SDA081866R1	Z4VF00B000000000000XX	1SDA081871R1	ZCVF00B000000000000XX
	2500	100	E4.2V-A/MS 2500	1SDA079602R1	Z4VG00B000000000000XX	1SDA079618R1	ZCVG00B000000000000XX
	3200*	100	E4.2V-A/MS 3200	1SDA079603R1	Z4VH00B000000000000XX	1SDA079619R1	ZCVH00B000000000000XX
	3600*	100	E4.2V-A/MS 3600	1SDA079604R1	Z4VZ00B000000000000XX	-	-

* 3200/3600A ratings only with rear vertical terminals



SACE Emax 2 E6.2 L-A/MS • Orientable rear terminals up to 5000A (HR)

Size	Frame Amps	Withstand (kA)	Type	3 Poles		4 Poles	
				Global PN	US / CA PN	Global PN	US / CA PN
E6.2L-A/MS	4000	100	E6.2L-A/MS 4000	1SDA079660R1	Z6LJ00B000000000000XX	1SDA079666R1	ZDLJ00B000000000000XX
	5000	100	E6.2L-A/MS 5000	1SDA079661R1	Z6LK00B000000000000XX	1SDA079667R1	ZDLK00B000000000000XX
	6000*	100	E6.2L-A/MS 6000	1SDA079662R1	Z6LL00B000000000000XX	-	-

*6000A ratings only with rear vertical terminals.

SACE Emax 2 E6.2 L-A/f/MS • Orientable rear terminals up to 5000A (HR)

Size	Frame Amps	Withstand (kA)	Type	4 Poles	
				Global PN	US / CA PN
E6.2L-A/f/MS	4000	100	E6.2L-A/f/MS 4000	1SDA079684R1	ZDLJ00B000000000000XX
	5000	100	E6.2L-A/f/MS 5000	1SDA079685R1	ZDLK00B000000000000XX
	6000*	100	E6.2L-A/f/MS 6300	-	-

*6000A ratings only with rear vertical terminals.

SACE Emax 2 low voltage power circuit breakers

Switch disconnectors

Drawout version



SACE Emax 2 E1.2 B-A/MS, N-A/MS • Mobile part of switch disconnector (MP)

Size	Frame Amps	Withstand (kA)	Type	3 Poles		4 Poles	
				Global PN	US / CA PN	Global PN	US / CA PN
E1.2B-A/MS	800	42	E1.2B-A/MS 800	1SDA079556R1	Z1BC00A0000000000000XX	1SDA079560R1	ZABC00A0000000000000XX
	1200	42	E1.2B-A/MS 1200	1SDA079557R1	Z1BD00A0000000000000XX	1SDA079561R1	ZABD00A0000000000000XX
E1.2N-A/MS	800	50	E1.2N-A/MS 800	1SDA079558R1	Z1NC00A0000000000000XX	1SDA079562R1	ZANC00A0000000000000XX
	1200	50	E1.2N-A/MS 1200	1SDA079559R1	Z1ND00A0000000000000XX	1SDA079563R1	ZAND00A0000000000000XX



SACE Emax 2 E2.2 N-A/MS, S-A/MS, V-A/MS • Mobile part of switch disconnector (MP)

Size	Frame Amps	Withstand (kA)	Type	3 Poles		4 Poles	
				Global PN	US / CA PN	Global PN	US / CA PN
E2.2N-A/MS	1600	50	E2.2N-A/MS 1600	1SDA079586R1	Z2NE00A0000000000000XX	1SDA079594R1	ZBNE00A0000000000000XX
	2000	50	E2.2N-A/MS 2000	1SDA079587R1	Z2NF00A0000000000000XX	1SDA079595R1	ZBNF00A0000000000000XX
E2.2S-A/MS	800	65	E2.2S-A/MS 800	1SDA079580R1	Z2SC00A0000000000000XX	1SDA079588R1	ZBSC00A0000000000000XX
	1600	65	E2.2S-A/MS 1600	1SDA079581R1	Z2SE00A0000000000000XX	1SDA079589R1	ZBSE00A0000000000000XX
	2000	65	E2.2S-A/MS 2000	1SDA079582R1	Z2SF00A0000000000000XX	1SDA079590R1	ZBSF00A0000000000000XX
E2.2V-A/MS	800	85	E2.2V-A/MS 800	1SDA079583R1	Z2VC00A0000000000000XX	1SDA079591R1	ZBVC00A0000000000000XX
	1600	85	E2.2V-A/MS 1600	1SDA079584R1	Z2VE00A0000000000000XX	1SDA079592R1	ZBVE00A0000000000000XX
	2000	85	E2.2V-A/MS 2000	1SDA079585R1	Z2VF00A0000000000000XX	1SDA079593R1	ZBVF00A0000000000000XX



SACE Emax 2 E4.2 S-A/MS, H-A/MS, V-A/MS • Mobile part of switch disconnector (MP)

Size	Frame Amps	Withstand (kA)	Type	3 Poles		4 Poles	
				Global PN	US / CA PN	Global PN	US / CA PN
E4.2S-A/MS	2500	65	E4.2S-A/MS 2500	1SDA079628R1	Z4SG00A0000000000000XX	1SDA079644R1	ZCSG00A0000000000000XX
	3200	65	E4.2S-A/MS 3200	1SDA079629R1	Z4SH00A0000000000000XX	1SDA079645R1	ZCSH00A0000000000000XX
E4.2H-A/MS	2500	85	E4.2H-A/MS 2500	1SDA081877R1	Z4HG00A0000000000000XX	1SDA081882R1	ZCHG00A0000000000000XX
	3200	85	E4.2H-A/MS 3200	1SDA081878R1	Z4HH00A0000000000000XX	1SDA081883R1	ZCHH00A0000000000000XX
E4.2V-A/MS	800	100	E4.2V-A/MS 800	1SDA081874R1	Z4VC00A0000000000000XX	1SDA081879R1	ZCVC00A0000000000000XX
	1600	100	E4.2V-A/MS 1600	1SDA081875R1	Z4VE00A0000000000000XX	1SDA081880R1	ZCVE00A0000000000000XX
	2000	100	E4.2V-A/MS 2000	1SDA081876R1	Z4VF00A0000000000000XX	1SDA081881R1	ZCVF00A0000000000000XX
	2500	100	E4.2V-A/MS 2500	1SDA079634R1	Z4VG00A0000000000000XX	1SDA079650R1	ZCVG00A0000000000000XX
	3200	100	E4.2V-A/MS 3200	1SDA079635R1	Z4VH00A0000000000000XX	1SDA079651R1	ZCVH00A0000000000000XX

SACE Emax 2 low voltage power circuit breakers

Switch disconnectors

Drawout version



SACE Emax 2 E6.2 L-A/MS • Mobile part of switch disconnector (MP)

Size	Frame Amps	Withstand (kA)	Type	3 Poles		4 Poles	
				Global PN	US / CA PN	Global PN	US / CA PN
E6.2L-A/MS	4000	100	E6.2L-A/MS 4000	1SDA079672R1	Z6LJ00A000000000000XX	1SDA079678R1	ZDLJ00A000000000000XX
	5000	100	E6.2L-A/MS 5000	1SDA079673R1	Z6LK00A000000000000XX	1SDA079679R1	ZDLK00A000000000000XX
	6000*	100	E6.2L-A/MS 6000	1SDA079674R1	Z6LL00A000000000000XX	-	-

*6000A ratings only with rear vertical terminals.

SACE Emax 2 E6.2 L-A/f/MS • Mobile part of switch disconnector (MP)

Size	Frame Amps	Withstand (kA)	Type	4 Poles	
				Global PN	US / CA PN
E6.2L-A/f/MS	4000	100	E6.2L-A/f/MS 4000	1SDA079690R1	ZELJ00A000000000000XX
	5000	100	E6.2L-A/f/MS 5000	1SDA079691R1	ZELK00A000000000000XX
	6000*	100	E6.2L-A/f/MS 6000	-	-

*6000A ratings only with rear vertical terminals.

SACE Emax 2 low voltage power circuit breakers
Circuit breakers

Multi-Standard: IEC 60947 / UL1066 / CSA / CCC

Size	Performance	Description	3 Poles		4 Poles	
			Global PN	US / CA PN	Global PN	US / CA PN
E2.2	B	Triple certific: UL/IEC/CCC E2.2B-A EXT	1SDA083020R1	Factory installed only	1SDA083020R1	Factory installed only
E2.2	N	Triple certific: UL/IEC/CCC E2.2N-A EXT	1SDA083021R1	Factory installed only	1SDA083021R1	Factory installed only
E2.2	S	Triple certific: UL/IEC/CCC E2.2S-A EXT	1SDA083022R1	Factory installed only	1SDA083022R1	Factory installed only
E2.2	H	Triple certific: UL/IEC/CCC E2.2H-A EXT	1SDA083023R1	Factory installed only	1SDA083023R1	Factory installed only
E2.2	V	Triple certific: UL/IEC/CCC E2.2V-A EXT	1SDA083024R1	Factory installed only	1SDA083024R1	Factory installed only
E4.2	S	Triple certific: UL/IEC/CCC E4.2S-A EXT	1SDA083025R1	Factory installed only	1SDA083025R1	Factory installed only
E4.2	H	Triple certific: UL/IEC/CCC E4.2H-A EXT	1SDA083026R1	Factory installed only	1SDA083026R1	Factory installed only
E4.2	V	Triple certific: UL/IEC/CCC E4.2V-A EXT	1SDA083027R1	Factory installed only	1SDA083027R1	Factory installed only
E6.2	V	Triple certific: UL/IEC/CCC E6.2V-A EXT	1SDA083028R1	Factory installed only	1SDA083028R1	Factory installed only

The multiple-standard Emax2 can be ordered in the same way you accessories are ordered:

1. Select the right UL circuit breaker you need;
2. Like an accessory configuration, upgrade the circuit breaker with multi-standard performance by adding the code shown above.

SACE Emax 2 low voltage power circuit breakers Cradles



Size	Performance	Amperage range	Terminal type	Type	3 Poles		4 Poles	
					Global PN	US / CA PN	Global PN	US / CA PN
E1.2	B-A, N-A, S-A	250 - 1200	HR - HR	E1.2-A W FP Iu=1200 HR HR UL	1SDA079696R1	Z1A12A0XX	1SDA079697R1	ZAA12A0XX
E2.2	B-A, N-A, S-A, H-A, V-A	250 - 2000	HR - HR	E2.2-A W FP Iu=2000 HR HR UL	1SDA079698R1	Z2A20A0XX	1SDA079699R1	ZBA20A0XX
E4.2	S-A, H-A, V-A, L-A	800 - 2500	HR - HR	E4.2-A W FP Iu=2500 HR HR UL	1SDA079700R1	Z4A25A0XX	1SDA079701R1	ZCA25A0XX
	S-A, H-A, V-A, L-A	3200	VR-VR	E4.2-A W FP Iu=3200 VR VR UL	1SDA079702R1	Z4A32A0XX	1SDA079703R1	ZCA32A0XX
E6.2	H-A, V-A, L-A	4000 - 5000	HR - HR	E6.2-A W FP Iu=5000 HR HR UL	1SDA079706R1	Z6A50A0XX	1SDA079707R1	ZDA50A0XX
				E6.2-A/f W FP Iu=5000 HR HR UL	-	-	1SDA079708R1	ZEA50A0XX
	H-A, V-A, L-A	6000	VR - VR	E6.2-A W FP Iu=6000 VR VR UL	1SDA079709R1	Z6A60A0XX	-	-

SACE Emax 2 low voltage power circuit breakers

Accessories

Electrical accessories



First and second shunt coil - YO

Size	Type	Global PN	US / CA PN
E1.2..E6.2	YO E1.2..E6.2 24 Vac/dc	1SDA073668R1	ZEASA
E1.2..E6.2	YO E1.2..E6.2 30 Vac/dc	1SDA073669R1	ZEASB
E1.2..E6.2	YO E1.2..E6.2 48 Vac/dc	1SDA073670R1	ZEASC
E1.2..E6.2	YO E1.2..E6.2 60 Vac/dc	1SDA073671R1	ZEASD
E1.2..E6.2	YO E1.2..E6.2 110-120 Vac/dc	1SDA073672R1	ZEASE
E1.2..E6.2	YO E1.2..E6.2 120-127 Vac/dc	1SDA073673R1	ZEASF
E1.2..E6.2	YO E1.2..E6.2 220-240 Vac/dc	1SDA073674R1	ZEASG
E1.2..E6.2	YO E1.2..E6.2 240-250 Vac/dc	1SDA073675R1	ZEASH
E1.2..E6.2	YO E1.2..E6.2 380-400 Vac	1SDA073677R1	ZEASK
E1.2..E6.2	YO E1.2..E6.2 415-440 Vac	1SDA073678R1	ZEASL
E1.2..E6.2	YO E1.2..E6.2 480-500 Vac	1SDA073679R1	ZEASM

Second shunt coils are an alternative to a UVR or anti-racking out device (fail safe)

First and second closing coil - YC

Size	Type	Global PN	US / CA PN
E1.2..E6.2	YC E1.2..E6.2 24 Vac/dc	1SDA073681R1	ZEACA
E1.2..E6.2	YC E1.2..E6.2 30 Vac/dc	1SDA073682R1	ZEACB
E1.2..E6.2	YC E1.2..E6.2 48 Vac/dc	1SDA073683R1	ZEACC
E1.2..E6.2	YC E1.2..E6.2 60 Vac/dc	1SDA073684R1	ZEACD
E1.2..E6.2	YC E1.2..E6.2 110-120 Vac/dc	1SDA073685R1	ZEACE
E1.2..E6.2	YC E1.2..E6.2 120-127 Vac/dc	1SDA073686R1	ZEACF
E1.2..E6.2	YC E1.2..E6.2 220-240 Vac/dc	1SDA073687R1	ZEACG
E1.2..E6.2	YC E1.2..E6.2 240-250 Vac/dc	1SDA073688R1	ZEACH
E1.2..E6.2	YC E1.2..E6.2 380-400 Vac	1SDA073690R1	ZEACK
E1.2..E6.2	YC E1.2..E6.2 415-440 Vac	1SDA073691R1	ZEACL
E1.2..E6.2	YC E1.2..E6.2 480-500 Vac	1SDA073692R1	ZEACM

Shunt coil and closing coil test unit - YO/YC Test Unit (IEC only)

Size	Type	Global PN	US / CA PN
E1.2..E6.2	YO/YC test unit E1.2...E6.2	1SDA082751R1	ZEAYOYCT

SACE Emax 2 low voltage power circuit breakers

Accessories

Electrical accessories

Undervoltage coil - YU

Size	Type	Global PN	US / CA PN
E1.2..E6.2	YU E1.2..E6.2 24 Vac/dc	1SDA073694R1	ZEAUA
E1.2..E6.2	YU E1.2..E6.2 30 Vac/dc	1SDA073695R1	ZEAUB
E1.2..E6.2	YU E1.2..E6.2 48 Vac/dc	1SDA073696R1	ZEAUC
E1.2..E6.2	YU E1.2..E6.2 60 Vac/dc	1SDA073697R1	ZEAUD
E1.2..E6.2	YU E1.2..E6.2 110-120 Vac/dc	1SDA073698R1	ZEAUE
E1.2..E6.2	YU E1.2..E6.2 120-127 Vac/dc	1SDA073699R1	ZEAUF
E1.2..E6.2	YU E1.2..E6.2 220-240 Vac/dc	1SDA073700R1	ZEAUG
E1.2..E6.2	YU E1.2..E6.2 240-250 Vac/dc	1SDA073701R1	ZEAUH
E1.2..E6.2	YU E1.2..E6.2 380-400 Vac	1SDA073703R1	ZEAUK
E1.2..E6.2	YU E1.2..E6.2 415-440 Vac	1SDA073704R1	ZEAUL
E1.2..E6.2	YU E1.2..E6.2 440-500 Vac	1SDA073705R1	ZEAUM

The undervoltage coil is an alternative to a second shunt coil or anti-racking out device (fail safe)

Electronic time-delay device for undervoltage coil - UVD

Size	Type	Global PN	US / CA PN
E1.2..E6.2	24-30 Vdc	1SDA038316R1	ZEATL9
E1.2..E6.2	48 Vac/dc	1SDA038317R1	ZEATL8
E1.2..E6.2	60 Vac/dc	1SDA038318R1	ZEATL7
E1.2..E6.2	110...127 Vac/dc	1SDA038319R1	ZEATL5
E1.2..E6.2	220...250 Vac/dc	1SDA038320R1	ZEATL3

The electronic time-delay device must be used with an undervoltage coil with the same voltage

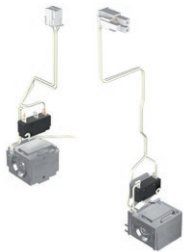

Remote reset - YR

Size	Type	Global PN	US / CA PN
E1.2	YR 24 Vdc E1.2	1SDA073744R1	ZE1YRA
E1.2	YR 110 Vac/dc E1.2	1SDA073745R1	ZE1YRB
E1.2	YR 220 Vac/dc E1.2	1SDA073746R1	ZE1YRC
E2.2..E6.2	YR 24 Vdc E2.2...E6.2	1SDA073747R1	ZEBYRA
E2.2..E6.2	YR 110 Vac/dc E2.2...E6.2	1SDA073748R1	ZEBYRB
E2.2..E6.2	YR 220 Vac/Dc E2.2...E6.2	1SDA073749R1	ZEBYRC

When the remote reset is used in DC, its activation must be done with a maximum impulse time of 50ms. It can not be powered permanently.

SACE Emax 2 low voltage power circuit breakers

Accessories

Electrical accessories



Motor - M

Size	Type	Global PN	US / CA PN
E1.2	M E1.2 24-30 Vac/dc + MC 250V	1SDA073708R1	ZE1M2
E1.2	M E1.2 48-60 Vac/dc + MC 250V	1SDA073709R1	ZE1M3
E1.2	M E1.2 100-130 Vac/dc + MC 250V	1SDA073710R1	ZE1M4
E1.2	M E1.2 220-250 Vac/dc + MC 250V	1SDA073711R1	ZE1M5
E1.2	M E1.2 380-415 Vac + MC 250V	1SDA073713R1	ZE1M7
E2.2..E6.2	M E2.2...E6.2 24-30 Vac/dc + MC 400V	1SDA073722R1	ZEBM2
E2.2..E6.2	M E2.2...E6.2 48-60 Vac/dc + MC 400V	1SDA073723R1	ZEBM3
E2.2..E6.2	M E2.2...E6.2 100-130 Vac/dc + MC 400V	1SDA073724R1	ZEBM4
E2.2..E6.2	M E2.2...E6.2 220-250 Vac/dc + MC 400V	1SDA073725R1	ZEBM5
E2.2..E6.2	M E2.2...E6.2 380-415 Vac + MC 400V	1SDA073727R1	ZEBM7
E1.2	M E1.2 24-30 Vac/dc + MC 24V	1SDA073715R1	ZE1MA
E1.2	M E1.2 48-60 Vac/dc + MC 24V	1SDA073716R1	ZE1MB
E1.2	M E1.2 100-130 Vac/dc + MC 24V	1SDA073717R1	ZE1MC
E1.2	M E1.2 220-250 Vac/dc + MC 24V	1SDA073718R1	ZE1MD
E1.2	M E1.2 380-415 Vac + MC 24V	1SDA073720R1	ZE1MF
E2.2..E6.2	M E2.2...E6.2 24-30 Vac/dc + MC 24V	1SDA073729R1	ZEBMA
E2.2..E6.2	M E2.2...E6.2 48-60 Vac/dc + MC 24V	1SDA073730R1	ZEBMB
E2.2..E6.2	M E2.2...E6.2 100-130 Vac/dc + MC 24V	1SDA073731R1	ZEBMC
E2.2..E6.2	M E2.2...E6.2 220-250 Vac/dc + MC 24V	1SDA073732R1	ZEBMD



Current sensor for external neutral

Size	Type	Global PN	US / CA PN
E1.2-E2.2	Ext CS N E1.2 - E2.2	1SDA082134R1	ZE1NCT
E4.2-E6.2	Ext CS N E4.2-E6.2 50%	1SDA082135R1	ZE6NCT
E6.2 FS	Ext CS N E6.2 100%	1SDA082136R1	ZE6NCTF
E1.2-E2.2	Ext CS N E1.2 - E2.2 2000A for 1% CB * **	1SDA107553R1	ZE1NCTE1PCT
E2.2	Ext CS N E2.2 2500A for 1% CB * **	1SDA107554R1	ZE2NCT1PCT
E4.2	Ext CS N E4.2 3200A for 1% CB * **	1SDA107555R1	ZE4NCT1PCT
E4.2-E6.2	Ext CS N E4.2 4000A - E6.2 N 50% for 1% CB * **	1SDA107556R1	ZE6NCTE1PCT
E6.2	Ext CS N E6.2 for 1% CB * **	1SDA107557R1	ZE6NCTFE1PCT
E1.2-E2.2	Ext CS N E1.2 - E2.2 UL for 1% CB**	1SDA107558R1	ZE1NCT1PCT
E4.2-E6.2	Ext CS N E4.2 - E6.2 50% UL for 1% CB**	1SDA107559R1	ZE6NCT1PCT
E6.2 FS	Ext CS N E6.2 100% UL for 1% CB**	1SDA107560R1	ZE6NCTF1PCT

* IEC only

** To be used with circuit-breakers equipped with 1% accuracy feature. The external neutral is not certified for 1% accuracy.



Homopolar toroid for the earthing conductor of the main power supply (Transformer star center sensor input) (IEC only)

Size	Type	Global PN	US / CA PN
E1.2..E6.2	Homopolar toroid E1.2...E6.2 100A*	1SDA073743R1	ZEAHT100
E1.2..E6.2	Homopolar toroid E1.2...E6.2 250A*	1SDA076248R1	ZEAHT250
E1.2..E6.2	Homopolar toroid E1.2...E6.2 400A*	1SDA076249R1	ZEAHT400
E1.2..E6.2	Homopolar toroid E1.2...E6.2 800A*	1SDA076250R1	ZEAHT800

The homopolar toroid is an alternative to the toroid for differential protection; (*) Only as loose part

SACE Emax 2 low voltage power circuit breakers

Accessories

Electrical accessories



Toroid for differential protection (Rc residual current protection sensor input) (IEC only)

Size	Type	Global PN	US / CA PN
E1.2 & E2.2 3p	Toroid RC E1.2, E2.2 3p [*]	1SDA073741R1	ZE12RCT1
E2.2 4p & E4.2	Toroide RC E2 4p, E4.2 [*]	1SDA073742R1	ZE24RCT2

The toroid for differential protection is an alternative to the homopolar toroid for the earthing conductor of the main power supply;

*Only as loose part



Dedicated terminal for Modified Differential Ground Fault (MDGF) protection

Size	Type	Global PN	US / CA PN
E1.2..E6.2	MDGF Terminal for fixed circuit breaker [*]	1SDA114800R1	ZEAMDGFF
E1.2..E6.2	MDGF Terminal for withdrawable circuit breaker [*]	1SDA114798R1	ZEAMDGFW

*The commercial code includes one piece.

External phase current transformers and summing current transformers must be purchased separately.



Open closed auxiliary contacts - AUX

Size	Type	Global PN	US / CA PN
E1.2**	AUX 4Q (4 Form C) 400V E1.2	1SDA073750R1	ZE1AUX4
E1.2	AUX 4Q (4 Form C) 24V E1.2	1SDA073751R1	ZE1AUX4D
E1.2	AUX 2Q (2 Form C) 400V + 2Q (2 Form C) 24V E1.2	1SDA073752R1	ZE1AUX2-2D
E2.2..E6.2**	AUX 4Q (4 Form C) 400V E2.2...E6.2	1SDA073753R1	ZEB AUX4
E2.2..E6.2	AUX 4Q (4 Form C) 24V E2.2...E6.2	1SDA073754R1	ZEB AUX4D
E2.2..E6.2	AUX 2Q (2 Form C) 400V + 2Q (2 Form C) 24V E2.2...E6.2	1SDA073755R1	ZEB AUX2-2D
E2.2..E6.2	AUX 6Q 400V E2.2...E6.2 ¹	1SDA073756R1	ZEB AUX6
E2.2..E6.2	AUX 6Q 24V E2.2...E6.2 ¹	1SDA073757R1	ZEB AUX6D
E2.2..E6.2	AUX 3Q (3 Form C) 400V + 3Q (3 Form C) 24V E2.2...E6.2 ¹	1SDA075973R1	ZEB AUX3-3D
E1.2	AUX 15Q (15 Form C) 400V E1.2 ² *	1SDA073758R1	ZE1AUX15
E1.2	AUX 15Q (15 Form C) 24V E1.2 ² *	1SDA073759R1	ZE1AUX15D
E2.2..E6.2	AUX 15Q (15 Form C) 400V (for fixed/drawout with signalling in racked in) E2.2...E6.2 ^{2*}	1SDA073760R1	ZEB AUX15
E2.2..E6.2	AUX 15Q (15 Form C) 24V (for fixed/drawout with signalling in racked in) E2.2...E6.2 ^{2*}	1SDA073761R1	ZEB AUX15D
E2.2..E6.2	AUX 15Q (15 Form C) 400V (for fixed/drawout with signalling in racked in/test isolated) E2.2...E6.2 ^{2*}	1SDA073846R1	ZEB AUX15RT
E2.2..E6.2	AUX 15Q (15 Form C) 24V (for fixed/drawout with signalling in racked in/test isolated) E2.2...E6.2 ^{2*}	1SDA073847R1	ZEB AUX15DRT

¹AUX 6Q (6 Form C) is an alternative to the Ekip Signalling 4k module

²Aux 15 Q (15 Form C) is an alternative to the Mechanical interlock (MI), the lock to prevent door opening when the circuit breaker is in the closed position (DLC) or the lock to prevent door opening when the circuit breaker is in the racked in or test position (DCP) when mounted on the right side. For E1.2 one of the mounting plates is also needed.

For E1.2 you need to order also one of the following items:

Plate for fixed - floor mounted 1SDA079783R1 ZE1AUX15PLF
 Plate for fixed - wall mounted 1SDA079782R1 ZE1AUX15PLW

Plate for withdrawable 1SDA079784R1 ZE1AUX15PLMP

* Not compatible with mechanical locks on compartment doors or mechanical interlocks

** Standard supply with automatic circuit-breakers



SACE Emax 2 low voltage power circuit breakers

Accessories

Electrical accessories



Auxiliary position contacts - AUP

Size	Type	Global PN	US / CA PN
E1.2	AUP 6 contacts 400V E1.2	1SDA073762R1	ZE1AUP
E1.2	AUP 6 contacts 24V E1.2	1SDA073763R1	ZE1AUPD
E2.2...E6.2	AUP 5 contacts 400V E2.2...E6.2 - left set	1SDA080373R1	ZEBAUP-L
E2.2...E6.2	AUP 5 contacts 24V E2.2...E6.2 - left set	1SDA080374R1	ZEBAUPD-L
E2.2...E6.2	AUP 5 suppl. contacts 400V E2.2...E6.2 - right set	1SDA080375R1	ZEBAUP-R
E2.2...E6.2	AUP 5 suppl. contacts 24V E2.2...E6.2 - right set	1SDA080376R1	ZEBAUPD-R
E1.2...E6.2	AUP Ekip auxiliary position contact E1.2...E6.2	1SDA073768R1	ZEAAUPE



Ready to close signalling contact - RTC

Size	Type	Global PN	US / CA PN
E1.2	RTC 250V E1.2	1SDA073770R1	ZE1RTC
E1.2	RTC 24V E1.2	1SDA073771R1	ZE1RTCD
E1.2	RTC Ekip 24V E1.2	1SDA073772R1	ZE1RTCDE
E2.2...E6.2	RTC 250V E2.2...E6.2	1SDA073773R1	ZEBRTC
E2.2...E6.2	RTC 24V E2.2...E6.2	1SDA073774R1	ZEBRTCD
E2.2...E6.2	RTC Ekip 24V E2.2...E6.2	1SDA073775R1	ZEBRTCDE



Trip signalling contact - S51 / bell alarm

Size	Type	Global PN	US / CA PN
E1.2	S51 / bell alarm 250V E1.2*	1SDA073776R1	ZE1BA
E1.2	S51 / bell alarm 24V E1.2	1SDA073777R1	ZE1BAD
E2.2...E6.2	S51 / bell alarm 250V E2.2...E6.2*	1SDA073778R1	ZEBBA
E2.2...E6.2	S51 / bell alarm 24V E2.2...E6.2	1SDA073779R1	ZEBBAD
E2.2...E6.2	250V E2.2...E6.2	1SDA085699R1	ZEBBA2
E2.2...E6.2	24V E2.2...E6.2	1SDA085700R1	ZEBBAD2

*Standard supply with automatic circuit-breakers

Terminal blocks for auxiliary connection

Size	Type	Global PN	US / CA PN
E1.2..E6.2	Terminal blocks 10 pcs	1SDA073906R1	ZEATB10
E1.2..E6.2	Terminal blocks 8 pcs INST	1SDA114779R1	-
E1.2..E6.2	Terminal blocks 18 pcs INST	1SDA114780R1	-

SACE Emax 2 low voltage power circuit breakers

Accessories

Mechanical accessories



Mechanical operation counter - MOC

Size	Type	Global PN	US / CA PN
E1.2	MOC mechanical operation counter*	1SDA073780R1	ZE1MOC
E2.2...E6.2	MOC mechanical operation counter	1SDA073781R1	ZEBMOC

*Only available with motor



Key lock in open position - KLC

Size	Type	Global PN	US / CA PN
E1.2	KLC-D Key lock open E1.2	1SDA073782R1	ZE1KLCD
E1.2	KLC-S Key lock open N.20005 E1.2	1SDA073783R1	ZE1KLCS5
E1.2	KLC-S Key lock open N.20006 E1.2	1SDA073784R1	ZE1KLCS6
E1.2	KLC-S Key lock open N.20007 E1.2	1SDA073785R1	ZE1KLCS7
E1.2	KLC-S Key lock open N.20008 E1.2	1SDA073786R1	ZE1KLCS8
E1.2	KLC-S Key lock open N.20009 E1.2	1SDA073787R1	ZE1KLCS9
E1.2	KLC-A Key lock open Castell E1.2 ^{1,2}	1SDA073788R1	ZE1KLAC
E1.2	KLC-A Key lock open Kirk E1.2 ¹	1SDA073789R1	ZE1KLAK
E1.2	KLC-A Key lock open Ronis Profalux E1.2 ¹	1SDA073790R1	ZE1KLAR
E2.2...E6.2	KLC-D Key lock open E2.2...E6.2	1SDA073791R1	ZEBKLCD
E2.2...E6.2	KLC-S Key lock open N.20005 E2.2...E6.2	1SDA073792R1	ZEBKLCS5
E2.2...E6.2	KLC-S Key lock open N.20006 E2.2...E6.2	1SDA073793R1	ZEBKLCS6
E2.2...E6.2	KLC-S Key lock open N.20007 E2.2...E6.2	1SDA073794R1	ZEBKLCS7
E2.2...E6.2	KLC-S Key lock open N.20008 E2.2...E6.2	1SDA073795R1	ZEBKLCS8
E2.2...E6.2	KLC-S Key lock open N.20009 E2.2...E6.2	1SDA073796R1	ZEBKLCS9
E2.2...E6.2	KLC-A Key lock open Castell E2.2...E6.2 ^{1,2}	1SDA073797R1	ZEBKLAC
E2.2...E6.2	KLC-A Key lock open Kirk E2.2...E6.2 ¹	1SDA073798R1	ZEBKLAK
E2.2...E6.2	KLC-A Key lock open Ronis Profalux E2.2...E6.2 ¹	1SDA073799R1	ZEBKLAR

¹Arrangement only; ² Only mounted. For loose supply contact ABB SACE.



Padlocks in open position - PLC

Size	Type	Global PN	US / CA PN
E1.2	PLC E1.2 Padlock open D=4mm/0.15"	1SDA073800R1	ZE1PLC4
E1.2	PLC E1.2 Padlock open D=7mm/0.27"	1SDA073801R1	ZE1PLC7
E1.2	PLC E1.2 Padlock open D=8mm/0.31"	1SDA073802R1	ZE1PLC8
E2.2...E6.2	PLC E2.2...E6.2 Padlock open D=4mm/0.15"	1SDA073803R1	ZEBPLC4
E2.2...E6.2	PLC E2.2...E6.2 Padlock open D=7mm/0.27"	1SDA073804R1	ZEBPLC7
E2.2...E6.2	PLC E2.2...E6.2 Padlock open D=8mm/0.31"	1SDA073805R1	ZEBPLC8

The PLC is an alternative to the protection device for opening and closing pushbuttons (PBC)

Fixed or Mobile Part with neutral on right side

Size	Type	Global PN	US / CA PN
E1.2...E6.2	Installation with neutral on right side sequence L1, L2, L3, N ³	1SDA076153R1	Factory installed only

³When this configuration is selected, the circuit-breaker is certified for IEC61557-12 (Class 1 accuracy)

Floor fixing plate - F

Size	Type	Global PN	US / CA PN
E1.2	Floor fixing plate for fixed unit	1SDA076020R1	ZE1FFPF

SACE Emax 2 low voltage power circuit breakers

Accessories

Mechanical accessories



Key lock in racked in / test / racked out position - KLP

Size	Type	Global PN	US / CA PN
E1.2	KLP-D Key lock racked in/out E1.2 1st key	1SDA073822R1	ZE1KLPD
E1.2	KLP-S Key lock racked in/out N.20005 E1.2 1st key	1SDA073823R1	ZE1KLPS5
E1.2	KLP-S Key lock racked in/out N.20006 E1.2 1st key	1SDA073824R1	ZE1KLPS6
E1.2	KLP-S Key lock racked in/out N.20007 E1.2 1st key	1SDA073825R1	ZE1KLPS7
E1.2	KLP-S Key lock racked in/out N.20008 E1.2 1st key	1SDA073826R1	ZE1KLPS8
E1.2	KLP-S Key lock racked in/out N.20009 E1.2 1st key	1SDA073827R1	ZE1KLPS9
E1.2	KLP-D Key lock racked in/out E1.2 2nd key	1SDA073828R1	ZE1KLPD-2
E1.2	KLP-S Key lock racked in/out N.20005 E1.2 2nd key	1SDA073829R1	ZE1KLPS5-2
E1.2	KLP-S Key lock racked in/out N.20006 E1.2 2nd key	1SDA073830R1	ZE1KLPS6-2
E1.2	KLP-S Key lock racked in/out N.20007 E1.2 2nd key	1SDA073831R1	ZE1KLPS7-2
E1.2	KLP-S Key lock racked in/out N.20008 E1.2 2nd key	1SDA073832R1	ZE1KLPS8-2
E1.2	KLP-S Key lock racked in/out N.20009 E1.2 2nd key	1SDA073833R1	ZE1KLPS9-2
E1.2	KLP-A Key lock racked in/out RonProfKirk E1.2 1st key ²	1SDA073834R1	ZE1KLPR
E1.2	KLP-A Key lock racked in/out RonProfKirk E1.2 2nd key ²	1SDA073835R1	ZE1KLPR-2
E1.2	KLP-A Key lock racked in/out Castell E1.2 1st key ^{1,2}	1SDA073836R1	ZE1KLPC
E1.2	KLP-A Key lock racked in/out Castell E1.2 2nd key ^{1,2}	1SDA073837R1	ZE1KLPC-2
E2.2...E6.2	KLP-D Key lock racked in/out E2.2...E6.2 1st key	1SDA073806R1	ZEBKLPD
E2.2...E6.2	KLP-S Key lock racked in/out N.20005 E2.2...E6.2 1st key	1SDA073807R1	ZEBKLPS5
E2.2...E6.2	KLP-S Key lock racked in/out N.20006 E2.2...E6.2 1st key	1SDA073808R1	ZEBKLPS6
E2.2...E6.2	KLP-S Key lock racked in/out N.20007 E2.2...E6.2 1st key	1SDA073809R1	ZEBKLPS7
E2.2...E6.2	KLP-S Key lock racked in/out N.20008 E2.2...E6.2 1st key	1SDA073810R1	ZEBKLPS8
E2.2...E6.2	KLP-S Key lock racked in/out N.20009 E2.2...E6.2 1st key	1SDA073811R1	ZEBKLPS9
E2.2...E6.2	KLP-D Key lock racked in/out E2.2...E6.2 2nd key	1SDA073812R1	ZEBKLPD-2
E2.2...E6.2	KLP-S Key lock racked in/out N.20005 E2.2...E6.2 2nd key	1SDA073813R1	ZEBKLPS5-2
E2.2...E6.2	KLP-S Key lock racked in/out N.20006 E2.2...E6.2 2nd key	1SDA073814R1	ZEBKLPS6-2
E2.2...E6.2	KLP-S Key lock racked in/out N.20007 E2.2...E6.2 2nd key	1SDA073815R1	ZEBKLPS7-2
E2.2...E6.2	KLP-S Key lock racked in/out N.20008 E2.2...E6.2 2nd key	1SDA073816R1	ZEBKLPS8-2
E2.2...E6.2	KLP-S Key lock racked in/out N.20009 E2.2...E6.2 2nd key	1SDA073817R1	ZEBKLPS9-2
E2.2...E6.2	KLP-A Key lock racked in/out RonProfKirk E2.2...E6.2 1st key ²	1SDA073818R1	ZEBKLPR
E2.2...E6.2	KLP-A Key lock racked in/out RonProfKirk E2.2...E6.2 2nd key ²	1SDA073819R1	ZEBKLPR-2
E2.2...E6.2	KLP-A Key lock racked in/out Castell E2.2...E6.2 1st key ^{1,2}	1SDA073820R1	ZEBKLPC
E2.2...E6.2	KLP-A Key lock racked in/out Castell E2.2...E6.2 2nd key ^{1,2}	1SDA073821R1	ZEBKLPC-2

To have 2 keys, one each of a 1st key and 2nd key option must be ordered. When the Padlock in racked in/test/racked out (PLP) is also present, the 2nd key option must be ordered.

¹Two Castell key options can not be used together;

²Arrangement only



Supplementary lock in racked out position accessory

Size	Type	Global PN	US / CA PN
E1.2	Suppl. lock in racked out E1.2	1SDA073838R1	ZE1SUP
E2.2...E6.2	Suppl. lock in racked out E2.2...E6.2	1SDA073839R1	ZEBSUP



Padlock in racked in / test / racked out position - PLP

Size	Type	Global PN	US / CA PN
E1.2	PLP Padlock racked in/out E1.2	1SDA073840R1	ZE1PLP
E2.2...E6.2	PLP Padlock racked in/out E2.2...E6.2	1SDA073841R1	ZEBPLP

Can also be used with the key lock in racked in/test/racked out device when the 2nd key option is ordered.

SACE Emax 2 low voltage power circuit breakers

Accessories

Mechanical accessories

Anti-racking out device (fail safe) - FS

Size	Type	Global PN	US / CA PN
E1.2	Fail Safe E1.2	1SDA079898R1	ZE1FS
E2.2...E6.2	Fail Safe E2.2...E6.2	1SDA079899R1	ZEBFS

Standard for CBs UL, not compatible with YU



Lock for racking in / racking out the mobile part when the door is open - DLR

Size	Type	Global PN	US / CA PN
E1.2...E6.2	DLR E2.2...E6.2*	1SDA073845R1	ZEBDLR

*Only as loose part



Lock to prevent door opening when the circuit breaker is in racked in / test position - DLP

Size	Type	Global PN	US / CA PN
E2.2...E6.2	DLP E2.2...E6.2*	1SDA073849R1	ZEBDLP

If mounted on the right side, the DLP is an alternative to the mechanical interlock, AUX 15Q (15 Form C) or Lock to prevent door opening when the circuit breaker is in a closed position (DLC);

*Only as loose part

Lock to prevent door opening when the circuit breaker is in a closed position - DLC

Size	Type	Global PN	US / CA PN
E1.2	DLC Interlock cable door for fixed to wall E1.2	1SDA081032R1	ZE1DLCCDFW
E1.2	DLC Interlock cable door for fixed to floor E1.2	1SDA081033R1	ZE1DLCCDFF
E1.2	DLC Interlock cable door for fixed part withdrawable E1.2	1SDA081034R1	ZE1DLCCDFP
E1.2	DLC Interlock direct door for fixed to wall E1.2	1SDA079779R1	ZE1DLCDDFW
E1.2	DLC Interlock direct door for fixed to floor E1.2	1SDA079780R1	ZE1DLCDDFP
E1.2	DLC Interlock direct door for fixed part withdrawable E1.2	1SDA079781R1	ZE1DLCDDFP
E2.2...E6.2	DLC Interlock cable door E2.2...E6.2*	1SDA073852R1	ZEBDLCCD
E2.2...E6.2	DLC Interlock direct door E2.2...E6.2*	1SDA073853R1	ZEBDLCCD

If mounted on the right side, the DLP is an alternative to the mechanical interlock, AUX 15Q (15 Form C) or Lock to prevent door opening when the circuit breaker is in a closed position (DLC);

*To be ordered with lever for interlock [group 2] and support for interlock [1SDA073895R1]



Protection device for opening and closing pushbuttons - PBC

Size	Type	Global PN	US / CA PN
E1.2	PBC Op/Cl BP protection sp. key E1.2	1SDA073854R1	ZE1PBC
E1.2	PBC Op/Cl BP protection PL D=4mm/0.15" E1.2	1SDA073855R1	ZE1PBC4
E1.2	PBC Op/Cl BP protection PL D=7mm/0.27" E1.2	1SDA073856R1	ZE1PBC7
E1.2	PBC Op/Cl BP protection PL D=8mm/0.31" E1.2	1SDA073857R1	ZE1PBC8
E2.2...E6.2	PBC Op/Cl BP protection sp. key E2.2...E6.2	1SDA073858R1	ZEBPBC
E2.2...E6.2	PBC Op/Cl BP protection PL D=4mm/0.15" E2.2...E6.2	1SDA073859R1	ZEBPBC4
E2.2...E6.2	PBC Op/Cl BP protection PL D=7mm/0.27" E2.2...E6.2	1SDA073860R1	ZEBPBC7
E2.2...E6.2	PBC Op/Cl BP protection PL D=8mm/0.31" E2.2...E6.2	1SDA073861R1	ZEBPBC8

*The PBC is an alternative to the Padlock in open position (PLC)

SACE Emax 2 low voltage power circuit breakers

Accessories

Mechanical accessories



Circuit breaker flange / door escutcheon

Size	Type	Global PN	US / CA PN
E1.2	IP30 flange E1.2 Fixed	1SDA073862R1	ZE1FLG30F
E1.2	IP30 flange E1.2 Drawout	1SDA073863R1	ZE1FLG30D
E2.2...E6.2	IP30 flange E2.2...E6.2 Fixed	1SDA073864R1	ZEBFLG30F
E2.2...E6.2	IP30 flange E2.2...E6.2 Drawout	1SDA073865R1	ZEBFLG30D
E1.2	IP54 flange, different keys E1.2*	1SDA073866R1	ZE1FLG54DK
E2.2...E6.2	IP54 flange, different keys E2.2...E6.2*	1SDA073867R1	ZEBFLG54DK
E1.2	IP54 flange, key N.20005 E1.2*	1SDA073868R1	ZE1FLG54SK
E2.2...E6.2	IP54 flange, key N.20005 E2.2...E6.2*	1SDA073869R1	ZEBFLG54SK
E2.2...E6.2	Sealable trip unit cover E2.2...E6.2	1SDA073870R1	ZEBSTUC

*Only as loose part



High or low terminal covers - HTC/LTC

Size	Type	3 poles		4 poles	
		Global PN	US / CA PN	Global PN	US / CA PN
E1.2	HTC high terminal covers E1.2 2pcs	1SDA073871R1	ZE1HTC	1SDA073872R1	ZE1HTC-4
E1.2	LTC low terminal covers E1.2 2pcs	1SDA073873R1	ZE1LTC	1SDA073874R1	ZE1LTC-4



Separators - PB

Size	Type	Global PN	US / CA PN
E1.2	PB H=100mm/3.94" 4pcs E1.2 Fixed 3P	1SDA073877R1	ZE1PBF100
E1.2	PB H=100mm/3.94" 6pcs E1.2 Fixed 4P	1SDA073878R1	ZE1PBF100-4
E1.2	PB H=200mm/7.87" 4pcs E1.2 Fixed 3P	1SDA073879R1	ZE1PBF200
E1.2	PB H=200mm/7.87" 6pcs E1.2 Fixed 4P	1SDA073880R1	ZE1PBF200-4
E1.2	PB 2pcs E1.2 Drawout 3P	1SDA076164R1	ZE1PBW
E1.2	PB 3pcs E1.2 Drawout 4P	1SDA076165R1	ZE1PBW-4
E2.2...E6.2	PB 2pcs E2.2...E6.2 Fixed 3P	1SDA076166R1	ZEBPBF
E2.2...E6.2	PB 3pcs E2.2...E6.2 Fixed 4P	1SDA076167R1	ZEBPBF-4
E2.2...E6.2	PB 2pcs E2.2...E6.2 Drawout 3P	1SDA076168R1	ZEBPBW
E2.2...E6.2	PB 3pcs E2.2...E6.2 Drawout 4P	1SDA076169R1	ZEBPBW-4
E4.2	PB Separators E4.2 3200A/3600A UL Fixed 3P	1SDA107410R1	ZEBPBF36
E4.2	PB Separators E4.2 3200A UL Fixed 4P	1SDA107411R1	ZEBPBF32-4
E4.2	PB Separators E4.2 3200A UL Drawout 3P	1SDA107412R1	ZEBPBW32
E4.2	PB Separators E4.2 3200A UL Drawout 4P	1SDA107413R1	ZEBPBW32-4

Remote Racking Device - RRD

Size	Type	Global PN	US / CA PN
E2.2...E6.2	RRD Emax 2 E2.2...E6.2 110Vac/dc	1SDA085528R1	ZEBRRD
E2.2...E6.2	RRD Emax 2 E2.2...E6.2 220Vac/dc	1SDA085529R1	ZEBRRD2
E2.2...E6.2	Kit for fixing RRD on E2.2...E6.2**	1SDA085530R1	ZEARRDCB

**One kit per breaker needed

SACE Emax 2 low voltage power circuit breakers

Accessories

Mechanical interlock

Cables for mechanical interlock [Group 1]

Size	Type	Global PN	US / CA PN
E1.2..E6.2	Type A horizontal	1SDA073881R1	ZEACBLAHR
E2.2..E6.2	Type B,C,D horizontal	1SDA073882R1	ZEACBLBHR
E1.2..E6.2	Type A vertical	1SDA073885R1	ZEACBLAVR
E2.2..E6.2	Type B,C,D vertical	1SDA073886R1	ZEACBLBVR

On type of cable must be ordered for each interlock. The cable must be ordered with the fixed circuit breaker or the cradle of a drawout circuit breaker.

Lever for mechanical interlock of fixed circuit breaker or cradle [Group 2]

Size	Type	3 Poles		4 Poles	
		Global PN	US / CA PN	Global PN	US / CA PN
E2.2	Lever for mechanical interlock	1SDA073889R1	ZE2LEV	1SDA073889R1	ZE2LEV
E4.2	Lever for mechanical interlock	1SDA073890R1	ZE4LEV	1SDA073890R1	ZE4LEV
E6.2	Lever for mechanical interlock	1SDA073891R1	ZE6LEV	1SDA073892R1	ZE6LEV-4

The lever for the mechanical interlock is not required for E1.2

Support for mechanical interlock of fixed circuit breaker [Group 3]

Size	Type	Global PN	US / CA PN
E1.2	Type A - floor mounted	1SDA073893R1	ZE1SPA
E1.2	Type A - wall mounted	1SDA073894R1	ZE1SPAFM
E2.2...E6.2	Type A / B / D	1SDA073895R1	ZEBSPB
E2.2...E6.2	Type C	1SDA073897R1	ZEBSPC

Support for mechanical interlock of fixed part [Group 4]

Size	Type	Global PN	US / CA PN
E1.2	Type A	1SDA073896R1	ZE1SPCRDA
E2.2...E6.2	Type A / B / D	1SDA073895R1	ZEBSPB
E2.2...E6.2	Type C	1SDA073897R1	ZEBSPC

Automatic transfer switch

Size	Type	Global PN	US / CA PN
E1.2..E6.2	ATS021	1SDA065523R1	ATS021
E1.2..E6.2	ATS022	1SDA065524R1	ATS022



SACE Emax 2 low voltage power circuit breakers

Accessories
Ekip modules



Ekip trip units, Black Platform - loose supply

Size	Type	Global PN	US / CA PN
E1.2..E6.2	Ekip Dip LI (Black)	1SDA107526R1	ZEDEDLI
E1.2..E6.2	Ekip Dip LSI (Black)	1SDA107527R1	ZEDEDLSI
E1.2..E6.2	Ekip Dip LSI (Black)	1SDA107528R1	ZEDEDLSIG
E1.2..E6.2	Ekip Touch LI (Black)	1SDA107529R1	ZEDETLI
E1.2..E6.2	Ekip Touch LSI (Black)	1SDA107530R1	ZEDETLI
E1.2..E6.2	Ekip Touch LSI (Black)	1SDA107531R1	ZEDETLI
E1.2..E6.2 ¹	Ekip Hi-Touch LSI (Black)	1SDA107532R1	ZEDEHTLSI
E1.2..E6.2 ¹	Ekip Hi-Touch LSI (Black)	1SDA107533R1	ZEDEHTLSIG
E1.2..E6.2 ¹	Ekip G Touch LSI (Black)	1SDA107534R1	ZEDEGTLI
E1.2..E6.2 ¹	Ekip G Touch LSI (Black)	1SDA107535R1	ZEDEGTLI
E1.2..E6.2 ¹	Ekip LCD LI (Black)	1SDA107536R1	ZEDELCDLI
E1.2..E6.2 ¹	Ekip LCD LSI (Black)	1SDA107537R1	ZEDELCDLI
E1.2..E6.2 ¹	Ekip LCD LSI (Black)	1SDA107538R1	ZEDELCDLSIG
E1.2..E6.2 ¹	Ekip Hi-LCD LSI (Black)	1SDA107539R1	ZEDEHLCDLI
E1.2..E6.2 ¹	Ekip Hi-LCD LSI (Black)	1SDA107540R1	ZEDEHLCDLSIG
E1.2..E6.2 ¹	Ekip G LCD LSI (Black)	1SDA107541R1	ZEDEGLCDLSIG
E1.2..E6.2 ¹	Ekip G Hi-LCD LSI (Black)	1SDA107542R1	ZEDEHLCDLSIG

¹provided without Measurement Enabler/Measurement Enabler with voltage sockets
Note: In case of Ekip Touch trip unit or higher, only SW packages provided by default will be present

Options for Ekip trip units

Size	Type	Global PN	US / CA PN
E1.2..E6.2	Ekip LCD installed	1SDA074211R1	Factory installed code only
E1.2..E6.2 ³	No Bluetooth connectivity	1SDA114808R1	Factory installed code only
E1.2..E6.2	Non defeatable I protection	1SDA114799R1	Factory installed code only
E1.2..E6.2	Upper internal installed voltage outlets	1SDA074216R1	Factory installed code only
E1.2..E6.2	External installed voltage outlets	1SDA074217R1	Factory installed code only
E1.2..E6.2 ²	Arrangement for cables with lower internal voltage outlets	1SDA074213R1	Factory installed code only
E1.2..E6.2 ²	Arrangement for cables with upper internal voltage outlets	1SDA074214R1	Factory installed code only
E1.2..E6.2 ²	Arrangement for cables with external voltage outlets	1SDA074215R1	Factory installed code only

²For Ekip trip units, Grey Platform only
³Extracode suitable for Ekip Touch and Hi-Touch trip units



Power Supply modules

Size	Type	Global PN	US / CA PN
E1.2..E6.2	Ekip Supply 110-240VAC/DC	1SDA074172R1	ZEAPWRS
E1.2..E6.2	Ekip Supply 24-48VDC	1SDA074173R1	ZEAPWRS

SACE Emax 2 low voltage power circuit breakers

Accessories

Ekip modules



Connectivity modules

Size	Type	Global PN	US / CA PN
E1.2..E6.2	Ekip Com Hub	1SDA082894R1	ZEAEKIPHUB
E1.2..E6.2	Ekip Com Modbus RS-485	1SDA074150R1	ZEAMOD485
E1.2..E6.2	Ekip Com Modbus TCP	1SDA074151R1	ZEAMODTCP
E1.2..E6.2	Ekip Com Profibus	1SDA074152R1	ZEAPRFIBUS
E1.2..E6.2	Ekip Com Profinet	1SDA074153R1	ZEAPRFINET
E1.2..E6.2	Ekip Com DeviceNet	1SDA074154R1	ZEADEVICNET
E1.2..E6.2	Ekip Com EtherNet/IP	1SDA074155R1	ZEATHRNT
E1.2..E6.2	Ekip Com IEC61850	1SDA074156R1	ZEAIIEC61850
E1.2..E6.2	Ekip Com R Modbus RS-485	1SDA074157R1	ZEAMOD485R
E1.2..E6.2	Ekip Com R Modbus TCP	1SDA074158R1	ZEAMODTCP
E1.2..E6.2	Ekip Com R Profibus	1SDA074159R1	ZEAPROFIBUSR
E1.2..E6.2	Ekip Com R Profinet	1SDA074160R1	ZEAPROFINETR
E1.2..E6.2	Ekip Com R DeviceNet	1SDA074161R1	ZEADEVICENETR
E1.2..E6.2	Ekip Com R EtherNet/IP	1SDA074162R1	ZEAIIPR
E1.2..E6.2	Ekip Com R IEC61850	1SDA076170R1	-
E1.2..E6.2	Ekip Link	1SDA074163R1	ZEALINK
E1.2..E6.2	Ekip Com GPRS-M	1SDA074165R1	ZEAGPRSM
E1.2..E6.2	Ekip Com Actuator	1SDA074166R1	ZEACACT

Signalling modules

Size	Type	Global PN	US / CA PN
E1.2..E6.2	Ekip 2K-1	1SDA074167R1	ZE2K1
E1.2..E6.2	Ekip 2K-2	1SDA074168R1	ZE2K2
E1.2..E6.2	RELT Ekip 2K-3	1SDA074169R1	ZEB2K3
E2.2..E6.2 ¹	Ekip 4K (Black)	1SDA074170R1	ZED4K
E1.2..E6.2 ²	Ekip 10K	1SDA074171R1	ZE10K
E1.2..E6.2 ³	Ekip Signalling 3T-1	1SDA085693R1	ZE3T1
E1.2..E6.2 ³	Ekip Signalling 3T-2	1SDA085694R1	ZE3T2
E1.2..E6.2	Ekip Signalling Modbus TCP	1SDA082485R1	ZEASIGMBTCP

¹Ekip 4k is not available for the E1.2. It is an alternative to the AUX 6Q (6 Form C) auxiliary contacts unit on other frames; ² only as loose part;

³External probe PT100/PT1000 not supplied

External Probe for Ekip 3T Signalling modules

Size	Type	Global PN	US / CA PN
E1.2..E6.2 ⁴	External Probe PT1000 3mt	1SDA085695R1	ZE3TPR

⁴For busbar applications only. The code includes one single probe.

Measurement Enabler and Measurement Enabler with voltage sockets⁶

Size	Type	Global PN	US / CA PN
E1.2	Measurement Enabler E1.2	1SDA107543R1	ZE1MEAMOD
E1.2	Measurement Enabler with voltage sockets E1.2	1SDA107544R1	ZE1MEASOC
E2.2	Measurement Enabler E2.2	1SDA107545R1	ZE2MEAMOD
E2.2	Measurement Enabler with voltage sockets E2.2	1SDA107546R1	ZE2MEASOC
E4.2	Measurement Enabler E4.2	1SDA107547R1	ZE4MEAMOD
E4.2	Measurement Enabler with voltage sockets E4.2	1SDA107548R1	ZE4MEASOC
E6.2	Measurement Enabler E6.2	1SDA107549R1	ZE6MEAMOD
E6.2	Measurement Enabler with voltage sockets E6.2	1SDA107550R1	ZE6MEASOC
E1.2 ⁵	Voltage socket for neutral on right side L1 L2 L3 N - E1.2	1SDA076244R1	ZE1MEASOCNRT
E2.2 ⁵	Voltage socket for neutral on right side L1 L2 L3 N - E2.2	1SDA076245R1	ZE2MEASOCNRT
E4.2 ⁵	Voltage socket for neutral on right side L1 L2 L3 N - E4.2	1SDA076246R1	ZE4MEASOCNRT
E6.2 ⁵	Voltage socket for neutral on right side L1 L2 L3 N - E6.2	1SDA076247R1	ZE6MEASOCNRT

⁵Suitable for circuit-breakers with neutral on the right side (L1 L2 L3 N)

⁶The Measurement Enabler module is provided as standard with Ekip Touch trip units. Select the Measuring Package to activate measurements (V, f, P, E, ..). The Measurement Enabler with voltage sockets module is provided as standard with Ekip Hi-Touch, G Touch and G Hi-Touch trip units. Measurements are also provided as standard, with no need to activate the dedicated software package. Both these modules are available as spare parts.

SACE Emax 2 low voltage power circuit breakers

Accessories
Ekip modules



Synchrocheck module

Size	Type	Global PN	US / CA PN
E1.2..E6.2	Ekip Synchrocheck	1SDA074183R1	ZEASYNCHK

Displaying and supervision systems

Size	Type	Global PN	US / CA PN
E1.2..E6.2	Ekip T&P - Programming and Test unit	1SDA066989R1	ZEAEKPTP
E1.2..E6.2	Ekip TT - Trip Test	1SDA066988R1	ZEAEKPTT
E1.2..E6.2	Ekip Programming	1SDA076154R1	ZEAEKPPGM
E1.2..E6.2 ¹	Ekip Multimeter	1SDA074192R1	ZEAMM
E1.2..E6.2 ²	Ekip Control Panel for 10 circuit breakers	1SDA074311R1	ZEAEKPCP10
E1.2..E6.2 ²	Ekip Control Panel for 30 circuit breakers	1SDA074312R1	ZEAEKPCP30
E1.2..E6.2 ²	Ekip View Software for 30 circuit breakers	1SDA074298R1	ZEAEKPS30
E1.2..E6.2 ²	Ekip View Software for 60 circuit breakers	1SDA074299R1	ZEAEKPS60
E1.2..E6.2 ²	Ekip View Software for unlimited circuit breakers	1SDA074300R1	ZEAEKPSU

¹only as loose part

²suitable for Ekip trip units, Grey Platform only

Rating plugs for Ekip trip units

Size	Type	Global PN (loose supply)	US / CA PN (loose supply)	Global PN (installed)	US / CA PN (installed)
E1.2...E2.2	Rating Plug 100A (Black)	1SDA112840R1	ZED0100RP	1SDA074258R1	Factory installed only
E1.2...E2.2	Rating Plug 200A (Black)	1SDA112841R1	ZED0200RP	1SDA074259R1	Factory installed only
E1.2...E2.2	Rating Plug 250A (Black)	1SDA112842R1	ZED0250RP	1SDA074260R1	Factory installed only
E1.2..E6.2	Rating Plug 400A (Black)	1SDA112843R1	ZED0400RP	1SDA074261R1	Factory installed only
E1.2..E6.2 ¹	Rating Plug 600A (Black)	1SDA112844R1	ZED0600RP	1SDA079826R1	Factory installed only
E1.2..E6.2	Rating Plug 800A (Black)	1SDA112846R1	ZED0800RP	1SDA074263R1	Factory installed only
E1.2..E6.2	Rating Plug 1000A (Black)	1SDA112847R1	ZED1000RP	1SDA074264R1	Factory installed only
E1.2..E6.2 ³	Rating Plug 1200A (Black)	1SDA112848R1	ZED1200RP	1SDA079828R1	Factory installed only
E2.2..E6.2 ²	Rating Plug 1600A (Black)	1SDA112850R1	ZED1600RP	1SDA074266R1	Factory installed only
E2.2..E6.2	Rating Plug 2000A (Black)	1SDA112851R1	ZED2000RP	1SDA074267R1	Factory installed only
E2.2..E6.2 ³	Rating Plug 2500A (Black)	1SDA112852R1	ZED2500RP	1SDA074268R1	Factory installed only
E4.2..E6.2	Rating Plug 3200A (Black)	1SDA112854R1	ZED3200RP	1SDA074269R1	Factory installed only
E4.2..E6.2 ¹	Rating Plug 3600A (Black)	1SDA112855R1	ZED3600RP	1SDA112855R1	Factory installed only
E4.2..E6.2 ⁴	Rating Plug 4000A (Black)	1SDA112856R1	ZED4000RP	1SDA074270R1	Factory installed only
E6.2	Rating Plug 5000A (Black)	1SDA112857R1	ZED5000RP	1SDA074271R1	Factory installed only
E6.2 ¹	Rating Plug 6000A (Black)	1SDA112858R1	ZED6000RP	-	-

¹UL only

²IEC only for E1.2, both UL and IEC for all other frames

³IEC only for E2.2, both UL and IEC for E4.2 and E6.2

⁴IEC only for E4.2, both UL and IEC for E6.2

SACE Emax 2 low voltage power circuit breakers

Accessories

Ekip modules



Advanced functionalities

Software functions

Size	Type	Global PN	US / CA PN
E1.2..E6.2 ^a	Adaptive Load Shedding	1SDA082921R1	Factory installed/ ABB Ability Marketplace™
E1.2..E6.2 ^b	ATS Main-Tie-Main Closed Transition	1SDA082886R1	ABB Ability Marketplace™
E1.2..E6.2 ^b	ATS Main-Gen Open Transition	1SDA082889R1	ABB Ability Marketplace™
E1.2..E6.2	Power Controller	1SDA074212R1	Factory installed only

^aAvailable both factory fitted and via ABB Ability Marketplace™.

^bAvailable via ABB Ability Marketplace™ only.

Software packages

Size	Type	Global PN	US / CA PN
E1.2..E6.2	Measuring Package	1SDA107525R1	Factory installed / ABB Ability Marketplace™
E1.2..E6.2	Voltage Protection	1SDA105227R1	ABB Ability Marketplace™
E1.2..E6.2	Advanced Voltage Protection	1SDA105228R1	ABB Ability Marketplace™
E1.2..E6.2	Frequency Protection	1SDA105229R1	ABB Ability Marketplace™
E1.2..E6.2	Power Protection	1SDA105230R1	ABB Ability Marketplace™
E1.2..E6.2	ROCOF Protection	1SDA105231R1	ABB Ability Marketplace™
E1.2..E6.2	Adaptive Protection	1SDA105232R1	ABB Ability Marketplace™
E1.2..E6.2	Data Logger	1SDA105233R1	ABB Ability Marketplace™
E1.2..E6.2	Network Analyzer	1SDA105234R1	ABB Ability Marketplace™

Metering functions - Class 1 accuracy^a

Size	Type	Global PN	US / CA PN
E1.2	Class 1 Power&Energy Metering E1.2	1SDA107551R1	Factory installed only
E2.2	Class 1 Power&Energy Metering E2.2	1SDA107675R1	Factory installed only
E4.2	Class 1 Power&Energy Metering E4.2	1SDA107676R1	Factory installed only
E6.2	Class 1 Power&Energy Metering E6.2	1SDA107677R1	Factory installed only

^aExtracodes available for Ekip Touch and Ekip G Touch trip units.

SACE Emax 2 low voltage power circuit breakers

Accessories Terminals

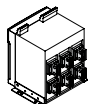

Rear orientable terminal - HR VR

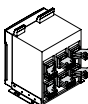

Horizontal rear spread terminal - SHR

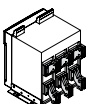

Vertical rear spread terminal - SVR

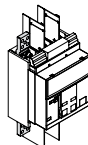

Extended front terminal - EF

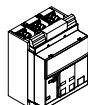

Front terminal - F

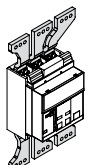

Front spread terminal - ES

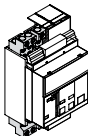

Terminal for cable FcCuAl 4x240mm² - Fc CuAl

Kit for terminals - installed on fixed circuit breaker

Size	Version	Max amperage	Type	3 Poles		4 Poles	
				Global PN	US / CA PN	Global PN	US / CA PN
E1.2	F	1200	Kit EF Upper ¹	1SDA073963R1	Factory installed only	1SDA073964R1	Factory installed only
E1.2	F	1200	Kit EF Lower ¹	1SDA073965R1	Factory installed only	1SDA073966R1	Factory installed only
E1.2	F	1200	Kit ES Upper ¹	1SDA073975R1	Factory installed only	1SDA073976R1	Factory installed only
E1.2	F	1200	Kit ES Lower ¹	1SDA073977R1	Factory installed only	1SDA073978R1	Factory installed only
E1.2	F	1200	Kit HR Upper	1SDA079840R1	Factory installed only	1SDA079841R1	Factory installed only
E1.2	F	1200	Kit HR Lower	1SDA079842R1	Factory installed only	1SDA079843R1	Factory installed only
E1.2	F	1200	Kit VR Upper	1SDA079836R1	Factory installed only	1SDA079837R1	Factory installed only
E1.2	F	1200	Kit VR Lower	1SDA079838R1	Factory installed only	1SDA079839R1	Factory installed only
E1.2	F	1200	Kit FcCuAl 4x500kcmil/240mm ² Upper ¹	1SDA073997R1	Factory installed only	1SDA073998R1	Factory installed only
E1.2	F	1200	Kit FcCuAl 4x500kcmil/240mm ² Lower ¹	1SDA073999R1	Factory installed only	1SDA074000R1	Factory installed only
E2.2	F	2000	Kit F Upper ¹	1SDA074118R1	Factory installed only	1SDA074119R1	Factory installed only
E2.2	F	2000	Kit F Lower ¹	1SDA074120R1	Factory installed only	1SDA074121R1	Factory installed only
E2.2	F	2000	Kit VR Upper	1SDA079852R1	Factory installed only	1SDA079853R1	Factory installed only
E2.2	F	2000	Kit VR Lower	1SDA079854R1	Factory installed only	1SDA079855R1	Factory installed only
E4.2	F	3200	Kit F Upper ¹	1SDA074126R1	Factory installed only	1SDA074127R1	Factory installed only
E4.2	F	3200	Kit F Lower ¹	1SDA074128R1	Factory installed only	1SDA074129R1	Factory installed only
E4.2	F	2500	Kit VR Upper	1SDA079862R1	Factory installed only	1SDA079863R1	Factory installed only
E4.2	F	2500	Kit VR Lower	1SDA079864R1	Factory installed only	1SDA079865R1	Factory installed only
E6.2	F	6000	Kit F Upper ¹	1SDA074134R1	Factory installed only	1SDA074135R1	Factory installed only
E6.2	F	6000	Kit F Lower ¹	1SDA074137R1	Factory installed only	1SDA074138R1	Factory installed only
E6.2	F	5000	Kit VR Upper	1SDA079891R1	Factory installed only	1SDA079892R1	Factory installed only
E6.2	F	5000	Kit VR Lower	1SDA079893R1	Factory installed only	1SDA079894R1	Factory installed only
E6.2/f	F	6000	Kit F Upper ¹	-	-	1SDA074136R1	Factory installed only
E6.2/f	F	6000	Kit F Lower ¹	-	-	1SDA074138R1	Factory installed only

¹Not UL listed

SACE Emax 2 low voltage power circuit breakers

Accessories Terminals

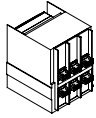

Rear orientable terminal - HR VR

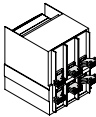

Horizontal rear terminal - SHR

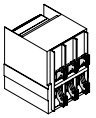

Vertical rear spread terminal - SVR

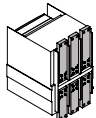

Front terminal - F

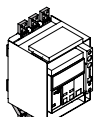

Extended front terminal - EF

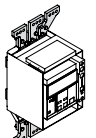

Front spread terminal - ES

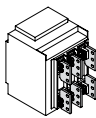

Terminal for cable FcCuAl
4x240mm² - Fc CuAl

Kit for terminals - installed on cradle

Size	Version	Max amperage	Type	3 Poles		4 Poles	
				Global PN	US / CA PN	Global PN	US / CA PN
E1.2	W	1200	Kit EF Upper ³	1SDA073939R1	Factory installed only	1SDA073940R1	Factory installed only
E1.2	W	1200	Kit EF Lower ³	1SDA073941R1	Factory installed only	1SDA073942R1	Factory installed only
E1.2	W	1200	Kit ES Upper ^{1,3)}	1SDA073951R1	Factory installed only	1SDA073952R1	Factory installed only
E1.2	W	1200	Kit ES Lower ^{1,3)}	1SDA073953R1	Factory installed only	1SDA073954R1	Factory installed only
E1.2	W	1200	Kit VR Upper	1SDA079830R1	Factory installed only	1SDA079831R1	Factory installed only
E1.2	W	1200	Kit VR Lower	1SDA079832R1	Factory installed only	1SDA079833R1	Factory installed only
E1.2	W	1200	Kit FcCuAl 4x 500kcmil/240mm ² Upper ³	1SDA073991R1	Factory installed only	1SDA073993R1	Factory installed only
E1.2	W	1200	Kit FcCuAl 4x 500kcmil/240mm ² Lower ³	1SDA073992R1	Factory installed only	1SDA073994R1	Factory installed only
E2.2	W	2000	Kit F Upper ³	1SDA074090R1	Factory installed only	1SDA074091R1	Factory installed only
E2.2	W	2000	Kit F Lower ³	1SDA074092R1	Factory installed only	1SDA074093R1	Factory installed only
E2.2	W	2000	Kit VR Upper	1SDA079846R1	Factory installed only	1SDA079847R1	Factory installed only
E2.2	W	2000	Kit VR Lower	1SDA079848R1	Factory installed only	1SDA079849R1	Factory installed only
E4.2	W	3200	Kit F Upper ³	1SDA074098R1	Factory installed only	1SDA074099R1	Factory installed only
E4.2	W	3200	Kit F Lower ³	1SDA074100R1	Factory installed only	1SDA074101R1	Factory installed only
E4.2	W	2500	Kit VR Upper	1SDA079856R1	Factory installed only	1SDA079857R1	Factory installed only
E4.2	W	2500	Kit VR Lower	1SDA079858R1	Factory installed only	1SDA079859R1	Factory installed only
E6.2	W	6000	Kit F Upper ³	1SDA074106R1	Factory installed only	1SDA074107R1	Factory installed only
E6.2	W	6000	Kit F Lower ³	1SDA074109R1	Factory installed only	1SDA074110R1	Factory installed only
E6.2	W	5000	Kit VR Upper	1SDA079882R1	Factory installed only	1SDA079883R1	Factory installed only
E6.2	W	5000	Kit VR Lower	1SDA079885R1	Factory installed only	1SDA079886R1	Factory installed only
E6.2/f	W	6000	Kit F Upper ³	-	-	1SDA074108R1	-
E6.2/f	W	6000	Kit F Lower ³	-	-	1SDA074111R1	-
E6.2/f	W	5000	Kit VR Upper	-	Factory installed only	1SDA079884R1	Factory installed only
E6.2/f	W	5000	Kit VR Lower	-	Factory installed only	1SDA079887R1	Factory installed only

¹ES terminals can be ordered only if the cradle also has EF terminals.

²Vertical terminals are supplied as standard for E4.2, 3200A. For this size and amperage, HR is not possible.

³Not UL listed

SACE Emax 2 low voltage power circuit breakers

Accessories Terminals

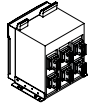

Rear orientable terminal - HR VR

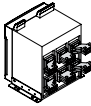

Horizontal rear spread terminal - SHR

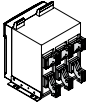

Vertical rear spread terminal - SVR

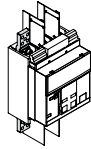

Extended front terminal - EF

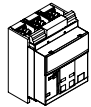

Front terminal - F

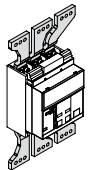

Front spread terminal - ES

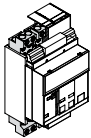

Terminal for cable FcCuAl 4x240mm² - Fc CuAl

Kit for terminals - loose supply for one side of fixed circuit breaker

Size	Version	Max amperage	Type	3 pieces		4 pieces	
				Global PN	US / CA PN	Global PN	US / CA PN
E1.2	F	1200	Kit EF ¹	1SDA073967R1	ZE1EFF	1SDA073968R1	ZE1EFF-4
E1.2	F	1200	Kit F	1SDA073973R1	ZE1FF	1SDA073973R1	ZE1FF
E1.2	F	1200	Kit ES ¹	1SDA073979R1	ZE1ESF	1SDA073980R1	ZE1ESF-4
E1.2	F	1200	Kit Adjustable HR/VR	1SDA079844R1	ZE1HRVRF	1SDA079845R1	ZE2HRVRF-4
E1.2	F	1200	Kit FcCuAl 4x500kcmil/240mm ² ¹	1SDA074001R1	ZE1LUGF	1SDA074002R1	ZE1LUGF-4
E2.2	F	2000	Kit F Upper ¹	1SDA074122R1	ZE2FUF	1SDA074123R1	ZE2FUF-4
E2.2	F	2000	Kit F Lower ¹	1SDA074124R1	ZE2FLF	1SDA074125R1	ZE2FLF-4
E2.2	F	2000	Adjustable HR/VR	1SDA079850R1	ZE2HRVRFW	1SDA079851R1	ZE2HRVRFW-4
E4.2	F	3200	Kit F Upper ¹	1SDA074130R1	ZE4FUF	1SDA074131R1	ZE4FUF-4
E4.2	F	3200	Kit F Lower ¹	1SDA074132R1	ZE4FLF	1SDA074133R1	ZE4FLF-4
E4.2	F	2500	Kit Adjustable HR/VR	1SDA079860R1	ZE4HRVRFW25	1SDA079861R1	ZE4HRVRFW25-4
E4.2	F	3200	Kit VR	1SDA079866R1	ZE4VRFW32	1SDA079867R1	ZE4VRFW32
E6.2	F	6000	Kit F Upper ¹	1SDA074140R1	ZE6FUF	1SDA074141R1	ZE6FU-4
E6.2	F	6000	Kit F Lower ¹	1SDA074143R1	ZE6FLF	1SDA074144R1	ZE6FLF-4
E6.2	F	5000	Kit Adjustable HR/VR	1SDA079888R1	ZE6HRVRFW50	1SDA079889R1	ZE6HRVRFW50-4
E6.2	F	6000	Kit VR	1SDA079895R1	ZE6VRFW60	-	-
E6.2/f	F	6000	Kit F Upper ¹	-	-	1SDA074142R1	ZE6FUF-4F
E6.2/f	F	6000	Kit F Lower ¹	-	-	1SDA074145R1	ZE6FLF-4F
E6.2/f	F	5000	Kit Adjustable HR/VR	-	-	1SDA079890R1	ZE6HRVRFW50-4F

¹Not UL listed

SACE Emax 2 low voltage power circuit breakers

Accessories Terminals

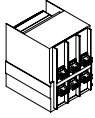

Rear orientable terminal - HR VR

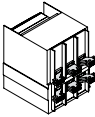

Horizontal rear terminal - SHR

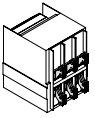

Vertical rear spread terminal - SVR

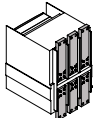

Front terminal - F

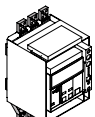

Extended front terminal - EF

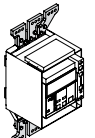

Front spread terminal - ES

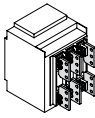

Terminal for cable FcCuAl
4x240mm² - Fc CuAl

Kit for terminals - loose supply for one side of cradle

Size	Version	Max amperage	Type	3 pieces		4 pieces	
				Global PN	US / CA PN	Global PN	US / CA PN
E1.2	W	1200	Kit EF ²	1SDA073943R1	ZE1EFW	1SDA073944R1	ZE1EFW-4
E1.2	W	1200	Kit ES ^{1,2}	1SDA073955R1	ZE1ESW	1SDA073956R1	ZE1ESW-4
E1.2	W	1200	Kit Adjustable HR/VR	1SDA079834R1	ZE1HRVRW	1SDA079835R1	ZE1HRVRW-4
E1.2	W	1200	Kit FcCuAl 4x 500kcmil/240mm ^{2 2}	1SDA073995R1	ZE1LUGW	1SDA073996R1	ZE1LUGW-4
E2.2	W	2000	Kit F Upper ²	1SDA074094R1	ZE2FUW	1SDA074095R1	ZE2FUW-4
E2.2	W	2000	Kit F Lower ²	1SDA074096R1	ZE2FLW	1SDA074097R1	ZE2FLW-4
E2.2	W	2000	Kit Adjustable HR/VR	1SDA079850R1	ZE2HRVRFW	1SDA079851R1	ZE2HRVRFW-4
E4.2	W	3200	Kit F Upper ²	1SDA074102R1	ZE4FUW	1SDA074103R1	ZE4FUW-4
E4.2	W	3200	Kit F Lower ²	1SDA074104R1	ZE4FLW	1SDA074105R1	ZE4FLW-4
E4.2	W	2500	Kit Adjustable HR/VR	1SDA079860R1	ZE4HRVRFW25	1SDA079861R1	ZE4HRVRFW25-4
E4.2	W	3200	Kit VR	1SDA079866R1	ZE4VRFW32	1SDA079867R1	ZE4VRFW32-4
E6.2	W	6000	Kit F Upper ²	1SDA074112R1	ZE6FUW	1SDA074113R1	ZE6FUW-4
E6.2	W	6000	Kit F Lower ²	1SDA074115R1	ZE6FLW	1SDA074116R1	ZE6FLW-4
E6.2	W	5000	Kit Adjustable HR/VR	1SDA079888R1	ZE6HRVRFW50	1SDA079889R1	ZE6HRVRFW50-4
E6.2	W	6000	Kit VR	1SDA079895R1	ZE6VRFW60	1SDA079896R1	-
E6.2/f	W	6000	Kit F Upper ²	-	-	1SDA074114R1	-
E6.2/f	W	6000	Kit F Lower ²	-	-	1SDA074117R1	-
E6.2/f	W	5000	Kit Adjustable HR/VR	-	-	1SDA079890R1	ZE6HRVRFW50-4F

¹ES terminals can be ordered only if the cradle also has EF terminals.

²Not UL listed

SACE Emax 2 low voltage power circuit breakers

Accessories

Spare parts Grey Platform



Ekip trip units, Grey Platform – loose supply

Size	Type	Global PN	US / CA PN
E1.2..E6.2	Ekip Dip LI	1SDA074194R1	ZEAECLI
E1.2..E6.2	Ekip Dip LSI	1SDA074195R1	ZEAECLSI
E1.2..E6.2	Ekip Dip LSI ^a	1SDA074196R1	ZEAECLSIG
E1.2..E6.2	Ekip Touch LI	1SDA074197R1	ZEATLI
E1.2..E6.2	Ekip Touch LSI	1SDA074198R1	ZEATLSI
E1.2..E6.2	Ekip Touch LSI ^a	1SDA074199R1	ZAETLSIG
E1.2..E6.2 ^a	Ekip G Touch LSI ^a	1SDA074200R1	ZEAGTLSIG
E1.2..E6.2 ^a	Ekip Hi-Touch LSI	1SDA074201R1	ZEAEHTLSI
E1.2..E6.2 ^a	Ekip Hi-Touch LSI ^a	1SDA074202R1	ZEAEHTLSIG
E1.2..E6.2 ^a	Ekip G Hi-Touch LSI ^a	1SDA074203R1	ZEAEHGLTSLIG
E1.2..E6.2 ^a	Ekip LCD LI	1SDA074204R1	ZEAECLDI
E1.2..E6.2 ^a	Ekip LCD LSI	1SDA074205R1	ZEAECLDSI
E1.2..E6.2 ^a	Ekip LCD LSI ^a	1SDA074206R1	ZEAECLDSIG
E1.2..E6.2 ^a	Ekip G LCD LSI ^a	1SDA074207R1	ZEAEGLCDLSIG
E1.2..E6.2 ^a	Ekip Hi-LCD LSI	1SDA074208R1	ZEAEHLCDLSI
E1.2..E6.2 ^a	Ekip Hi-LCD LSI ^a	1SDA074209R1	ZEAEHLCDLSIG
E1.2..E6.2 ^a	Ekip G Hi-LCD LSI ^a	1SDA074210R1	ZEAEHGLCDLSIG
E1.2..E6.2	Battery for Ekip trip units	1SDA074193R1	ZEAEKIPBAT

^aprovided without Ekip Measuring/Ekip Measuring Pro.



Measuring and Measuring Pro modules

Size	Type	Global PN	US / CA PN
E1.2	Ekip Measuring	1SDA074184R1	ZE1MEEAS
E1.2	Ekip Measuring Pro	1SDA074185R1	ZE1MEEASPRO
E2.2	Ekip Measuring	1SDA074186R1	ZE2MEEAS
E2.2	Ekip Measuring Pro	1SDA074187R1	ZE2MEEASPRO
E4.2	Ekip Measuring	1SDA074188R1	ZE4MEEAS
E4.2	Ekip Measuring Pro	1SDA074189R1	ZE4MEEASPRO
E6.2	Ekip Measuring	1SDA074190R1	ZE6MEEAS
E6.2	Ekip Measuring Pro	1SDA074191R1	ZE6MEEASPRO
E1.2 ^c	Voltage socket for neutral on right side L1 L2 L3 N - E1.2	1SDA076244R1	ZE1VSNRT
E2.2 ^c	Voltage socket for neutral on right side L1 L2 L3 N - E2.2	1SDA076245R1	ZE2VSNRT
E4.2 ^c	Voltage socket for neutral on right side L1 L2 L3 N - E4.2	1SDA076246R1	ZE4VSNRT
E6.2 ^c	Voltage socket for neutral on right side L1 L2 L3 N - E6.2	1SDA076247R1	ZE6VSNRT

^cuse only with circuit breakers with neutral on right side L1 L2 L3 N

Signalling modules

Size	Type	Global PN	US / CA PN
E2.2..E6.2	Ekip 4K	1SDA114475R1	ZE44K

SACE Emax 2 low voltage power circuit breakers

Accessories

Spare parts Grey Platform



Rating plug for Ekip trip units

Size	Type	Global PN (loose supply)	US / CA PN (loose supply)
E1.2..E2.2	Rating Plug 100A	1SDA074218R1	ZEA0100RP
E1.2..E2.2	Rating Plug 200A	1SDA074219R1	ZEA0200RP
E1.2..E2.2	Rating Plug 250A	1SDA074220R1	ZEA0250RP
E1.2..E6.2	Rating Plug 400A	1SDA074221R1	ZEA0400RP
E1.2..E6.2	Rating Plug 600A ¹	1SDA082038R1	ZEA0600RP
E1.2..E6.2	Rating Plug 800A	1SDA074223R1	ZEA0800RP
E1.2..E6.2	Rating Plug 1000A	1SDA074224R1	ZEA1000RP
E1.2..E6.2	Rating Plug 1200A ¹	1SDA079730R1	ZEA1200RP
E1.2..E6.2	Rating Plug 1600A ²	1SDA074226R1	ZEA1600RP
E2.2..E6.2	Rating Plug 2000A	1SDA074227R1	ZEA2000RP
E2.2..E6.2	Rating Plug 2500A ³	1SDA074228R1	ZEA2500RP
E4.2..E6.2	Rating Plug 3200A	1SDA074229R1	ZEA3200RP
E4.2..E6.2	Rating Plug 3600A ¹	1SDA079827R1	ZEA3600RP
E4.2..E6.2	Rating Plug 4000A ⁴	1SDA074230R1	ZEA4000RP
E6.2	Rating Plug 5000A	1SDA074231R1	ZEA5000RP
E6.2	Rating Plug 6000A ¹	1SDA079731R1	ZEA6000RP

¹UL only

²IEC only for E1.2, both UL and IEC for all other frames

³IEC only for E2.2, both UL and IEC for E4.2 and E6.2

⁴IEC only for E4.2, both UL and IEC for E6.2

SACE Emax 2 low voltage power circuit breakers

Accessories

Service



—
Note:
Warranty periods are measured from the date the circuit breaker leaves the factory.

Extended warranty

Size	Type	Global PN ^c	US / CA PN
E1.2...E6.2	Warranty 2 years E1.2...E6.2 ^a	1SDA082413R1	Factory installed
E1.2	Warranty 4 years E1.2 ^b	1SDA082414R1	Factory installed
E2.2	Warranty 4 years E2.2 ^b	1SDA082415R1	Factory installed
E4.2	Warranty 4 years E4.2 ^b	1SDA082416R1	Factory installed
E6.2	Warranty 4 years E6.2 ^b	1SDA082417R1	Factory installed
E1.2	Warranty 5 years E1.2 ^b	1SDA082418R1	Factory installed
E2.2	Warranty 5 years E2.2 ^b	1SDA082419R1	Factory installed
E4.2	Warranty 5 years E4.2 ^b	1SDA082420R1	Factory installed
E6.2	Warranty 5 years E6.2 ^b	1SDA082421R1	Factory installed

The registration in the Extended Warranty online tool is mandatory

^aFree-of-charge with site details entered

^bWarranty durations:

- 4 years when site details not entered into the Extended Warranty online tool
- 5 years when site details entered into the Extended Warranty online tool

^cOrder only with the circuit breaker. Specify Registration code in the order to activate the warranty.

SACE Emax 2 low voltage power circuit breakers

Accessories

Spare parts

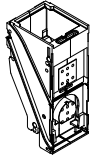

Single phase pole

Size	Poles	IEC/UL	Version	Global PN	Type spare	Min quantity
E2.2 - Iu≤2000A	3p; 4p	IEC	F; W (MP)	1SDA081187R1	A	3 or 4
E2.2 - Iu=2500A	3p; 4p	IEC	F; W (MP)	1SDA081188R1	A	3 or 4
E4.2	3p; 4p	IEC	F; W (MP)	1SDA081189R1	A	3 or 4
E6.2 - Half phase	3p; 4p; 4p/f	IEC	F; W (MP)	1SDA081190R1	A	6 or 7 or 8

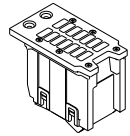

Arching chamber

Size	Poles	IEC/UL	Version	Global PN	Type spare	Min quantity
E2.2	3p; 4p	IEC	F; W (MP)	1SDA081430R1	-	3 or 4
E4.2; E6.2	3p; 4p	IEC	F; W (MP)	1SDA081431R1	-	3 or 4 for E4.2, 6 or 7 or 8 for E6.2

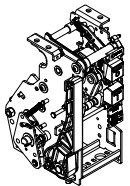

Operating mechanism^a

Size	Poles	IEC/UL	Version	Global PN	Type spare	Min quantity
E2.2	3p; 4p	IEC/UL	F; W (MP)	1SDA081191R1	A	1
E4.2	3p; 4p	IEC/UL	F; W (MP)	1SDA081192R1	A	1
E6.2	3p; 4p	IEC/UL	F; W (MP)	1SDA081193R1	A	1
E6.2	4p/f	IEC/UL	F; W (MP)	1SDA081194R1	A	1

^aAdd closing spring

Closing Spring

Size	Poles	IEC/UL	Version	Global PN	Type spare	Min quantity
E2.2 - Iu≤2000A	3p	IEC/UL	F; W (MP)	1SDA081207R1	A	1
E2.2 - Iu≤2000A	4p	IEC/UL	F; W (MP)	1SDA081208R1	A	1
E2.2 - Iu=2500A; E4.2	3p	IEC/UL	F; W (MP)	1SDA081208R1	A	1
E2.2 - Iu=2500A; E4.2	4p	IEC/UL	F; W (MP)	1SDA081209R1	A	1
E6.2	3p	IEC/UL	F; W (MP)	1SDA081210R1	A	1
E6.2	4p; 4p/f	IEC/UL	F; W (MP)	1SDA081211R1	A	1

—
Min quantity = min quantity to complete a circuit- breaker: The quantity is related to the number of phases (3 or 4 polese) of the circuit- breaker (E6.2 has half phases so quantities are double).
Type A Spare part = only for ABB L3 technicians



Spring Charging lever

Size	Poles	IEC/UL	Version	Global PN	Type spare	Min quantity
E2.2; E4.2; E6.2	3p; 4p	IEC/UL	F; W (MP)	1SDA081217R1	A	1

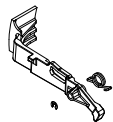

Signalling charged spring lever

Size	Poles	IEC/UL	Version	Global PN	Type spare	Min quantity
E2.2; E4.2; E6.2	3p; 4p	IEC/UL	F; W (MP)	1SDA081242R1	A	1

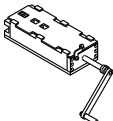

Spring charging device

Size	Poles	IEC/UL	Version	Global PN	Type spare	Min quantity
E2.2; E4.2; E6.2	3p; 4p	IEC	F; W(MP)	1SDA082230R1	A	1

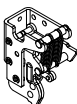

Tripping mechanism

Size	Poles	IEC/UL	Version	Global PN	Type spare	Min quantity
E2.2; E4.2; E6.2	3p; 4p	IEC	F; W (MP)	1SDA082187R1	A	1

SACE Emax 2 low voltage power circuit breakers

Accessories
Spare parts



Fixing screws kit - 50 pcs

Size	Poles	IEC/UL	Version	Global PN	Type spare	Min quantity
E1.2 - wall mounted	3p; 4p	IEC/UL	F	1SDA081179R1	-	1
E1.2 - floor mounted	3p; 4p	IEC/UL	F	1SDA081413R1	-	1
E1.2 - floor mounted	3p; 4p	IEC/UL	W (FP)	1SDA081414R1	-	1
E2.2; E4.2; E6.2	3p; 4p	IEC/UL	F; W (FP)	1SDA081467R1	-	1

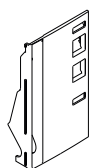

Safety cover

Size	Poles	IEC/UL	Version	Global PN	Type spare	Min quantity
E1.2	3p; 4p	IEC/UL	F; W (MP)	1SDA081402R1	-	1
E2.2; E4.2; E6.2	3p; 4p	IEC/UL	F; W (MP)	1SDA081432R1	-	1

For each part ordered, specify the Serial number of the circuit-breaker it is intended for.

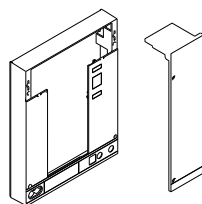

Accessories cover ^{b)}

Size	Poles	IEC/UL	Version	Global PN	Type spare	Min quantity
E1.2	3p	IEC/UL	F; W (MP)	1SDA081403R1	-	1
E1.2	4p	IEC/UL	F; W (MP)	1SDA081404R1	-	1
E2.2	3p	IEC/UL	F	1SDA081433R1	-	1
E2.2	4p	IEC/UL	F	1SDA081434R1	-	1
E2.2	3p	IEC/UL	W (MP)	1SDA081435R1	-	1
E2.2	4p	IEC/UL	W (MP)	1SDA081436R1	-	1
E4.2	3p	IEC/UL	F	1SDA081437R1	-	1
E4.2	4p	IEC/UL	F	1SDA081438R1	-	1
E4.2	3p	IEC/UL	W (MP)	1SDA081439R1	-	1
E4.2	4p	IEC/UL	W (MP)	1SDA081440R1	-	1
E6.2	3p	IEC/UL	F	1SDA081441R1	-	1
E6.2	4p	IEC/UL	F	1SDA081442R1	-	1
E6.2	3p	IEC/UL	W (MP)	1SDA081443R1	-	1
E6.2	4p	IEC/UL	W (MP)	1SDA081444R1	-	1
E6.2	4p/f	IEC/UL	F	1SDA081445R1	-	1
E6.2	4p/f	IEC/UL	W (MP)	1SDA081446R1	-	1
E1.2 - Castell ^a	3p; 4p	IEC	F; W (MP)	1SDA082145R1	-	1
E2.2...E6.2 - Castell ^a	3p; 4p	IEC	F	1SDA082146R1	-	1
E2.2...E6.2 - Castell ^a KLC	3p; 4p	IEC	W (MP)	1SDA082149R1	-	1
E2.2...E6.2 - Castell ^a KLC+ KLP	3p; 4p	IEC	W (MP)	1SDA082150R1	-	1
E2.2...E6.2 - Castell ^a KLP	3p; 4p	IEC	W (MP)	1SDA082151R1	-	1

^aThe lock is not included; ^{b)} TU Reset not included. Use the existing one.

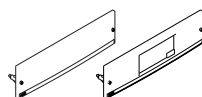

Transparent cover for trip unit

Size	Poles	IEC/UL	Version	Global PN	Type spare	Min quantity
E1.2 DIP	3p; 4p	IEC/UL	F; W (MP)	1SDA081405R1	-	1
E1.2 Touch	3p; 4p	IEC/UL	F; W (MP)	1SDA081406R1	-	1
E2.2; E4.2; E6.2 DIP	3p; 4p	IEC/UL	F; W (MP)	1SDA081447R1	-	1
E2.2; E4.2; E6.2 Touch	3p; 4p	IEC/UL	F; W (MP)	1SDA081448R1	-	1

Type A Spare part = only for ABB L3 technicians

SACE Emax 2 low voltage power circuit breakers

Accessories

Spare parts

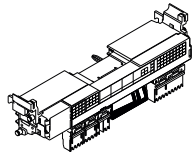

Sliding contact for Moving Part

Size	Poles	IEC/UL	Version	Global PN	Type spare	Min quantity
E1.2	3p	IEC/UL	W (MP)	1SDA081167R1	-	1
E1.2	4p	IEC/UL	W (MP)	1SDA081168R1	-	1
E2.2; E4.2; E6.2	3p; 4p	IEC/UL	W (MP)	1SDA081212R1	-	1
E2.2; E4.2; E6.2 - MS	3p; 4p	IEC/UL	W (MP)	1SDA081213R1	-	1

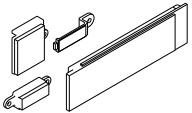

Kit front cover plugs

Size	Poles	IEC/UL	Version	Global PN	Type spare	Min quantity
E1.2	3p; 4p	IEC/UL	F; W (MP)	1SDA081415R1	-	1
E2.2; E4.2; E6.2	3p; 4p	IEC/UL	F; W (MP)	1SDA081471R1	-	1

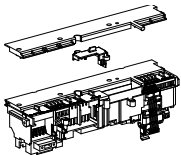

Terminal box connection interface

Size	Poles	IEC/UL	Version	Global PN	Type spare	Min quantity
E1.2	3p; 4p	IEC/UL	F	1SDA081409R1	A	1
E2.2; E4.2; E6.2	3p; 4p	IEC/UL	F; W (MP)	1SDA081451R1	A	1
E2.2; E4.2; E6.2 - MS	3p; 4p	IEC/UL	F; W (MP)	1SDA081452R1	A	1

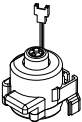

Trip coil

Size	Poles	IEC/UL	Version	Global PN	Type spare	Min quantity
E1.2	3p; 4p	IEC/UL	F; W (MP)	1SDA081407R1	-	1
E2.2; E4.2; E6.2	3p; 4p	IEC/UL	F; W (MP)	1SDA081449R1	-	1

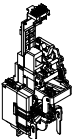

Right plate for accessories (Right MID)

Size	Poles	IEC/UL	Version	Global PN	Type spare	Min quantity
E2.2; E4.2; E6.2	3p; 4p	IEC/UL	F; W (MP)	1SDA081214R1	A	1
E2.2; E4.2; E6.2 - MS	3p; 4p	IEC/UL	F; W (MP)	1SDA081215R1	A	1

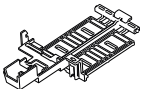

Cover for right plate for accessories (Right MID Cover)

Size	Poles	IEC/UL	Version	Global PN	Type spare	Min quantity
E2.2; E4.2; E6.2	3p; 4p	IEC/UL	F; W (MP)	1SDA081466R1	-	1

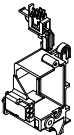

Left plate for accessories (Left MID)

Size	Poles	IEC/UL	Version	Global PN	Type spare	Min quantity
E1.2	3p; 4p	IEC/UL	F; W (MP)	1SDA081170R1	-	1
E2.2; E4.2; E6.2	3p; 4p	IEC/UL	F; W (MP)	1SDA081453R1	-	1

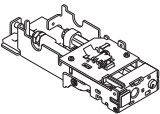

Racked in and out device (CD)

Size	Poles	IEC/UL	Version	Global PN	Type spare	Min quantity
E2.2; E4.2; E6.2	3p; 4p	IEC/UL	W (MP)	1SDA081216R1	A	1



CD lock lever

Size	Poles	IEC/UL	Version	Global PN	Type spare	Min quantity
E2.2; E4.2; E6.2	3p; 4p	IEC/UL	W (MP)	1SDA081256R1	A	1

SACE Emax 2 low voltage power circuit breakers

Accessories
Spare parts

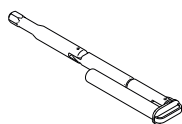

Racking in and out lever

Size	Poles	IEC/UL	Version	Global PN	Type spare	Min quantity
E1.2	3p; 4p	IEC/UL	W (MP)	1SDA081410R1	-	1
E2.2; E4.2; E6.2	3p; 4p	IEC/UL	W (MP)	1SDA081455R1	-	1

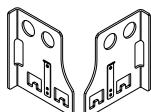

Lifting plates

Size	Poles	IEC/UL	Version	Global PN	Type spare	Min quantity
E2.2; E4.2; E6.2	3p; 4p	IEC/UL	F; W (MP)	1SDA081454R1	-	1

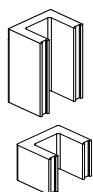

Moving part terminals

Size	Poles	IEC/UL	Version	Global PN	Type spare	Min quantity
E2.2 - Iu≤2000A	3p; 4p	IEC	W (MP)	1SDA081243R1	A	3 or 4
E2.2 - Iu=2500A	3p; 4p	IEC	W (MP)	1SDA081244R1	A	3 or 4
E4.2 - Iu≤3200A	3p; 4p	IEC	W (MP)	1SDA081245R1	A	3 or 4
E4.2 - Iu=4000A	3p; 4p	IEC	W (MP)	1SDA081246R1	A	3 or 4
E6.2	3p; 4p/f	IEC	W (MP)	1SDA081247R1	A	6 or 7 or 8

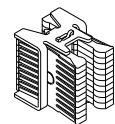

Jaw contacts

Size	Poles	IEC/UL	Version	Global PN	Type spare	Min quantity
E1.2	3p; 4p	IEC	W (FP)	1SDA081164R1	A	3 or 4
E2.2 - Iu≤2000A	3p; 4p	IEC	W (FP)	1SDA081195R1	A	3 or 4
E2.2 - Iu=2500A	3p; 4p	IEC	W (FP)	1SDA081196R1	A	3 or 4
E4.2 - Iu≤3200A	3p; 4p	IEC	W (FP)	1SDA081197R1	A	3 or 4
E4.2 - Iu=4000A	3p; 4p	IEC	W (FP)	1SDA081198R1	A	3 or 4
E6.2	3p; 4p; 4p/f	IEC	W (FP)	1SDA081199R1	A	6 or 7 or 8

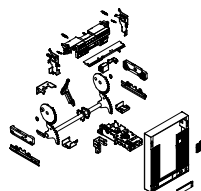

Conversion kit from Fixed to Moving part *

Size	Poles	IEC/UL	Version	Global PN	Type spare	Min quantity
E1.2	3p	IEC	F	1SDA081176R1	A	1
E1.2	4p	IEC	F	1SDA081177R1	A	1
E2.2	3p	IEC	F	1SDA081234R1	A	1
E2.2	4p	IEC	F	1SDA081235R1	A	1
E4.2	3p	IEC	F	1SDA081236R1	A	1
E4.2	4p	IEC	F	1SDA081237R1	A	1
E6.2	3p	IEC	F	1SDA081238R1	A	1
E6.2	4p	IEC	F	1SDA081239R1	A	1
E6.2	4p/f	IEC	F	1SDA081240R1	A	1

For each part ordered, specify the Serial number of the circuit-breaker it is intended for; * moving part terminals not included

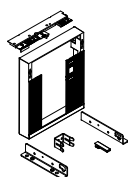

Conversion kit from Moving Part into Fixed version *

Size	Poles	IEC/UL	Version	Global PN	Type spare	Min quantity
E1.2 - wall mounted	3p; 4p	IEC/UL	W (MP)	1SDA081178R1	A	1
E1.2 - floor mounted	3p; 4p	IEC/UL	W (MP)	1SDA082303R1	A	1
E2.2; E4.2; E6.2	3p; 4p	IEC/UL	W (MP)	1SDA081241R1	A	1

For each part ordered, it is mandatory to specify the Serial number of the circuit-breaker it is intended for; * Standard terminals not included

Type A Spare part = only for ABB L3 technicians

SACE Emax 2 low voltage power circuit breakers

Accessories

Spare parts

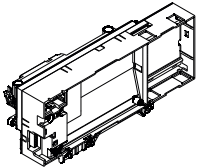

Main board

Size	Poles	IEC/UL	Version	Global PN	Type spare	Min quantity
E1.2	3p; 4p	IEC/UL	F; W (MP)	1SDA081408R1	-	1
E2.2; E4.2; E6.2	3p; 4p	IEC/UL	F; W (MP)	1SDA081450R1	-	1

For each part ordered, it is mandatory to specify the Serial number of the circuit-breaker it is intended for.



Trip Unit Battery

Size	Poles	IEC/UL	Version	Global PN	Type spare	Min quantity
E1.2; E2.2; E4.2; E6.2	3p; 4p	IEC/UL	F; W (MP)	1SDA074193R1	-	1

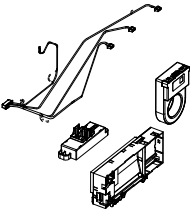

Main board + Sensors + cables

Size	Poles	IEC/UL	Version	Global PN	Type spare	Min quantity
E2.2	3p	IEC/UL	F; W (MP)	1SDA081200R1	A	1
E2.2	4p	IEC/UL	F; W (MP)	1SDA081201R1	A	1
E4.2	3p	IEC/UL	F; W (MP)	1SDA081202R1	A	1
E4.2	4p	IEC/UL	F; W (MP)	1SDA081203R1	A	1
E6.2	3p	IEC/UL	F; W (MP)	1SDA081204R1	A	1
E6.2	4p	IEC/UL	F; W (MP)	1SDA081205R1	A	1
E6.2	4p/f	IEC/UL	F; W (MP)	1SDA081206R1	A	1

For each part ordered, it is mandatory to specify the Serial number of the circuit-breaker it is intended for.

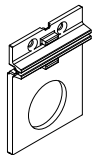

Sensors plastic covers

Size	Poles	IEC/UL	Version	Global PN	Type spare	Min quantity
E2.2	3p; 4p	IEC/UL	F; W (MP)	1SDA081468R1	-	1
E4.2	3p; 4p	IEC/UL	F; W (MP)	1SDA081469R1	-	1
E6.2	3p; 4p; 4p/f	IEC/UL	F; W (MP)	1SDA081470R1	-	1

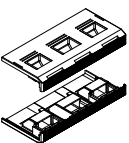

Terminal covers

Size	Poles	IEC/UL	Version	Global PN	Type spare	Min quantity
E1.2	3p	IEC/UL	W (MP)	1SDA081182R1	-	1
E1.2	4p	IEC/UL	W (MP)	1SDA081183R1	-	1

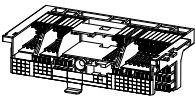

Terminal box fixed part

Size	Poles	IEC/UL	Version	Global PN	Type spare	Min quantity
E1.2	3p; 4p	IEC/UL	W (FP)	1SDA081180R1	A	1
E2.2; E4.2	3p; 4p	IEC	W (FP)	1SDA082152R1	A	1
E6.2	3p; 4p; 4p/f	IEC	W (FP)	1SDA082153R1	A	1

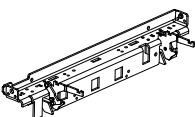

Support for terminal box of Fixed Part

Size	Poles	IEC/UL	Version	Global PN	Type spare	Min quantity
E1.2	3p	IEC/UL	W (FP)	1SDA082237R1	A	1
E1.2	4p	IEC/UL	W (FP)	1SDA082238R1	A	1
E2.2	3p	IEC/UL	W (FP)	1SDA081249R1	A	1
E2.2	4p	IEC/UL	W (FP)	1SDA081250R1	A	1
E4.2	3p	IEC/UL	W (FP)	1SDA081251R1	A	1
E4.2	4p	IEC/UL	W (FP)	1SDA081252R1	A	1
E6.2	3p	IEC/UL	W (FP)	1SDA081253R1	A	1
E6.2	4p	IEC/UL	W (FP)	1SDA081254R1	A	1
E6.2	4p/f	IEC/UL	W (FP)	1SDA081255R1	A	1

— Type A Spare part = only for ABB L3 technicians

SACE Emax 2 low voltage power circuit breakers

Accessories

Spare parts

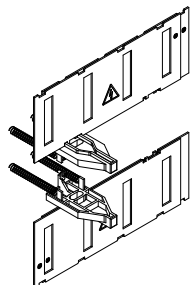

Safety shutters for fixed part

Size	Poles	IEC/UL	Version	Global PN	Type spare	Min quantity
E1.2	3p	IEC	W (FP)	1SDA081411R1	-	1
E1.2	4p	IEC	W (FP)	1SDA081412R1	-	1
E2.2	3p	IEC	W (FP)	1SDA081457R1	-	1
E2.2	4p	IEC	W (FP)	1SDA081458R1	-	1
E4.2	3p	IEC	W (FP)	1SDA081459R1	-	1
E4.2	4p	IEC	W (FP)	1SDA081460R1	-	1
E6.2	3p	IEC	W (FP)	1SDA081461R1	-	1
E6.2	4p	IEC	W (FP)	1SDA081462R1	-	1
E6.2	4p/f	IEC	W (FP)	1SDA081463R1	-	1

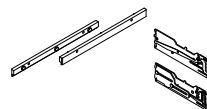

Lateral guides for fixed part

Size	Poles	IEC/UL	Version	Global PN	Type spare	Min quantity
E2.2; E4.2; E6.2	3p; 4p	IEC	W (FP)	1SDA082154R1	A	1

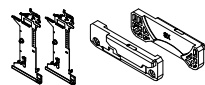

Lateral guides for Moving part

Size	Poles	IEC/UL	Version	Global PN	Type spare	Min quantity
E1.2	3p; 4p	IEC	W (MP)	1SDA082188R1	-	1
E2.2; E4.2; E6.2	3p; 4p	IEC	W (MP)	1SDA082302R1	-	1

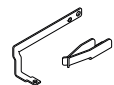

Earth sliding contact for Fixed Part

Size	Poles	IEC/UL	Version	Global PN	Type spare	Min quantity
E2.2; E4.2; E6.2	3p; 4p	IEC/UL	W (FP)	1SDA081465R1	-	1

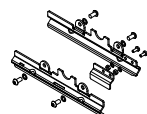

Safety cover

Size	Poles	IEC/UL	Version	Global PN	Type spare	Min quantity
E2.2; E4.2; E6.2	3p; 4p	IEC/UL	W (MP)	1SDA081464R1	-	1

—
Type A Spare part = only
for ABB L3 technicians

The complete ordering codes for original and guaranteed spare parts are available in the ABB SACE Spare Parts Catalog – 1SDC001007D0204.

EntelliGuard™ G low voltage power circuit breaker

Overview and functions

EntelliGuard™ G Circuit Breakers

EntelliGuard™ G Circuit Breakers are the newest top of the line circuit breakers designed to meet the demands of today's electrical distribution systems by providing ultimate system performance without sacrificing safety or reliability.

EntelliGuard™ G devices are available in standard, 100% rated, ANSI/UL1066, UL489 and IEC ratings. Breakers are offered to OEMs in 3 and 4 pole designs from 400A to 6000A (UL/ANSI) or up to 6300A (IEC) with fault interruption ratings up to 150kA and many fieldinstallable accessories. EntelliGuard™ G 3-pole breakers are the standard in ABB AKD-20 Low Voltage Switchgear suitable for 280Vac and 600Vac. The breakers are suitable for 280Vac, 480Vac and 600Vac applications, and they provide advanced circuit protection, limit arc fault energy and preserve system coordination without sacrificing any of these critical functions.



Standard Functions

The EntelliGuard™ G Circuit Breakers offer operational safety with functions such as:

- **Closing and opening** - can be initiated remotely or via the front cover push buttons. An Open-Close-Open cycle is possible without recharging.
- **Breaker/Main Contact Status** - OPEN/CLOSED, ON/OFF indication is provided on the front cover.
- **Through-Door Racking** - The breaker racking mechanism is accessible through the front door and permits safely disconnecting/ withdrawing the circuit breaker without opening the door and exposing personnel to live parts during the process.
- **Ready to Close Indicator** - Provides visible indication/ readiness for close operation.
- **Breaker Status Indicators** - Standard Indicators include:
 - The breaker status indicator shows the condition of the main contacts (OPEN, CLOSED).
 - The status of the closing springs is indicated as CHARGED or DISCHARGED.
 - The draw-out position indicator displays whether the breaker is in the CONNECT, TEST or DISCONNECT position.
 - The breaker also includes a switch that provides main contact status indication to the POWER LEADER™ Power Management System.
 - The optional Reduced Energy Let-Through (RELT) is provided with an ON/OFF contact closure to positively indicate whether the RELT setting is enabled or not.
- **Rejection Feature** - A factory-installed rejection feature prevents mismatching breakers and cassettes/ substructures.
- **EntelliGuard™ G breakers are designed for flexibility and superiority with functions such as:**
 - **Short Time Rating** - Up to 100kA for 0.5 sec.
 - **Short Circuit/High Interruption Rating** - 150kA at 600V, 100kA at 690V.
- **Two-Step Stored Energy Mechanism** - Breaker operates via stored energy mechanisms that can be manually charged (MO) or electrically charged (EO) by the Spring Charging Motor. Closing time is less than five cycles.
- **Reverse Feed** - EntelliGuard™ G devices can be fed from top or bottom terminals.
- **Coils** - EntelliGuard™ G devices have provisions for four accessory operating coils. The four positions can be filled by the following four devices: one Close Coil (CC or CCC), one Shunt Trip Coil, one UVR (Under Voltage Release), and the fourth position can either be a Shunt Trip Coil or a UVR.
- **Motor Operator Heavy Duty, Motor/Gearbox Unit** - easily accessible.
- **Interlocks** - Standard interlocks include:
 - Drawout Breaker
 - Drawout Breaker/Main Contacts
 - Spring Discharge Interlock
- **Padlocking Devices** - The padlocking device is standard on breakers and allows up to three padlocks with 1/4" to 3/8" diameter shanks to secure the breaker in the OPEN/TRIP FREE position.
- **Thermal Performance** - ANSI C37 and UL 489 designs are 100% rated up to 40°C when applied in recommended enclosure sizes. IEC 60947 versions are 100% rated in free air up to 50°C. IP31 enclosure/switchboard rating is based on size, recommended up to 50°C ambient with rear vertical bus connection.
- **Field Installable Trip Units and Accessories Field** - installable accessories are common to all breaker envelopes and frames. Optionally, accessories are also factory mountable.

EntelliGuard™ G low voltage power circuit breaker Functions

Optional Functions

EntelliGuard™ G Circuit Breakers offer many optional functions in order to enhance and facilitate the use of the circuit breaker. Those functions include:

- **Auxiliary Switches** - (Optional) Four available designs:
 - Power rated (3NO+3NC)
 - Power rated (3NO+3NC) + low signal (Hi-Fi) (2NO+2NC)
 - Power rated (8NO+8NC)
 - Power rated (4NO+4NC) + low signal (Hi-Fi) (4NO+4NC)
- **Key Interlock** - Up to four optional key interlocks are available (Kirk, Ronis, Profalux, Castell). Switchgear applications utilize a Kirk key interlock mounted in the cassette. A maximum of two key interlocks may fit in the cassette.
- **Mounting Straps/Accessories Kits** - are available to mount and connect fixed/stationary breakers.
- **Optional Lockable Shutters** - are available (factory installed).
- **Carriage Position Switch** - This optional cassette/substructure device permits local or remote indication of the circuit breaker status (CONNECTED, TEST, DISCONNECTED), 2NO/2NC single pole, double throw contacts are available for each position.
- **Lifting Truck** - Optional lifting tool with separate slings is available for all breaker sizes.
- **Optional IP Covers** - IP54 covers (protected against harmful amounts of dust and splashing water) are available for all breaker sizes.
- **Mechanical Counter** - Provides local record of the cumulative number of complete breaker closing operations.
- **Cable Interlocks** - (OEM Applications Only) Available for fixed and draw-out breakers, these units enable direct interlocking of EntelliGuard™ G circuit breakers.
- **Bell Alarm Contact** - Available with or without a mechanical lockout feature, the bell alarm operates when the trip unit issues a trip command.



EntelliGuard™ G circuit breakers with EntelliGuard trip units can be part of an ArcWatch™ solution.

ABB's ArcWatch™ system solution involves a combination of intelligent trip units and current limiting molded case circuit breakers to create a no compromise solution; safety and reliability together. Advances in zone selective interlocking (ZSI) and waveform recognition algorithms allow entire systems to be designed so that full selectivity and 100% instantaneous protection at calculated arcing current is possible. For most industrial systems, the ABB ArcWatch™ solution will result in incident energy under 8 cal/cm² at 18".

Enabling ArcWatch™ means the proper coordination analysis techniques have been used to determine the necessary circuit breaker protection features and settings that allow full coordination in the given system. The circuit breaker must be set to match the results of the completed study.

For more information, check out electrification.us.abb.com/ArcWatch (Publication 1SDC210066D0201) or contact your local sales representative.

EntelliGuard™ G low voltage power circuit breaker

EntelliGuard™ TU trip units

EntelliGuard™ TU Trip Units

EntelliGuard™ TU Trip Units enable the EntelliGuard™ G circuit breaker with advanced technology and superior circuit protection without compromising selectivity or arc flash protection. EntelliGuard™ TU series trip units are available as the standard controller for new production EntelliGuard™ G ANSI/UL 1066, UL 489 and IEC circuit breakers.

These cutting edge trip units provide Zone Selective Instantaneous Protection, Waveform capture, Reduced Energy Let Through Instantaneous Trip and are designed to supply communications for Modbus or Profibus protocols.

Note: See page 8-111 for more information about the EntelliGuard™ TU Trip Unit.

Accessories

There are more than 20 different types of factory or field installed accessories available for the EntelliGuard™ G circuit breaker. Whether it's a bell alarm contact, key interlock or redundant shunt trips, ABB has the accessory combinations to meet your need!

Factory-Installed Accessories

- Motor Operators
- Closing Devices
- Shunt Trip for Ground Fault
- UVR with Fixed Time Delay
- Second Shunt Trip or UV Release
- Auxiliary Switches and Contacts
- Bell Alarm and Trip Annunciation
- Bell Alarm Contact
- Trip Annunciation
- Breaker Mounted Key Interlocks
- Mechanical Interlocks- Fixed Breakers
- Mechanical Interlocks – Drawout Breakers

Accessories for Field Installation

- Carriage Position Switch
- Coil Signaling Contact Module
- Contact Wear Indicator
- Door Interlock
- Electrical Close Switch
- Lock Kits
- Lifting Truck
- Mechanical Operation Counter
- Pushbutton Padlock Device
- Ready-to-Close Switch
- Secondary Disconnect Block
- Spring Charged Contact
- UVR Time Delay Module

Note: See page 8-98 for more information about the accessories available for EntelliGuard™ G Circuit Breakers.



EntelliGuard™ G circuit breaker

EntelliGuard™ G circuit breaker nomenclature

EntelliGuard™ G Circuit Breaker Product Number Structure

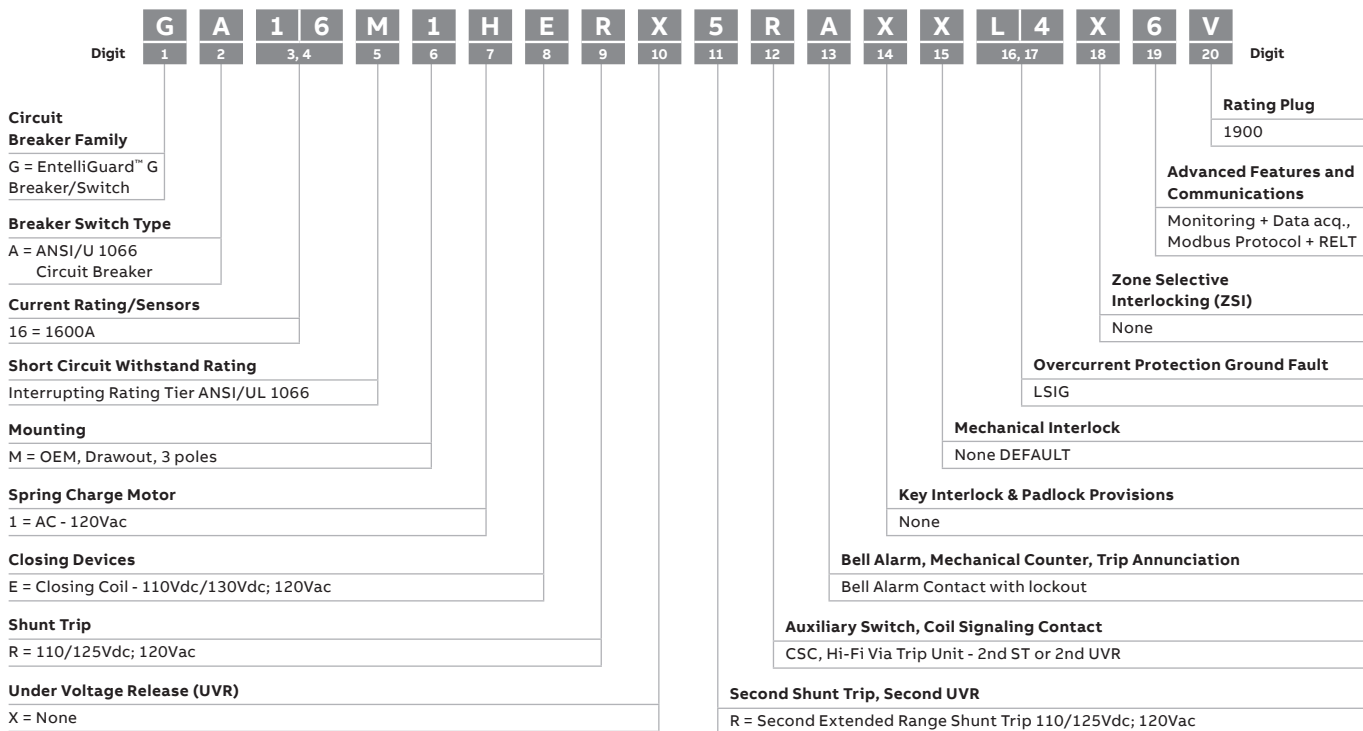

Digit 1 Circuit Breaker Family

Device Series Line	Code
EntelliGuard™ G Breaker/Switch	G

Digit 2 Breaker Switch Type

Breaker/Switch Type, Secondary Mounting	Envelope 1		Envelope 2 & 3
	Side	Top	Top
ANSI/UL1066 Circuit Breaker	A	N	A
UL 489 Circuit Breaker	B	U	B
ANSI Non-auto CB (ANSI Switch)	C	M	C
UL489 Non-auto CB (UL Switch)	D	S	D

Top = Top Mounted Secondary Disconnects (TSD).

Side = Side Mounted Secondary Disconnects (SSD). (Available on Envelope 1 only.)

NOTE: N, U, M, S characters are for Envelope 1 only with top mounted secondary disconnects (TSD).

When ordering codes A, B, C, D, Side Secondary Disconnects (SSD) are supplied as standard on Envelope 1.

Codes N, U, M, S are not valid for Envelopes 2 and 3.

Envelope 1 (Type N and H, 400A - 2000A).

NOTE: DC Ratings; trip unit not included. DC Rated Circuit Breakers require external control devices (e.g., Type 37 or Type 76 DC Relays).

NOTE: Side Secondary Disconnects are specifically intended for 5-High ("high density") equipment designs.

With Side Mounted Disconnects (SSD), the following Aux. Switches are not valid (In Digit 12); Auxiliary Switch, 8NO+8NC (Power Rated) or Aux. Switch, 4NO/4NC (Power Rated) + 4NO/4NC (High Fidelity).

Digits 3 and 4 Current Rating /Sensors

Current Sensor Rating (A)	Circuit Breaker		Switches ¹	
	ANSI	UL489	ANSI	UL489
400	04	04	-	-
600	-	06	-	-
800	08	08	08	08
1000	-	10	-	-
1200	-	12	-	12
1600	16	16	16	16
2000	20	20	20	20
2500	-	25	-	25
3000	-	30	-	30
3200	32	-	32	-
4000	40	40	40	40
5000	50	50	50	50
6000	-	60	-	60

¹Switches (Digit 2 = M, S, C, D) do not have current Sensors or a trip unit

EntelliGuard™ G circuit breaker

EntelliGuard™ G circuit breaker nomenclature

Digit 5 Short Circuit Withstand Ratings

Interrupting Rating Tier ANSI/UL1066 Devices, LVPCB								Envelope 1		Envelope 2		Envelope 3		
Code	254V	580V	635V	1/2S Withstand	HSIOC	Override No. 1	Override WI	Code	400-1200	400-2000	3200	400-3200	3200	4000-5000
S	65,000	65,000	50,000	50,000	50,000	49,000	53,500	S	.					
N	65,000	65,000	65,000	65,000	None	None	None	N		.	.			
H	85,000	85,000	65,000	65,000	65,000	63,700	69,500	H		.				
P ²	100,000	100,000	65,000	65,000	65,000	63,700	69,550	P		.				
E	85,000	85,000	85,000	85,000	None	None	None	E				.		
M	100,000	100,000	100,000	85,000	85,000	83,800	90,950	M				.		.
B	100,000	100,000	100,000	100,000	None	None	None	B					.	.
L	150,000	150,000	100,000	100,000	100,000	98,000	107,000	L					.	.

Interrupting Rating Tier UL489 Devices ICCB								Envelope 1		Envelope 2		Envelope 3		
Code	240V	480V	600V	1/2S Withstand	HSIOC	Override No. 1	Override WI	Code	400-1200	400-2000	2500-3000	400-3000	3000	4000-6000
S	65,000	65,000	50,000	42,000	42,000	N/A	44,940	S	.					
N	65,000	65,000	65,000	42,000	42,000	N/A	44,940	N		.	.			
H	85,000	85,000	65,000	50,000	50,000	N/A	53,500	H		.	.			
P ²	100,000	100,000	65,000	50,000	50,000	N/A	53,500	P		.				
M	100,000	100,000	100,000	65,000	65,000	N/A	69,550	M				.		.
L	150,000	150,000	100,000	85,000	85,000	N/A	90,950	L					.	.

Close and Latch Ratings (MCR set accordingly)

UL/ANSI 1	42,000	UL/ANSI CB MCR setting determined base on Envelope only. For Retrofill's (A = 17,000, B = 33,000, N = 42,000)										
UL/ANSI 2	65,000											
UL/ANSI 3	100,000											
	S	N	H	M	E	L						
IEC 1	42,000	42,000	42,000	-	-	-						
IEC 2	-	50,000	50,000	65,000	65,000	-						
IEC 3	-	-	-	100,000	-	100,000						

Notes: Override has 7% pick up tolerance. Nominal setting is 98% of I_{cn} if no other instantaneous is on, or 107% of I_{cn} if any other instantaneous is on. UL 489 CB always have other instantaneous protection on. MCR set at 78% Close and Latch rating with a -10% tolerance. 6000A UL 489 CB is 100% rated as stationary and 80% rated draw-out.

ANSI Non-Automatic Switches				30 Cycle Withstand Ratings	Envelope 1		Envelope 2		Envelope 3	
Code	254V	580V	635V		Code	800-2000	800-3200	3200-5000		
N	42,000	42,000	42,000	1.	N	.				
M	65,000	65,000	65,000		M		.			
B	100,000	100,000	100,000		B				.	

UL489 Non-Automatic Switches				30 Cycle Withstand Ratings	Envelope 1		Envelope 2		Envelope 3	
Code	240V	480V	600V		Code	800-2000	800-3000	3000-6000		
N	42,000	42,000	42,000	1.	N	.				
M	65,000	65,000	65,000		M		.			
B	150,000	150,000	100,000		B				.	

¹Non-automatic switches are provided with no internal sensing or tripping mechanism and cannot be applied above their respective withstand levels. If non-automatic device is required at ratings above the available switches required, it is recommended that a circuit breaker set with maximum setting be employed using external control or protection as required by the application

² frame available as 3-pole only

Note: IEC Ratings are also available upon request.

UL489B Ratings Suitable for use in Photovoltaic system in accordance with article 690 of the NEC

Envelope	Type	Short Interrupting Current (kA)		Rated Endurance		
		800-3000	30	Minimum Mechanical Endurance	Minimum Electrical Endurance at 600Vdc	Minimum Electrical Endurance at 1000Vdc
2	M	800-3000	30	12500	500	500

Four configurations available for 600Vdc and 1000Vdc with or without isolating both DC legs.

Note: Bus Bars must be ordered separately

Time Constant (L/R) = 15msec, Rated calibration temperature 50°C.

Note: See EntelliGuard™ G Circuit Breaker Configurator for pricing. Contact a sales representative for configurator.

EntelliGuard™ G circuit breaker

EntelliGuard™ G circuit breaker nomenclature

Digit 6 Mounting

Designation	Mounting	Poles	Code
OEM	Drawout	3	1
		4, right	2
		4, left	3
	Stationary	3	4
		4, right	5
		4, left	6
ABB Equipment	Drawout	3	D
	Stationary	3	F

NOTE: Right, Left indicates the location of the fourth pole, typically used to switch the Neutral.

NOTE: 800A Envelope 2 (E, M Ratings) are not available in 4-pole design.

NOTE: P frame available as 3-pole only

Digit 7 Spring Charge Motor

Spring Charge Motor Electrically Operated (EO)		Code
DC	24/30Vdc	A
	48Vdc	B
	60Vdc	C
	72Vdc	D
	110/130Vdc	E
AC	250Vdc	F
	48Vac	G
	120Vac	H
	240Vac	J
	277Vac	K
Blank/None ¹	-	X

¹An "X" (Blank/None) denotes a Manually Operated device (MO) Spring Charge Contact, GSCC1, included with all Motor Operators.

NOTE: When a Spring Charging Motor is selected, a Closing Device must be selected from Closing Devices for Digit 8, and a Shunt Trip Device must be selected from Shunt Trip 1 Devices for Digit 9.

Shunt Trip 1 with a coil voltage different from the Spring Charge Motor may be user selected.

When a Motor & Spring Charge Contact is selected, the Ready To Close (RTC) (Digit 13) contact output options to the SD (Codes 1, 2, D, E, G, H, K, L) will be wired to the Spring Charge Contact location on the Secondary Disconnect Block.

Digit 8 Closing Devices

Closing Coil Type	Code	
Closing Coil (CC) ²	24Vdc	A
	30Vdc	B
	48Vac/dc	C
	60-72Vdc	D
	110Vdc/130Vdc; 120Vac	E
	208Vac	F
	220Vdc; 240Vac	G
	250Vdc; 277Vac	H
Command Operated Closing Coil (CCC) ³	24Vdc	M
	30Vdc	N
	48Vac/dc	P
	60-72 Vdc	Q
	110Vdc/130Vdc; 120Vac	R
	208Vac	S
220Vdc; 240Vac	T	
Blank/None	-	X

²The Closing Coil (CC) permits either local or remote release of the spring charged closing mechanism by electrical operation.

³The Command Operated Closing Coil (CCC) includes an additional anti-pumping safety feature to ensure that the electrical closing signal must be released before further closure is attempted, a shut off is initiated if the closing signal is maintained.

NOTE: Manual button through breaker cover is included as standard assembly.

NOTE: When a Spring Charging Motor is selected (Digit 7), a Closing Device must be selected from Closing Devices for Digit 8, and a Shunt Trip Device must be selected from Shunt Trip 1 Devices for Digit 9.

SELECT ONE DEVICE ONLY.

Digit 9 Shunt Trip

Extended Range Shunt Trip (ANSI/UL) ⁴	Code
24Vdc	M
48Vac/dc	P
70-72Vdc	Q
110/125Vdc; 120Vac	R
208Vac	S
220Vdc; 240Vac	T
250Vdc; 277Vac	V
Blank/none	X

⁴The Extended Range Shunt Trip is specifically intended and required for UL ANSI Ground Fault applications. The pick up range is 55-110% of the ST coil voltage.

When a motor is selected from the Spring Charging Motor (Digit 7) a Shunt Trip must be selected.

SELECT ONE DEVICE ONLY.

Digit 10 Under Voltage Release (UVR)

UVR with Fixed Time Delay ⁵	Code
24Vdc	1
30Vdc	2
48Vac/dc	3
60-72Vdc	4
110/130Vdc; 120Vac	5
208Vac	6
220Vdc; 240Vac	7
250Vdc; 277Vac	8
Blank/none	X

⁵The UVR Shunt Trip with Fixed Time Delay is specifically intended for applications where a delay period ('ride-through') is required due to potential voltage events. The design delays are 50msec when system voltage drops to 50% and 20 msec when system voltage drops below 50%.

An optional External UVR Time Delay Module is available in a 1 - 3sec delay.

SELECT ONE DEVICE ONLY.

EntelliGuard™ G circuit breaker

EntelliGuard™ G circuit breaker nomenclature

Digit 11 Second Shunt Trip, Second UVR

	Type	Code
Second UVR with Fixed Time Delay ¹	24Vdc	1
	30Vdc	2
	48Vac/dc	3
	60-72Vdc	4
	110Vdc/130Vdc; 120Vac	5
	208Vac	6
	220Vdc; 240Vac	7
	250Vdc; 277Vac	8
Second Extended Range Shunt Trip (ANSI/UL) ²	24Vdc	M
	48Vac/dc	P
	70-72Vdc	Q
	110/125Vdc; 120Vac	R
	208Vac	S
	220Vdc; 240Vac	T
Blank/none	250Vdc; 277Vac	V
	–	X

¹The UVR with Fixed Time Delay is specifically intended for applications where a delay period ('ride-through') is required due to potential voltage events. The design delays are 50msec when system voltage drops to 50% and 20msec when system voltage drops below 50%.

²The Extended Range Shunt Trip is specifically intended and required for UL ANSI Ground Fault applications. The pickup range is 55-110% of the ST coil voltage.

An optional External UVR Time Delay Module is available in a 1 - 3 second delay.

SELECT ONE DEVICE ONLY.

Digit 12 Auxiliary Switch, Coil Signaling Contact

Contact Configuration		Code
Auxiliary Switch, 3NO+3NC (Power Rated) ³ STANDARD/INCLUDED		2
Auxiliary Switch, 8NO+8NC (Power Rated) ⁴		4
Aux. Switch, 3NO/3NC (Power Rated) +2NO/2NC (High Fidelity)		6
Aux. Switch, 4NO/4NC (Power Rated) +4NO/4NC (High Fidelity) ⁴		8
Auxiliary Switch, 3NO+3NC (Power Rated)	CSC, PR, (1NO on SD) - Close Coil or CCC	A
	CSC, Hi-Fi via Trip Unit - Close Coil or CCC ⁵	B
	CSC, PR, (1NO on SD) - 1st Shunt Trip	C
	CSC, Hi-Fi via Trip Unit - 1st Shunt Trip ⁵	D
	CSC, PR, (1 NO on SD) - 1st UVR	E
	CSC, Hi-Fi via Trip Unit - 1st UVR ⁵	F
	CSC, PR, (1NO on SD) - 2nd ST or 2nd UVR	G
	CSC, Hi-Fi via Trip Unit - 2nd ST or 2nd UVR ⁵	H
Auxiliary Switch, 3NO/3NC (Power Rated)+2NO/2NC (High Fidelity)	CSC, PR, (1NO on SD) - Close Coil or CCC	J
	CSC, Hi-Fi via Trip Unit - Close Coil or CCC ⁵	K
	CSC, PR, (1NO on SD) - 1st Shunt Trip	L
	CSC, Hi-Fi via Trip Unit - 1st Shunt Trip ⁵	M
	CSC, PR, (1 NO on SD) - 1st UVR	N
	CSC, Hi-Fi via Trip Unit - 1st UVR ⁵	P
	CSC, PR, (1NO on SD) - 2nd ST or 2nd UVR	Q
	CSC, Hi-Fi via Trip Unit - 2nd ST or 2nd UVR ⁵	R
Auxiliary Switch, 3NO+3NC (Power Rated)	CSC, PR, (1NO on SD) - All Installed Devices	S
	CSC, Hi-Fi via Trip Unit - All Installed Devices ⁵	T
Aux. Switch, 3NO/3NC (Power Rated) + 2NO/2N (High Fidelity)	CSC, PR, (1NO on SD) - All Installed Devices	U
	CSC, Hi-Fi via Trip Unit - All Installed Devices ⁵	V

Abbreviations

CCC = Command Operated Close Coil

CSC = Coil Signaling Contact

Hi-Fi = High Fidelity

PR = Power Rated

SD = Secondary Disconnect

NOTE: The term "Hi Fidelity" (HiFi) refers to gold-plated contacts used for signal level outputs (10mA minimum - 100mA maximum, 5-30Vdc, 125Vac)

NOTE: If no devices were selected in Digit 8, 9, 10, 11 (Codes = "X"), then Options A - V are Invalid

NOTE: Options A-V are only valid if the corresponding device to be monitored by the Coil Signaling Contact (CSC) is selected in digits 8, 9, 10, 11

³The 3NO/3NC scheme is STANDARD (INCLUDED, CODE 2) and is wired to Secondary Disconnect Block A; all other selections require Secondary Disconnect Block B

⁴For Side-mounted Secondary Disconnect Blocks All options are available EXCEPT options (4 and 8)

⁵In order to output the Coil Signaling status HiFi via trip unit (Options B, D, F, H, K, M, P, R, T, and V) a communications package must be selected in Advanced Features (Digit 19; options "2, 3, 6, 7, 8, 9") This options requires Secondary Disconnect Block B.

If a UL or ANSI Switch is selected in Digit 2 (C, D, M, S), the HiFi via Trip unit Options are not valid (Options B, D, F, H, K, M, P, R, T, and V)

Note: See EntelliGuard™ G Circuit Breaker Configurator for pricing. Contact a sales representative for configurator.

EntelliGuard™ G circuit breaker

EntelliGuard™ G circuit breaker nomenclature

Digit 13 Bell Alarm, Mechanical Counter and Trip Annunciation

Bell Alarm, Mechanical Counter and Trip Annunciation	Code
Bell Alarm Contact (1NO/1NC) with Lockout (BACL)	A
Mechanical Operations Counter (MOC)	B
Bell Alarm Contact (1NO/1NC) with Lockout and MOC	C
RTC Power Rated Contacts on SD ¹	1
RTC Signal Rated (Hi-Fi) Contacts on SD ¹	2
RTC Signal Rated(Hi-Fi) Contacts through Trip Unit ²	3
RTC Signal Rated (Hi-fi) Conatctcs through Trip Unit	D
BACL and RTC Power Rated Contacts on SD ¹	E
BACL and RTC Signal Rated (Hi-Fi) Contacts on SD ¹	F
BACL and RTC Signal Rated (Hi-Fi) through Trip Unit ²	G
BACL,MOC and RTC Power Rated on SD ¹	H
BACL,MOC and RTC Signal Rated (Hi-Fi) through Trip Unit ²	J
MOC and RTC Power Rated on SD ¹	K
MOC and RTS Signal Rated on SD ¹	L
MOC and RTC Signal Rated (Hi-Fi) through Trip Unit ²	M
Blank/none	X

Abbreviations

BACL = Bell Alarm Contact with Lockout

RTC = Ready To Close Contacts

Hi-Fi = High Fidelity

SD = Secondary Disconnect

¹Ready To Close Switches are wired to where a Spring Charge Contact would be

²In order to output the RTC contact output via Trip Unit (options 3, F, J, M) a communications package must be selected in Advanced Features (Code 19/Step 16); this requires Secondary Disconnect Block B.

If a UL or ANSI Switch is selected, the (Hi-Fi Through Trip Unit) is not valid (Options 3, F, J, M).

RTC Through the Trip Unit is not a valid option for Switches. Bell Alarm Contact with Lockout comes with the Trip Unit set to Manual LO Enabled.

NOTE: The term "Hi-Fi" refers to gold-plated contacts used for signal level outputs (10mA minimum - 100mA maximum, 5-30Vdc, 125Vac).

Bell Alarm Contact with Lockout comes with the Trip unit set to Manual LO Enabled

Digit 14 Key Interlock and Padlock Provisions

Key Interlock (Breaker Mounted)	Code
Castell Key Interlock	C
Kirk Key Interlock	K
Ronis Key Interlock	R
Pushbutton Padlock Device	L
Castell Key Interlock and Push Button Padlock Device	1
Kirk Key Interlock and Push Button Padlock Device	2
Ronis Key Interlock and Push Button Padlock Device	3
Black/none	X

NOTE: This option provides factory installed interlocking devices for installation between separate circuit breakers (baseplates and mechanism). This safeguard ensures that a circuit breaker cannot be closed unless the dedicated key has been inserted and secured within the lock.

NOTE: If selecting a Draw Out Breaker (Digit 6), consider putting the Key Interlock on the Cassette versus the breaker. This enables the ability to swap breakers without having to change the key interlocks.

Locks and Keys are NOT Supplied by ABB.

Digit 15 Mechanical Interlocks

Mechanical Interlocks	Code
Black/None DEFAULT	X
Mechanical Interlock- Type A	1
Mechanical Interlock- Type B	2
Mechanical Interlock- Type C	3
Mechanical Interlock- Type D	4

Some installations use multiple power sources that are required to supply energy simultaneously, alternately, or, in a specified sequence. EntelliGuard™ G Circuit Breakers can be used to interconnect these sources and be electrically and mechanically interlocked to provide the necessary transition and protection. Mechanical Interlocks are available for fixed and draw out circuit breakers. The interlocks enable directly interlocking breakers that are mounted side by side or in vertical stacks. The interlocks consist of two components: (1) The factory installed bracket fitted to the breaker (fixed breakers) or the cassette (drawout breakers), and (2) The field-installable interconnecting cables available in lengths of 1.0, 1.6, 2.0, 2.5, 3.0, 3.5 and 4.0m (ordered separately). Refer to Section 4 of the Application Guide DET-653B for interlocking schemes.

Contact factory for availability.

EntelliGuard™ G circuit breaker

EntelliGuard™ G circuit breaker nomenclature

Digit 16 and 17 Over Current Protection Package

Type	Over Current (OC) Protection	Ground Fault	Code	
EntelliGuard™ G ANSI/UL OC Protection	Standard Range Instantaneous	LSI (S, switchable) (I, switchable ANSI only)	L3	
		LSIG (S, switchable) (I, switchable ANSI only)	L4	
		LSIGA (S, switchable) (I, switchable ANSI only) (G, Alarm Only)	L5	
		LSIC (S, switchable) (I, switchable ANSI only)	L6	
		LSICA (S, switchable) (I, switchable ANSI only) (C, Alarm Only)	L7	
		LSIGDA ¹ (S, G, A switchable) (I, switchable ANSI only)	L8	
		LSIGCDA ¹ (S, G, C, A all switchable) (I, switchable ANSI only)	L9	
		Extended Range Adjustable Instantaneous	LSH (S, switchable) (I, switchable ANSI only)	LC
			LSHG (S, switchable) (I, switchable ANSI only)	LD
	LSHGA (S, switchable) (I, switchable ANSI only) (G, Alarm Only)		LE	
	LSHC (S, switchable) (I, switchable ANSI only)		LF	
	LSHCA (S, switchable) (I, switchable ANSI only) (C, Alarm Only)		LG	
	LSHGDA ¹ (S, G, A switchable) (I, switchable ANSI only)		LH	
	LSHGCDA ¹ (S, G, C, A all switchable) (I, switchable ANSI only)		LK	
	NONE - (For Switch Only)		-	XX

¹Function Combination is NOT UL Listed

NOTES:

- L = Long Time (L, I²T) + Fuse Settings (I⁴T) (Fuse settings are now standard on all EntelliGuard™ Trip Units)
- S = Short Time (Switchable if Instantaneous (I) protection is enabled)
- I = Standard Range Adjustable Instantaneous, (IOC, 2x-15x)
- H = Extended Range Adjustable Instantaneous, (IOC, 2x-30x), Not available in UL489 version of Entelliguard G or any Legacy CB
- G = Ground Fault Protection (GFP, 3-wire or 4-wire, internal summing)
- C = External CT for ground fault detection (AKD20 application: input from external summing CTs, used for multiple source ground fault detection.
OEM Application: Zero Sequence Input of (IA = 100%)
- D = Defeatable/Switchable Ground Fault NOT UL Listed
- A = Ground Fault, External Ground Fault, Alarm only
- GA = Ground Fault Alarm Only
- CA = External Ground Fault Alarm Only
- GDA, GCDA = Ground Fault Trip and Ground Fault Alarm (all switchable, Not UL Listed)
- Option "XX" is the only valid option when a Switch is selected in Digit 2

Digit 18 Zone Selective Interlocking (ZSI)

Zone Selective Interlocking	Code
ZSI, Short time and GF; user selectable	Z
Z+IOC or HSIOC ZSI; user selectable	T
Blank/none	X

ZSI selections require Secondary Disconnect Block B and 24Vdc control power.

NOTE: Option X is the only valid item when a Switch is selected in Digit 2.

Digit 19 Advanced Features and Communications

Advanced Features and Communications	Code
Reduced Energy Let Through (RELT)	1
Modbus Protocol + RELT	2
Profibus Protocol + RELT	3
Monitoring + RELT, NO communication	4
Monitoring + Relay Package + RELT	5
Monitoring+ Data Acquisition, Modbus Protocol + RELT	6
Monitoring+ Data Acquisition, Profibus Protocol + RELT	7
Monitoring + Data Acquisition, Relay Package, Profibus, RELT	8
Monitoring + Data Acquisition, Relay Package, Modbus RELT	9
None	X

NOTES:

- All Advanced Feature selections require Secondary Disconnect Block B and 24Vdc control Power.
- Option "X" is the only valid option when a Switch is selected in Digit 2.
- RELT = Reduced Energy Let Through, requires dedicated input and output on the CB Monitoring = Advanced Metering.
- Data Acquisition = Waveform Capture and Harmonic Analysis.
- In order to output the Coil Signaling status HiFi via trip unit (Digit 12, Options B, D, F, H, K, M, P, R, T, and V) a communications package must be selected in Advanced Features (Digit 19; options 2, 3, 6, 7, 8, 9). This option requires Secondary Disconnect Block B.
- In order to output the RTC contact output via Trip Unit (Digit 13; Options 3, F, J, M) a communications package must be selected in Advanced Features (Code 19/Step 16); this requires Secondary Disconnect Block B.

Digit 20 Rating Plug

Rating Plug	Product Number	Code
150	GTP0150U0104	B
200	GTP0200U0204	C
225	GTP0225U0306	D
250	GTP0250U0407	E
300	GTP0300U0408	F
350	GTP0350U0408	G
400	GTP0400U0410	H
450	GTP0450U0612	I
500	GTP0500U0613	J
600	GTP0600U0616	K
700	GTP0700U0816	M
750	GTP0750U0820	N
800	GTP0800U0820	O
900	GTP0900U1020	P
1000	GTP1000U1025	Q
1100	GTP1100U1225	R
1200	GTP1200U1232	S
1500	GTP1500U1640	U
1600	GTP1600U1640	V
1900	GTP1900U2050	W
2000	GTP2000U2050	Y
2200	GTP2200U2550	Z
2400	GTP2400U2564	1
2500	GTP2500U2564	2
3000	GTP3000U3064	3
3200	GTP3200U3264	4
3600	GTP3600U4064	5
4000	GTP4000U4064	6
5000	GTP5000U5064	7
6000	GTP6000U6064	8
Rating plug not required/non auto switch		X

NOTE: See Section 6 for further details on rating plugs and sensors. Option X is the only valid option when a Switch is selected in Digit 2.

Note: See EntelliGuard™ G Circuit Breaker Configurator for pricing. Contact a sales representative for configurator.

EntelliGuard™ G low voltage power circuit breakers

EntelliGuard™ G cassettes nomenclature

The drawout mechanism allows the breaker to be racked in four distinct positions (CONNECTED, TEST, DISCONNECTED, WITHDRAWN).

(CONNECTED, TEST, DISCONNECTED, WITHDRAWN).

Choice of whether shutters are needed are based in the order option 2nd disconnect Block B (GSDWCR).

EntelliGuard™ G Cassette Product Number Structure

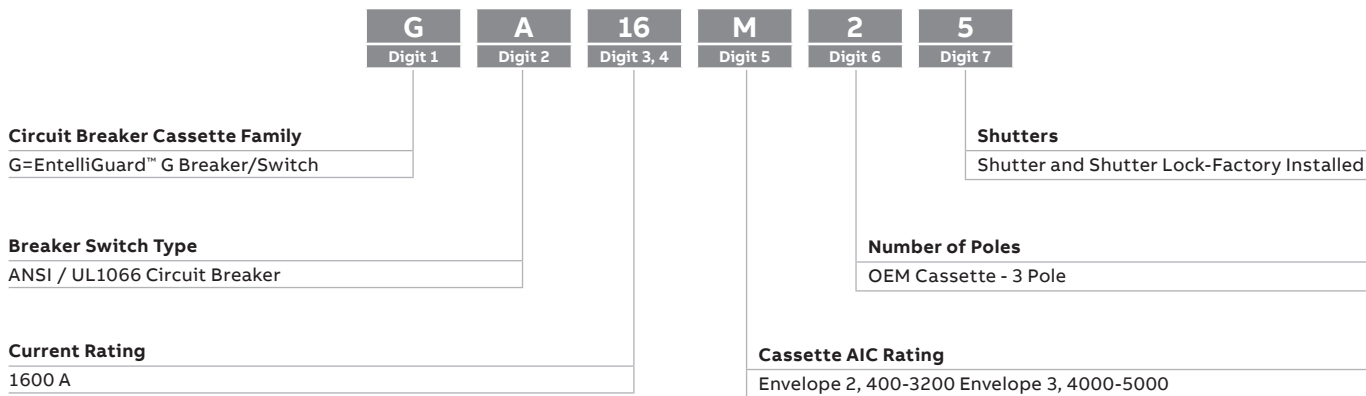

Digit 1 Circuit Breaker Cassette Family

Devices Series/Line	Code
EntelliGuard™ G Breaker/Switch	G

Digit 2 Breaker Switch Type

Breaker/Switch Type, Secondary Mounting	Envelope 1		Envelope 2 & 3
	Side	Top	Top
ANSI/UL1066 Circuit Breaker	A	N	A
UL 489 Circuit Breaker	B	U	B
ANSI Non-auto CB (ANSI Switch)	C	M	C
UL489 Non-auto CB (UL Switch)	D	S	D

Top = Top Mounted Secondary Disconnects (TSD).

Side = Side Mounted Secondary Disconnects (SSD). (Available on Envelope 1 only.)

NOTE: N, U, M, S characters are for Envelope 1 only with top mounted secondary disconnects (TSD).

When ordering codes A, B, C, D, Side Secondary Disconnects (SSD) are supplied as standard on Envelope 1.

Codes N, U, M, S are not valid for Envelopes 2 and 3.

Envelope 1 (Type N and H, 400A - 2000A).

NOTE: DC Ratings; trip unit not included. DC Rated Circuit Breakers require external control devices (e.g., Type 37 or Type 76 DC Relays).

NOTE: Side Secondary Disconnects are specifically intended for 5-High ("high density") equipment designs.

With Side Mounted Disconnects (SSD), the following Aux. Switches are not valid (In Digit 12); Auxiliary Switch, 8NO+8NC (Power Rated) or Aux. Switch, 4NO/4NC (Power Rated) + 4NO/4NC (High Fidelity).

Digit 3 and 4 Current Rating

Current Rating (A)	Circuit Breaker	
	ANSI	UL489
800	08	08
1600	16	16
2000	20	20
3000	-	30
3200	32	-
5000	50	-
6000	-	60

NOTE: Select Current Rating equal to or the next higher of the Circuit Breaker or Switch Current Rating

EntelliGuard™ G low voltage power circuit breakers

EntelliGuard™ G cassettes nomenclature

Digit 5 Cassette AIC Rating

Interrupting Rating Tier ANSI/UL1066 Devices, LVPCB								Envelope 1		Envelope 2		Envelope 3		
Code	254V	580V	635V	1/2S Withstand	HSIOC	Override No. 1	Override WI	Code	400-1200	400-2000	3200	400-3200	3200	4000-5000
S	65,000	65,000	50,000	50,000	50,000	49,000	53,500	S	.					
N	65,000	65,000	65,000	65,000	None	None	None	N		.	.			
H	85,000	85,000	65,000	65,000	65,000	63,700	69,500	H		.				
P ²	100,000	100,000	65,000	65,000	65,000	63,700	69,500	P		.				
E	85,000	85,000	85,000	85,000	None	None	None	E				.		
M	100,000	100,000	100,000	85,000	85,000	83,800	90,950	M				.		.
B	100,000	100,000	100,000	100,000	None	None	None	B					.	.
L	150,000	150,000	100,000	100,000	100,000	98,000	107,000	L					.	.

Interrupting Rating Tier UL489 Devices ICCB								Envelope 1		Envelope 2		Envelope 3		
Code	240V	480V	600V	1/2S Withstand	HSIOC	Override No. 1	Override WI	Code	400-1200	400-2000	2500-3000	400-3000	3000	4000-6000
S	65,000	65,000	50,000	42,000	42,000	N/A	44,940	S	.					
N	65,000	65,000	65,000	42,000	42,000	N/A	44,940	N		.	.			
H	85,000	85,000	65,000	50,000	50,000	N/A	53,500	H		.	.			
M	100,000	100,000	100,000	65,000	65,000	N/A	69,550	M				.		.
L	150,000	150,000	100,000	85,000	85,000	N/A	90,950	L					.	.
P ²	100,000	100,000	65,000	50,000	50,000	N/A	50,000	P		.				

ANSI Non-Automatic Switches				30 Cycle Withstand Ratings				Envelope 1		Envelope 2		Envelope 3			
Code	254V	580V	635V	Code	800-2000	800-3200	3200-5000	Code	800-2000	800-3000	3000-6000	Code	800-2000	800-3000	3000-6000
N	42,000	42,000	42,000	Note: Non-automatic switches are provided with no internal sensing or tripping mechanism and cannot be applied above their respective withstand levels. If a non-automatic device is required at ratings above the available switches is required, it is recommended that a circuit breaker set with maximum setting be employed using external control or protection as required by the application.	N	.		N	.			N	.		
M	65,000	65,000	65,000		M		.	M		.		M		.	
B	100,000	100,000	100,000		B			.	B			.	B		
UL489 Non-Automatic Switches					Envelope 1		Envelope 2		Envelope 3						
Code	240V	480V	600V	Code	800-2000	800-3000	3000-6000	Code	800-2000	800-3000	3000-6000				
N	42,000	42,000	42,000	N	.			N	.						
M	65,000	65,000	65,000	M		.		M		.					
B	150,000	150,000	100,000	B			.	B			.				

Digit 6 Number of Poles

Devices Series/ Line	Code
OEM Cassette - 3 Pole	2
OEM Cassette - 4 Pole	5
ABB Equipment Cassette - 3 Pole ¹	7

¹ABB Equipment cassette designed specifically for AKD20 Switchgear. These cassettes are NOT available for OEMs.

²P frame available as 3-pole only

Digit 7 Shutters

Shutters with Locks	Code
Shutter and Shutter Lock - Factory Installed	S
None	X

Loose Cassette Parts- Field Installed	Product Number
Carriage Position Switch - 1NO/1NC	GCPS1R
Carriage Position Switch-2NO/2NC	GCPS2R
1 Kirk Key Interlock Cam for Cassette	GCKRKR
1 Ronis Key Interlock Cam for Cassette	GCR0NR
Secondary Disconnect Block B, 39 Pole-Top Mounted	GSDWTR
Secondary Disconnect Block B, 39 Pole-Side Mounted	GSDWSR

Secondary Disconnect Block B is required when:

- Any "ZONE SELECTIVE INTERLOCKING" options are selected in breaker/trip unit Catalog Digit 18.
- Any "ADVANCED FEATURES" are selected in breaker/trip unit Catalog Digit 19.
- A COIL SIGNALING CONTACT OPTION is selected, Digit 12.
- A READY TO CLOSE signal via the trip unit is selected, Digit 13.
- Any of the following OPTIONAL Aux. Contact Switches are selected in Digit 12:
 - 8NO/NC POWER RATED
 - 3NO/NC POWER RATED + 2NO/NC Hi-Fi
 - 4NO/NC POWER RATED + 4NO/NC Hi-Fi

EntelliGuard™ G low voltage power circuit breakers

EntelliGuard™ G accessories

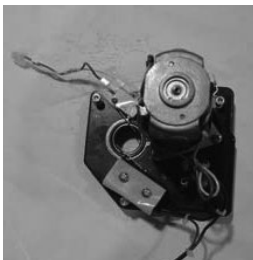

A wide range of optional accessories are interchangeable across all EntelliGuard G power circuit breakers, regardless of nominal rating or envelope/frame size.

Motorized Spring Charging Unit

The unique motor/gearbox unit is specially designed to operate with the full range of EntelliGuard G breakers. It is easily installed with three heavy-duty bolts. After a breaker close operation, the unit automatically recharges the spring and makes it ready for immediate re-close should the need arise. High speed recharging ensures that the springs are fully charged within approximately three seconds following a release. All electrically operated (EO) ANSI/UL breakers are equipped with “Spring Charged” contacts for status indication.



Motorized Spring Charging Unit

Motorized Spring Charging Unit

Envelope	Power Consumption	Nominal Control Voltage	UL and IEC Range (85% to 110%)	ANSI Range	Product Number
1	DC - 300W	24Vdc/30Vdc	20.4V to 26.4V	–	GM01024DR
		48Vdc	40.8V to 52.87V	38V to 56V	GM01048DR
		60Vdc	51V to 66V	–	GM01060DR
		72Vdc	61.2V to 79.2V	–	GM01072DR
		110Vdc/130Vdc	106.25V to 137.5V	100V to 140V	GM01110DR
1	AC - 350VA	250Vdc	212.5V to 275V	200V to 280V	GM01250DR
		48Vac	40.8V to 52.87V	–	GM01048AR
		120Vac	102V to 132V	104V to 127V	GM01120AR
		240Vac	204V to 264V	208V to 254V	GM01240AR
2 and 3	DC - 480W	277Vac	235.5V to 304.7V	–	GM01277AR
		24Vdc/30Vdc	20.4V to 26.4V	–	GM02024DR
		48Vdc	40.8V to 52.87V	38V to 56V	GM02048DR
		60Vdc	51V to 66V	–	GM02060DR
		72Vdc	61.2V to 79.2V	–	GM02060DR
2 and 3	AC - 560VA	110Vdc/130Vdc	106.25V to 137.5V	100V to 140V	GM02110DR
		250Vdc	212.5V to 275V	200V to 280V	GM02250DR
		48Vac	40.8V to 52.87V	–	GM02048AR
		120Vac	102V to 132V	104V to 127V	GM02120AR
		240Vac	204V to 264V	208V to 254V	GM02240AR
		277Vac	235.5V to 304.7V	–	GM02277AR

EntelliGuard™ G low voltage power circuit breakers

EntelliGuard™ G accessories



Close Coil

Circuit Breaker Closing Coils Standard and Command

Two, easy-to-fit, clip-on closing coil options with simple, plug-in connections are available. Both options offer electrical remote release of the spring charged closing mechanism. Both options include a standard anti-pump safety feature ensuring that the close signal must be released before further close commands are allowed. The Command Close Coil additionally provides for local breaker close and remote breaker close over communications via the EntelliGuard Trip Unit.

Command Operation Module

This module energizes the closing coil to cause the breaker to close whenever control power is applied to the accessory and when commanded from the breaker trip unit or breaker front panel push button (electrical closing.)

Closing Coil / Command Operation Module

Type	Power Consumption	Nominal Control Voltage	Product Number
Closing Coil (CC)	DC: 350W, 20 W (sealed) AC: 350W (inrush), 20W (sealed)	24Vdc	GCCN024DR
		48Vac/dc	GCCN048R
		60 to 72Vdc	GCCN060DR
		110/130/120Vac	GCCN120R
		208Vac	GCCN208AR
		220Vdc/240Vac	GCCN240R
Command Closing Coil (CCC)	DC: 350W, 20W (sealed) AC: 350W (inrush), 20W (sealed)	250Vdc/277Vac	GCCN277R
		24Vdc	GCCC024DR
		48Vac/dc	GCCC048R
		60 to 72Vdc	GCCC060DR
		110/130/120Vac	GCCC120R
		208Vac	GCCC208AR



Shunt Trip

Shunt Trip for Ground Fault

Energizing the shunt trip (ST), via local or remote input, will instantaneously activate the circuit breaker mechanism, ensuring a rapid open operation. The shunt trip is continuously rated and does not require an auxiliary switch in series with the coil. The shunt trip is a straightforward, field installable accessory available in wide range of voltages.

Nominal Control Voltage	Product Number
24Vdc	GSTG024DR
48Vac/dc	GSTG048R
70/72Vac	GSTG072DR
125Vdc	GSTG125DR
110Vdc/120Vac	GSTG120R
208Vac	GSTG208AR
240Vac	GSTG240R
250Vdc/277Vac	GSTG250DR

EntelliGuard™ G low voltage power circuit breakers

EntelliGuard™ G accessories



Status Indication Switch

Status Indication Switch (Coil Signaling Contact)

A plug-in module is available to provide status indication via the secondary disconnects and trip unit. Coil Signaling Contacts are available for closing coils, shunt trips and under voltage releases. Contact is mounted on top of the Accessory Device. One of the low signal (Hi-Fi) contacts is always wired to the trip unit.



Status Indication Switch

Type and Configuration	Rating	Voltage	Amps	Product Number
1 Power rated + 1 Low signal (Hi-Fi) (1NO contact each)	AC	120Vac	6	GCSP1R
	AC	250Vac	6	
	DC	120Vac	0.5	
	DC	250Vac	0.25	
	AC	125Vac	0.1	
2 Low signal (Hi-Fi) (1NO contact each)	AC	125Vac	0.1	GCSP2R



Under Voltage Release

Under Voltage Release (UVR) with Fixed Time Delay

The UVR instantaneously activates the circuit breaker trip mechanism when the source voltage drops below the low voltage threshold. The UVR is also a simple, field installable device.

Power Consumption	Nominal Control Voltage	Product Number
DC: 350W, 2W (sealed)	24Vdc	GUVT024DR
	30Vdc	GUVT030DR
	40Vdc; 48Vac/dc	GUVT048R
	60 - 72Vdc	GUVT060DR
	110Vdc/130Vdc; 120Vac	GUVT120R
AC: 350W (inrush), 20W (sealed)	208Vac	GUVT208AR
	220Vdc; 240Vac	GUVT240R
	250Vdc; 277Vac	GUVT277R

Duty Cycle = 2/min.
Inrush = 350VA (AC), 350W (DC)
Holding = 60VA (AC), 50W (DC)

EntelliGuard™ G low voltage power circuit breakers

EntelliGuard™ G accessories



Time Delay Module

Time Delay Module (TDM) for UVR (Externally Mounted)

The de-energized operation of the Undervoltage release can be delayed. This optional, externally mounted module has an adjustable time delay of 0 seconds to 3 seconds. The device can be implemented to prevent undesired breaker tripping due to momentary voltage interruptions and is connected in series with the Undervoltage release. The time delay is in addition to the time delay from the breaker mounted UVR accessory. The time delay module starts counting at 50% of rated voltage.

Nominal Control Voltage	Product Number
48Vdc	GTDM048D
48Vac	GTDM048A
60Vdc	GTDM060D
125Vdc	GTDM120D
120Vac	GTDM120A
208Vac	GTDM208A
240Vdc	GTDM240D
240Vac	GTDM240A
250Vdc	GTDM250D
277Vac	GTDM277A



Ready To Close Contact

Ready To Close Contact

These contacts indicate that the following conditions are met and the circuit breaker can be closed:

- The circuit breaker is open.
- The closing springs are charged.
- The circuit breaker is not locked/interlocked in open position.
- There is no standing closing signal.
- There is no standing opening signal.

1 NO

	Voltage	Amps	Description	Product Number
AC	120Vac	6	High fidelity/secondary disconnect	GRTC2R
	250Vac	6	-	
DC	125Vdc	0.5	Power rated/secondary disconnect	GRTC1R
	250Vdc	0.25	High fidelity/trip unit	GRTC3R



Auxiliary Switches

Auxiliary Switches

Auxiliary switches indicate breaker main contact position. They change their state in the same time sequence as the breaker main contacts.

Contact Configuration	Power Rated	Hi-Fi	Product Number
Power rated (3NO, 3NC)	A14 - A25	N/A	GAUX3R
Power rated (3NO, 3NC); low signal (Hi-Fi), (2NO, 2NC)	A14 - A25	B10 - B13, B23 - B26	GAUX5R
Power rated (8NO, 8NC)	A14 - A25, B4 - B13, B17 - B26	N/A	GAUX6R
Power rated (4NO, 4NC); low signal (Hi-Fi), (4NO, 4NC)	A14 - A25, B12 - B13, B25 - B26	B4 - B11, B17 - B24	GAUX8R

EntelliGuard™ G low voltage power circuit breakers

EntelliGuard™ G accessories

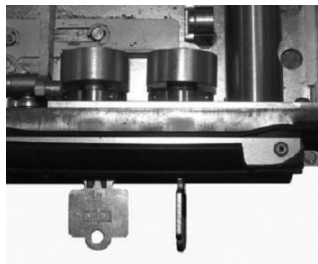

Key Interlock Facility

Circuit Breaker - Key Interlock Facility

This option supplies factory-installed key interlock mounting provisions (baseplates and mechanism) on the front of the breaker fascia. Key interlocks ensure that a circuit breaker cannot be closed unless the dedicated key has been inserted and secured within the lock. Circuit breakers accept ready-to-fit interlocking device kits such as Castell, Ronis, Kirk and Profalux for installation between related, separate circuit breakers.

Description	Product Number
Baseplate and mechanism for Kirk Key Locks (Breaker Mounted)	GBKRKR
Baseplate and mechanism for Ronis Locks (Breaker Mounted)	GBRONR
Mechanism for Ronis Key cassette interlock (Cassette mounted)	GCRONR
Mechanism for Kirk Key cassette interlock (Cassette mounted)	GCKRKR



Carriage Position Switch (TOC)

Carriage Position Switch (TOC)

Available as an option for mounting within the base of the cassette/substructure, the carriage position switch provides six single-pole changeover contacts (single pole, double throw) for local or remote electrical indication of the circuit breaker status: CONNECTED, TEST and DISCONNECTED. The DISCONNECTED position is indicated only when minimum isolating distances between contacts on both the main and auxiliary circuits have been achieved. This option is in addition to the mechanical indicators, which are fitted as standard. When installed, the carriage switch is IP2X protected.

Switch Configuration	Product Number
1 NO/NC switch per position	GCPS1R
Set of 2 NO/NC switches per position	GCPS2R
Set of 6 NO/NC switches connected position	GCPS3R

EntelliGuard™ G low voltage power circuit breakers

EntelliGuard™ G accessories

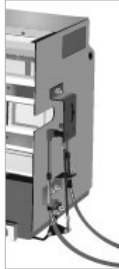

Mechanical Interlocks (Cable/Rod) (OEM Applications Only)

Available for fixed and draw-out circuit breakers, these units enable the direct interlocking of EntelliGuard G circuit breakers, either mounted side-by-side or stacked. The interlocking mechanisms are connected by a specially designed cable or rod in a 1 from 2, 1 from 3, and 2 from 3 configuration, and any mix of current ratings/pole configurations can be accommodated.

Interlock Type	Number of Cables Required	Breaker Type	Poles	Product Number
2 Way - Type A	2	Withdrawable	3	GI2WADR
		Withdrawable	4	GI3WADR
		Fixed	3	GI2FADR
		Fixed	4	GI3FADR
1 from 2 - Type B	6	Withdrawable	3	GI2WBR
		Withdrawable	4	GI3WBR
		Fixed	3	GI2FBR
		Fixed	4	GI3FBR
2 from 3 - Type C	6	Withdrawable	3	GI2WCR
		Withdrawable	4	GI3WCR
		Fixed	3	GI2FCR
		Fixed	4	GI3FCR
1 from 3 - Type D	4	Withdrawable	3	GI2WDTR
		Withdrawable	4	GI3WDTR
		Fixed	3	GI2FDTR

Refer to Section 4 of the Application Guide DET-653B for interlocking schemes.

Mechanical Interlock Cables

Standard cable lengths are shown. (Cables ordered separately. Please contact our technical customer service department if longer length is required.)

Length (M/In)	Product Number
1 / 39.4	GCB1
1.6 / 63	GCB2
2 / 78.7	GCB3
2.5 / 98.4	GCB4
3 / 118/1	GCB5
3.5 / 137.8	GCB6
4 / 157.5	GCB7



Bell Alarm with Lockout

Bell Alarm with Lockout

The Bell Alarm provides remote indication that the circuit breaker has opened because of an electrical fault. The Lockout feature is integral to the trip unit. When a Bell Alarm is supplied with the breaker, the Trip Unit dial is set and locked to the manual position. In order to re-close the breaker, the Lockout button must be pushed in/reset on the Trip Unit 1-Form C contact.

Switch Configuration	Product Number
Single pole, double throw (1-Form C contact)	GBAT1R

EntelliGuard™ G low voltage power circuit breakers

EntelliGuard™ G accessories



Charging Spring Status Indicator

Charging Spring Status Indicator

Factory-installed on the motor, this auxiliary switch indicates that the circuit breaker is charged and is standard with the spring-charging motor.

Ratings		Product Number
Voltage	Amps	
120Vac	6	GSCC1R
250Vac	6	
125Vdc	0.5	
250Vdc	0,25	

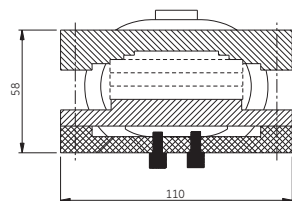
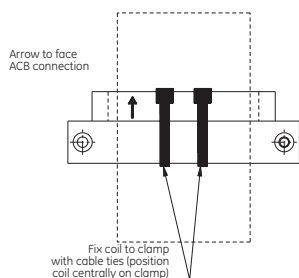

Remark: for ratings > 4000A two coils are used

Neutral Rogowski External

Neutral Rogowski

The Neutral Rogowski CT's are used to measure the Neutral Current and is required when Internal Ground Fault is selected on the trip unit. There are two types available: Encased with Terminal Screws: The Rogowski coil is encased with two terminal screws. No additional mounting hardware is required as the encasing is molded to the mounting dimensions.

Loose Rogowski Coil with separate mounting hardware: The coil and mounting hardware are separate. The coil comes with the two wire leads for connection to a terminal block.

Type	Envelope	Current Rating (A)	Product Number	
Encased with Terminal Screws	1	400	G04HNRCE	
		600/630	G07HNRCE	
		800	G08HNRCE	
		1000	G10HNRCE	
		1200/1250	G13HNRCE	
		1600	G16HNRCE	
		2000	G20HNRCE	
	2	2	400	G04MNRCE
			600/630	G07MNRCE
			800	G08MNRCE
			1000	G10MNRCE
			1200/1250	G13MNRCE
			1600	G16MNRCE
			2000	G20MNRCE
			2500	G25MNRCE
			3000/3200	G32MNRCE
			3000/3200 (1600 x 2)	G32LNRCE
	3	3	4000 (2000 x 2)	G40LNRCE
			5000 (2500 x 2)	G50LNRCE
			6000/6400 (3200 x 2)	G64LNRCE
			400	G04HNRC
Loose Rogowski Coil and Mounting Hardware	1	600/630	G07HNRC	
		800	G08HNRC	
		1000	G10HNRC	
		1200/1250	G13HNRC	
		1600	G16HNRC	
		2000	G20HNRC	
		2	2	400
	600/630			G07MNRC
	800			G08MNRC
	1000			G10MNRC
	1200/1250			G13MNRC
	1600			G16MNRC
	2000			G20MNRC
	2500			G25MNRC
	3000/3200			G32MNRC
	3000/3200 (1600 x 2)			G32LNRC
	3	3	4000 (2000 x 2)	G40LNRC
			5000 (2500 x 2)	G50LNRC
			6000/6400 (3200 x 2)	G64LNRC
			400	G04HNRC

EntelliGuard™ G low voltage power circuit breakers

EntelliGuard™ G accessories



IP54 Door Escutcheon

Door Escutcheon Kit for IP54 Protection

An optional complete IP54 front door panel is available when a higher degree of protection is needed.

Description	Product Number
Door Escutcheon Kit - IP54 Door Panel - Fixed/ Drawout	G54DR

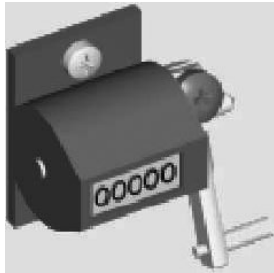

Mechanical Operations Counter

Mechanical Operations Counter

Used with either manual or motor charged circuit breakers, the counter provides an accurate record of the cumulative number of complete breaker closing operations.

Description	Product Number
Mechanical Operations Counter	GMCNR

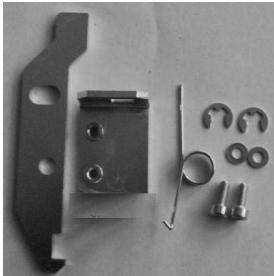

Door Interlock Kit

Door Interlock Kit

A door interlock mechanism may be fitted inside the cassette on the right for Left hinged door or Left for Right hinged door. Specify whether door is Left hand or Right hand hinged when ordering. Door interlock is different for a cassette with side mounted secondary disconnect.

Description	Product Number
Door Interlock (Left Side)	GLHD
Door Interlock (Right Side)	GRHD

Front Flat Terminations

The EntelliGuard G Fixed mounted breaker comes standard with Back Connected Terminations. Optional Front Flat terminations are available for front access mounting.

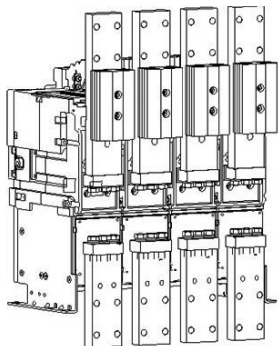

Front Flat Terminations

Description	Product Number
Env1 800 - 2000A, Type N&H, Flat Front UL489, Fixed 3 Pole Breaker Bus Bar Terminations (Top/Bottom)	GBB1TBF3
Env1 800 - 2000A, Type N&H, Flat Front UL489, Fixed 4 Pole Breaker Bus Bar Terminations (Top/Bottom)	GBB1TBF4
Env2 800A - 3000A Flat Front UL489 Fixed 3 Pole Breaker Bus Bar Terminations (Top/Bottom)	GBB2TBF3
Env2 800A - 3000A Flat Front UL489 Fixed 4 Pole Breaker Bus Bar Terminations (Top/Bottom)	GBB2TBF4
Env3 4000-6000A Flat Front UL Fixed 3 Pole Breaker Bus Bar Terminations (Top/Bottom)	GBB3TBF3
Env3 4000-6000A Flat Front UL Fixed 4 Pole Breaker Bus Bar Terminations (Top/Bottom)	GBB3TBF4

EntelliGuard™ G low voltage power circuit breakers

EntelliGuard™ G accessories

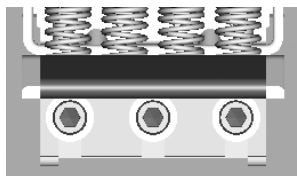

Arcing Contacts Assembly

Arcing Contacts Assembly

Arcing contacts are supplied with the EntelliGuard breaker.

Description	Product Number
Ent. Grd 1p EG1 H Type	G20HARC
Ent. Grd 1p EG1 S&N type	G20NARC
Ent. Grd 1p EG2 H&M type	G40MARC
Ent. Grd 1p EG2 E&N type	G40NARC
Ent. Grd 1p EG33200-6400A	G64LARC



Contact Wear Indicator

Contact Wear Indicator

The contact wear indicator is a simple device that allows the user to establish if the main contacts need replacement. It can be used on devices of the fixed pattern (if the arc chutes can be removed) and on devices of the draw out pattern.

Description	Product Number
Contact Wear Indicator	GCNTW

Racking Handle

A collapsible Racking Handle is provided to rack in/out the draw out breakers whenever needed.



Racking Handle

Description	Product Number
Racking Handle	GRHNR

Back Connected Terminations Fixed Envelope

Terminal assemblies are supplied with the EntelliGuard breaker. Fixed breakers have back or front connected terminations available.

Envelope Size	Description	Type	Product Number
1	Up to 1600A	3 Pole	GBB116TBB3
		4 Pole	GBB116TBB4
	200A	3 Pole	GBB120TBB3
		4 Pole	GBB120TBB4
2	Up to 2000A	3 Pole	GBB220TBB3
		4 Pole	GBB220TBB4
	3000A UL	3 Pole	GBB230TBB3
		4 Pole	GBB230TBB4
	3200A ANSI	3 Pole (Top Side)	GBB232TBB3
		3 Pole (Bottom Side)	GBB232BBB3
4 Pole (Top Side)		GBB232TBB4	
4 Pole (Bottom Side)		GBB232BBB3	
3	up to 4000A	3 Pole	GBB340TBB3
		4 Pole	GBB340TBB4
	6000A	3 Pole (Top Side)	GBB360TBB3
		3 Pole (Bottom Side)	GBB360BBB3
		4 Pole (Top Side)	GBB360TBB4
		4 Pole (Bottom Side)	GBB360BBB4

EntelliGuard™ G low voltage power circuit breakers

EntelliGuard™ G accessories

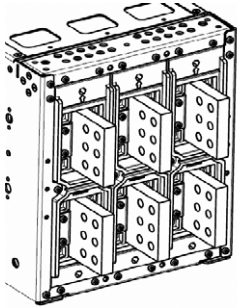

Envelope 1 and 2, 3 Pole 1600A

Back Connected Terminations For Cassette

Envelope Size	Description	Type	Product Number	
1	Up to 1600A	3 Pole	GBB216TBBC3	
		4 Pole	GBB216TBBC4	
	200A	3 Pole	GBB220TBBC3	
		4 Pole	GBB220TBBC4	
2	Up to 1600A	3 Pole	GBB216TBBC3	
		4 Pole	GBB216TBBC4	
	Up to 2000A	3 Pole	GBB220TBBC3	
		4 Pole	GBB220TBBC4	
	3000A UL	3 Pole	GBB230TBBC3	
		4 Pole	GBB230TBBC4	
	3200A ANSI	3 Pole (Top Side)	GBB232TBC3	
		3 Pole (Bottom Side)	GBB232BBC3	
		4 Pole (Top Side)	GBB232TBC4	
		4 Pole (Bottom Side)	GBB232BBC4	
	3	6000A	3 Pole (Top Side)	GBB360TBC3
			3 Pole (Bottom Side)	GBB360BBC3
4 Pole (Top Side)			GBB360TBC4	
6000A		4 Pole (Bottom Side)	GBB360BBC4	

Envelope 2, Cluster Pad
(Single Cluster) 2000A

Cluster Pad

Envelope Size	Description	Product Number
1	Cluster Pad (set per phase) Qty 2 per	GBB120TBD
2	Cluster Pad (single cluster) 2000A Qty 2 per	GBB220TBD
	Cluster Pad (double cluster) 2500A - 3200A Qty 2 per	GBB232TBD
3	Cluster Pad Qty 2 per	GBB360TBD

Cluster

Envelope Size	Description	Product Number
1	36 finger (95x20 mm) Qty 1	G20NCLS
2	36 finger (95x20 mm) Qty 1	G20MCLS
	36 finger (95x15 mm) Qty 1	G32ECLS
3	36 finger (95x15 mm) Qty 1	G64LCLS

Fixed Secondary Disconnect
(Breaker Mounted)

Fixed Secondary Disconnect (Breaker Mounted)

Fixed breakers are always supplied with a secondary disconnect (auxiliary connection block) suitable for 39 connection points (terminal A). When the number of factory installed accessories exceeds the available number of connection points needed, a 2nd connection block is automatically added (terminal B). For cases where the accessories are mounted in the field, an additional auxiliary connection block can be added to provide 39 more connections.

Description	Product Number
Fixed Breaker Top Mounted Secondary Disconnect, 39 Pole Male/Female	GSDFTR1
Fixed Breaker Top Mounted Secondary Disconnect, 78 Pole Male/Female	GSDFTR2
Fixed Breaker Side Mounted Secondary Disconnect, 78 Pole Male/Female	GSDFSR

EntelliGuard™ G low voltage power circuit breakers

EntelliGuard™ G accessories



Network Interlock Device (NI)

Network Interlock Device (NI)

The Network Interlock Device locks the breaker in the OFF position electrically and mechanically. When this device receives a pulse all local breaker functionality is disabled, except the tripping of the device on any over current fault. On the receipt of a 2nd pulse normal operation is re-instated. The presence of mains power does not affect the locking and/or re-instatement of this device. Each device has a local RESET button that only can be accessed after breaker cover removal.

Description	Product Number
Network Interlock 120V, UL Listed	GNTK120R



Remote Racker

Remote Racker

The Remote Racking Operator allows the user to move a draw out circuit breaker between the CONNECT and DISCONNECT positions via an electric racking gear head motor and the cassette housing the breaker. The remote racking operator requires 115Vac, 60Hz control power. A control box connected to the operator with a thirty-foot cord permits control from a remote location.

Description	Product Number
Remote Racker	EGRRLV

Lifting Device

Poles	Frame	Product Number
3	1 and 2	GLD3F12
3	3	GLD3F3
4	1 and 2	GLD4F12
4	3	GLD4F3
ACB Lifting Truck	-	ACBLIFT

For more accessories and options, see the EntelliGuard™ G Application Guide DET-653B.

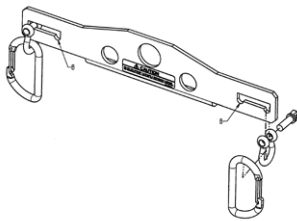

Frame 1 & 2,
3 Pole

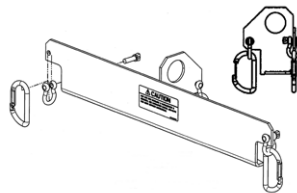

Frame 3,
3 Pole

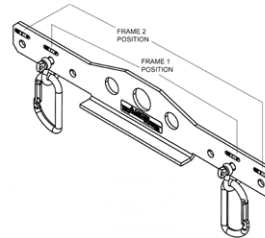

Frame 1 & 2,
4 Pole

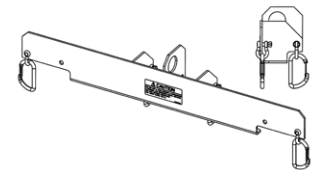

Frame 3,
4 Pole

OEM substructures and substructure accessories



OEM Switchgear Modules

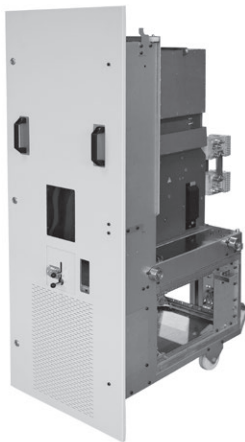

Drawout Trolley



Gerapid High-Speed Circuit Breaker

Switchgear Module and Trolley for use with Gerapid High-Speed DC Circuit Breakers

ABB offers UL recognized OEM switchgear modules and drawout trolleys for use with Gerapid High-Speed DC circuit breakers. Modules come factory assembled, and can be used to form lineups of DC switchgear. The OEM provides required bussing, wiring, controls and covers necessary to complete the switchgear. The Trolley is designed to accept Gerapid DC breakers, interface with the OEM Module and includes pre-wired secondary control harness and required interlocking.

Key Module Features include:

- NEMA 1, zinc-plated bolted steel frame construction
- 26" W x 87" H x 59" D
- Optional 71" depth for extra bus and cable space
- Rated for 800VDC, 200kA peak withstand
- Copper stationary primary stabs available for 2500A thru 6000A
- Side-covers and doors painted ANSI Grey
- Insulated safety shutters with padlock provisions
- Secondary control compartment with hinged, padlockable door
- 21.5" H x 22.8" W x 8.6" D
- Breaker secondary control wiring harness and plug included
- Designed to meet ANSI C37.20.1 requirements
- UL Recognized

Key Trolley Features include:

- Designed for use with Gerapid OEM Modules
- Complete drawout trolley for Gerapid UL Listed 2508 4008, 5008 and 6008 breakers
- Breaker secondary control wiring harness & socket included
- Breaker compartment door is hinged and fixed to trolley structure (dead front)
- Trolley front cover (door) has inspection window to view breaker position indicator and operations counter
- Trolley is grounded in all positions
- Designed to meet ANSI C37.20.1 and C37.14 interlocking and other requirements
- Standard manual racking drive
- Optional motor drive racking, 230VAC/60HZ
- UL Recognized

OEM Benefits

- Simplified OEM Modules (substructures)
- Complete drawout DC breaker solution
- Trolleys and Modules are UL recognized.
- Outlines available in PDF and as AutoCAD templates for OEMs
- All breaker controls prewired to secondary control disconnect
- ANSI C37.20.1 and C37.14 required interlocking included
- Accessories available, including various covers and hardware kits

OEM substructures and substructure accessories

Substructures

Description	Product Number
Gerapid OEM Module-4kA-1500mm	700689
Gerapid OEM Module-6kA-1500mm	700690
Gerapid OEM Module-4kA-1800mm	700691
Gerapid OEM Module-6kA-1800mm	700692

Breaker Trolley

Description	Product Number
Gerapid OEM Trolley-motor driven	700693
Gerapid OEM Trolley-manual drive	700694

Accessories

Description	Product Number
Racking Handle	700695
Rear Side Cover 1500mm Depth Unit	700696
Rear Side Cover 1800mm Depth Unit	700697
Control Wireway Connector	700698
Control Wireway Cover	700699
Section Bolting Hardware Kit	289158
Cover Attachment Hardware kit	289160
Door Hinges Kit	289709

To configure Gerapid OEM Modules and DC Circuit Breakers, visit our web\ wizard configuration tool at:
http://electrification.us.abb.com/cwc/Dispatcher?REQUEST=PRODUCTS&id=gerapid&lang=en_US

Trip units

EntelliGuard™ TU trip unit features

EntelliGuard™ TU Trip Unit

New capabilities in the EntelliGuard™ TU Trip Unit provide ultimate system reliability and selectivity without sacrificing circuit protection. This superior addition enhances the circuit breakers with a Waveform Recognition Instantaneous Algorithm that eliminates costly downtime due to nuisance tripping. It enables harmonic analysis four cycles prior and after an event, and discerns whether a downstream breaker/fuse is clearing the fault. The unit also includes Instantaneous Zone Selective Interlocking (I-ZSI) (can be used as a feeder and downstream device with a power circuit breaker upstream) which delivers simultaneous and independent ZSI of Short Time, Ground Fault and Instantaneous protection, providing the ability to overlap the Instantaneous on the Main and Feeder breakers. Together, these innovative abilities achieve HRC2 with currents as high as 100kA with simultaneous flash protection and selectivity.

The EntelliGuard™ TU Trip Unit offers optimum circuit safety and arc flash protection with the Reduced Energy Let-Through function, providing a faster instantaneous trip that may be used if faster and more sensitive protection is required temporarily. It is commonly referred to as an “Arc Flash Switch” or “Maintenance Switch”.

The new and improved trip unit design delivers selectivity tools not previously available in ABB circuit breakers:

Exclusive EntelliGuard™ TU Trip Unit Features

Designed for Flexibility

- A wide range of continuous adjustment Long Time delays ensure the circuit breaker can be exactly adjusted in to your selectivity and protection needs.
- Multiple Short Time diagonal bands tune your protection to exactly where it needs to be.
- Flexible time current settings and curves -Standard Long Time characteristics exactly mimic the curve of a thermal magnetic circuit breaker.
- Flexible Time Current Curves: 44 Long Time Shapes I^2T and I^4T (fuse), 3 Short Time I^2T slopes, Short Time adjustable in 55 ms increments, a Selective Ground Fault curve

Instantaneous Protection

- Instantaneous pick-up is adjustable up to 15 times the plug rating on frames 800-2000A, 13 times on 3000A frames and up to 9 times on 4000A frames.
- A separately adjustable fast instantaneous trip- useful for when the circuit must provide the best possible protection and arc flash performance while sustaining normal load.
- An override instantaneous - provides fast tripping for the largest bolted fault currents to minimize potential damage.
- Up to 17 Short Time bands allow you to set your circuit breaker to sustain load requirements without slowing protection.
- Ground Fault Alarm via I/O or Modbus Communications
- Ground fault protection with faster time bands, multiple slopes and the ability to coordinate a 1200A ground fault with an 800A circuit breaker – a ratio four times better than in previous generation trip units



Maintenance and Diagnostics

- Universal trip plug fits any trip unit.
- Flexible serial communication via Modbus RTU
- Integrates directly into ABB's EnerVista™ Power Management System.
- Large backlit LCD with detailed, easy-to-see descriptions.
- Health status via breaker LED indicating normal operation, errors, pickup, and trips while providing non-volatile memory with a continuous self-testing microprocessor
- Lithium battery to eliminate need for external power for set-up and review
- 10 event Log with Date/Time Stamp: Stores the last 10 events. Date/Time with 24Vdc Power.
- Thermal Memory
- WaveForm Capture: 40 Samples/Cycle, 4 cycles prior and 4 cycles post event in COMTrade format.
- Free set-up software

To learn more about EntelliGuard™ TU Trip Unit features see brochure DEA-461C.

Trip units

Power+ trip unit features

Power+ Trip Unit Systems

The Power+ trip unit system for insulated case circuit breakers consist of the trip unit, the trip actuator, current sensors and rating plugs. The term “trip unit system” applies to the combination of these four components which form the solid-state circuit breaker tripping system.

Power+ trip units provide a complete range of standard and optional overcurrent and ground-fault protective functions.



True RMS Sensing

The Power+ trip unit continues to use ABB’s proven technique of measuring true rms currents of both sinusoidal and harmonically distorted waveforms. The frequent sampling (48 times per cycle per phase) allows precise calculations of true rms current. The sampling rate allows waveform measurements up to the 11th harmonic. ABB’s true rms sensing avoids potential underprotection or overprotection problems associated with peak-sensing tripping systems.

Accessory Integration

Four accessories are integrated through the Power+ trip unit. Drop-in shunt trip (with or without lockout), bell alarms (with or without lockout) and the undervoltage release modules fit into keyed pockets. They operate through the trip units, and not through any external mechanisms. All accessory wiring is prewired to secondary terminals, and no user wiring is necessary. When activated, the shunt trip (with or without lockout) and undervoltage release modules send a signal to the trip unit to energize the trip actuator and open the breaker.

Trip Target Module (Optional)

View Button: Press the VIEW button to check the trip unit status.

Reset Button: Press the RESET button to clear any target that is set.

Battery check: Target modules use two standard, 3V, 16mm x 1.6mm, lithium batteries for viewing target information. Battery life depends upon use, but may be estimated at one year. When the batteries are energized, depressing the VIEW button will illuminate either a set target LED, i.e., LT or the BAT LED. Once target indicators are cleared, battery status is indicated by the BAT LED. Replacement batteries include Panasonic CR1616, Eveready E-CR1616BP, or Duracell DL1616B, which may be purchased commercially.



Power+ Trip Target Module

Long-time pickup: The long-time pickup indicator moves through two transitions. As the current in any phase reaches 95% of its setpoint; the LTPU LED begins to flash. As current increases, flashing frequency increases, until 100% of the pickup point is reached. At that moment, the LTPU LED stays on continuously until the long-time delay times out. Once the breaker has tripped on long-time, the OVL target will be stored in memory. To view the trip, press the VIEW button. To clear the target, press the RESET button.

Short-time and instantaneous trips: Short-time and instantaneous trips share the same trip target. The LTPU LED is not illuminated, since the time intervals between pickup and tripping are too short for either function. Once the breaker has tripped on short-time or instantaneous, the short target will be stored in memory. To view the trip, press the VIEW button. To clear the target, press the RESET button.

Ground fault trip (Target02 only): The trip target for a ground fault trip is the GF LED. To view the trip, press the view button. To clear the target, press the RESET button.

Health monitor: Trip unit health status “okay” is illustrated by slow blinking of the LTPU LED. It may be seen by depressing and holding the VIEW button. Sufficient power must be supplied to the trip unit via external test kit, power pack, or current transformers for the health monitor to be operational.

Standard and Optional Protective Functions

Standard and optional protective functions are available for Power+ trip units. The breaker settings are programmed in multiples of “X” (rating plug ampere values), “S” (current sensor ampere rating values), and “C” (the long-time setting in amperes—multiply long-time setting by rating plug ampere rating).

Standard

- Adjustable Long-Time (L) Pickup, 0.5 - 1.0X, with four delay bands.
- Adjustable Instantaneous (I) Pickup, 1.5 - 15X.1

Options

- Overload, Short Circuit, and Short-Time local trip indicators with overload pickup warning and health monitor.
- Adjustable Short-Time (S) Pickup, 1.5 - 9.0C, and delay (3 bands) with I²t ON/OFF selection.
- Adjustable Ground Fault (G) Pickup, 0.2 - 0.6S, and delay¹ (3 bands) with I²t ON/OFF selection and trip indicator.
- Upgradeable Ground Fault function with use of appropriate ground fault rating plug.

¹Limited by breaker frame size above 2000A.



Trip units

Enhanced MicroVersaTrip™ trip unit features

Enhanced MicroVersaTrip™ Trip Units

Enhanced MicroVersaTrip™ Plus and MicroVersaTrip™ PM trip units give you two new ways to monitor and control the circuit breaker with unprecedented ease. Through the simple keypad, the trip unit lets you program and display a variety of functions including tripping characteristics, remote communications, status information and protective relaying, and allows integration with ABB POWER LEADER™ Power Management Systems. The trip unit display also allows viewing of many standard metering parameters as well as pickup alarms, trip target indications and fault status information.

Enhanced MicroVersaTrip™ Plus and MicroVersaTrip™ PM trip units continue to use ABB's proven technique of measuring true rms currents (and voltages for MicroVersaTrip™ PM trip units) of both sinusoidal and harmonically distorted waveforms. The frequent sampling (64 times per cycle) allows precise calculations of true rms current. The sampling rate allows waveform measurements up to the 31st harmonic to achieve accuracies of 99%. ABB's true rms sensing avoids potential underprotection or overprotection problems associated with peak-sensing tripping systems. The enhanced trip unit design includes a wide range of functions and adds many new features::

UL Listed Field-Interchangeable

Non-volatile trip targets display/Cold setup capability

- Replaceable long-life batteries provide trip target indications and cold setup capability—without the need for external power or a battery pack.

Trip operations counter

- The number of long-time, short-time, instantaneous and ground fault trips are individually counted and displayed.

Trip information

- On overcurrent faults, the trip unit displays fault pickup, the type of fault, the magnitude of the fault current and the phase the fault occurred on.
- Display indicates when a shunt trip or undervoltage release trip has opened the breaker.

New display

- Ergonomic, 5-button keypad
- New targets with international symbols
- High-resolution LCD display for local 3-phase ammetering
- New status and setup displays for greater ease of use
- True rms sensing for accurate response to high harmonic content waveforms for Long-Time, Short-Time, and Ground Fault protection.
- 50/60 Hz operation.
- Interchangeable, UL Listed trip units and rating plugs with test set jack for TVRMS2 test set.
- EMI immunity per ANSI C37.90.

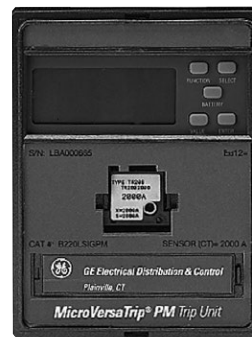

Enhanced MicroVersaTrip™ Plus and MicroVersaTrip™ PM Trip units have been specifically designed to integrate with the extensive capabilities offered by circuit breakers.

Features exclusive to MicroVersaTrip™ PM Trip Units

Communications

- All information can be viewed on the LCD display or communicated over a POWER LEADER™ Power Management System network.

Demand/peak demand

- The trip unit can display a rolling average of power demand and peak power demand at user-selected intervals from 5 to 60 minutes.

Local and remote metering

- Amps, volts, frequency

- Real power, total power

- Accumulated energy

Protective relays include:

- Current and voltage unbalance

- Overvoltage

- Undervoltage

- Power reversal

- Power reversal direction setup

Trip units

Trip unit characteristics

EntelliGuard™ TU Trip Unit Characteristics

Envelope Size	Frame Max. Ampere Rating	Sensor Rating (Amperes) (S)	Long Time			Short Time	
			Current Setting (C) (Pick-Up) Multiple of Rating Plug Amperes (X)	Delay (Seconds) ¹		Pick-up (Multiple of Current Settings) (C)	Delay (seconds)
				Fuse Type (F-Bands)	Thermal Type (C-Bands)		
800	800	200, 400, 800	0.5 thru 1.0 in Increments of 0.05	0.025	0.20	1.5 thru 9.0 in Increments of 0.5	I ² T in Minimum - 0.046 Intermediate - 0.186 Maximum - 0.418 ¹
1600	1600	800, 1000, 1600		0.025	0.60		
				0.025	1.21		
				0.032	1.61		
				0.044	2.41		
				0.059	3.21		
2000	2000	2000		0.078	4.02		
				0.10	4.82		
				0.13	5.62		
				0.17	6.43		
				0.22	7.23		
3000	2500	1000, 2000, 2500		0.27	8.04		
	3000	3000		0.35	9.64		
				0.44	11.20		
				0.55	12.90		
				0.69	14.50		
4000	4000	4000		0.87	16.10		
				1.10	17.70		
				-	19.30		
			-	-			

Trip Unit Characteristics (continued)

Envelope Size	Adjustable Instantaneous Pick-Up without ST (Multiple of Rating Plug Amperes) (X)	Adjustable Instantaneous Pick-Up with ST (Multiple of Rating Plug Amperes) (X)	RELT without ST	RELT with ST	Pick-Up (Multiple of Sensor Ampere Rating)	Ground Fault ³		
						Delay with I ² T in Seconds	Slope Bands	Fixed Delay
800	2.0 thru 10.0 in 0.5 increments	2.0 thru 15.0 in 0.5 increments	1.5 thru 10.0 in 0.5 increments	1.5 thru 15.0 in 0.5 increments	0.20 thru 0.60 in increments of 0.01	.44 at 200% of pick-up at lower limit of band	I ² T - .385 I ⁴ T - .179 SGF - .553	0.058
1600	2.0 thru 10.0 in 0.5 increments	2.0 thru 15.0 in 0.5 increments	1.5 thru 10.0 in 0.5 increments	1.5 thru 15.0 in 0.5 increments	0.20 thru 0.60 in increments of 0.01			0.092
2000	2.0 thru 10.0 in 0.5 increments	2.0 thru 15.0 in 0.5 increments	1.5 thru 10.0 in 0.5 increments	1.5 thru 15.0 in 0.5 increments	0.20 thru 0.60 in increments of 0.01			0.117
3000	2.0 thru 10.0 in 0.5 increments	2.0 thru 13.0 in 0.5 increments	1.5 thru 10.0 in 0.5 increments	1.5 thru 13.0 in 0.5 increments	0.20 thru 0.37 in increments of 0.01			0.158
								0.217
4000	2.0 thru 9.0 in 0.5 increments	2.0 thru 9.0 in 0.5 increments	1.5 thru 9.0 in 0.5 increments	1.5 thru 9.0 in 0.5 increments	0.20 thru 0.30 in increments of 0.01	0.35		

¹Time delay shown at 600% of current setting at lower limit of band.
²Time delay shown at lower limit of each band. All pick-up tolerances are ±10%.
³Time delay shown at lower limit of each band. Ground fault pick-up not to exceed 1200 amperes

Additional Features and Characteristics of the EntelliGuard™ TU Trip Unit

Function	Description	Product Number Digit														
		1	2	3	4	5	6	7	8	9	X	A ⁴	B ⁴	C ⁴	D ⁴	E ⁴
Metering																
Communications	Modbus Communications Bus Link															
Amperes (A, kA) ²	Selectable Phase Current ±2.5%	•	•			•	•		•			•				•
Voltage (V)	L-L or L-N Volts ±1.5%				•	•	•		•				•	•	•	•
Energy (kWh, Mwh, GWh)	Total Energy Usage on Brkr ±4%				•	•	•		•				•	•	•	•
Real Power (kW/MW)	L-L or L-N Power ±4%				•	•	•		•				•	•	•	•
Total Power (kVA/MVA)	L-L or L-N Power ±4%				•	•	•		•				•	•	•	•
Frequency (Hz)	Circuit Frequency ±1Hz				•	•	•		•				•	•	•	•
Demand & Peak Demand (kW)	-				•	•	•		•				•	•	•	•
Relaying																
Under Voltage Trip	Adjustable pickup, 50-90% Adjustable delay, 1-15 seconds OFF						•									•
Over Voltage Trip	Adjustable pickup, 110-150% Adjustable delay, 1-15 seconds OFF						•									•
Voltage Unbalance	Adjustable pickup, 10-50% Adjustable delay, 1-15 seconds OFF						•									•
Current Unbalance	Adjustable pickup, 10-990kW Adjustable delay, 1-15 seconds Off Power Reversal Direction						•									•
Data Acquisition - Waveform Capture																
RELT		•	•		•	•	•		•							•

⁴Used when Ground Fault Alarm is needed via the output contact

Trip units

Trip unit characteristics (continued)

Additional Features and Characteristics of the EntelliGuard™ TU Trip Unit

Product No. Digits	Zone Selective Interlocking	Circuit Breaker
Z	ZSI, Short time and GF; user selectable	•
T	Z + IOC ZSI; user selectable	• ¹
X	NONE SELECTED	•

¹Instantaneous out only

Power+ Trip Unit Characteristics

Envelope Size	Frame Max. Ampere Rating	Sensor Rating (Amperes) (S)	Long-Time		Short-Time	
			Current Setting (C) (Pick-Up Multiple of Rating Plug Amperes) (X)	Delay ² (Seconds 4 Bands)	Pick-up (Multiple of Current Setting) (C)	Delay (Seconds 3 Bands)
2000	800	200, 400, 800	0.5, 0.6, 0.7, 0.8, 0.9, 0.95 and 1.0	2.4, 4.9, 9.8, 20	1.5, 2.0, 2.5, 3.0, 4.0, 5.0, 7.0, and 9.0	I^2T in ² .10, .21, .35
	1600	800, 1000, 1600				
	2000	2000				I^2T out ³ .10, .21, .35
3000	2500, 3000	1000, 2000, 2500, 3000				
4000	4000	4000				

Power+ Trip Unit Characteristics (continued)

Envelope Size	Adjustable Instantaneous Pick-Up without ST (Multiple of Rating Plug Amperes) (X)	Adjustable Instantaneous Pick-Up with ST (Multiple of Rating Plug Amperes) (X)	Ground Fault	
			Pick-Up (Multiple of Sensor Ampere Rating)	Delay ⁴ (Seconds 3 Bands)
2000	1.5 thru 10.0	1.5 thru 15.0	0.20 thru 0.60	I^2T in ⁵ .10, .21, .35
	1.5 thru 10.0	1.5 thru 15.0	0.20 thru 0.60	
	1.5 thru 10.0	1.5 thru 15.0	0.20 thru 0.60	I^2T out ³ .10, .21, .35
3000	1.5 thru 10.0	1.5 thru 13.0	0.20 thru 0.37	
4000	1.5 thru 9.0	1.5 thru 9.0	0.20 thru 0.30	

Enhanced MicroVersaTrip™ Plus and PM Trip Unit Characteristics

Envelope Size	Frame Max. Ampere Rating	Sensor Rating (Amperes) (S)	Long-Time		Short-Time	
			Current Setting (C) (Pick-Up Multiple of Rating Plug Amperes) (X)	Delay ³ Seconds	Pick-up (Multiple of Current Setting) (C)	Delay Seconds
800	800	200, 400, 800	0.5 thru 1.0 in increments of 0.05	2.4, 4.9, 9.8, 20	1.5 thru 9.0 in increments of 0.5	I^2T in ² 0.40
1600	1600	800, 1000, 1600				
2000	2000	2000				I^2T out ³ .10, .21, .35
3000	2500	1000, 2000, 2500				
	3000	3000				
4000	4000	4000				

Trip Unit Characteristics (continued)

Envelope Size	Adjustable Instantaneous Pick-Up without ST (Multiple of Rating Plug Amperes) (X)	Adjustable Instantaneous Pick-Up with ST (Multiple of Rating Plug Amperes) (X)	High Range Instantaneous (Multiple of Frame Short-Time Rating) (H)	Ground Fault		
				Pick-Up (Multiple of Sensor Ampere Rating)	Delay With I^2T In Seconds	Delay ⁴ With I^2T Out Seconds
800	1.5 thru 10.0 in 0.5 increments	1.5 thru 15.0 in 0.5 increments	1.0	0.20 thru 0.60 in increments of 0.01	.44 at 200% of pick-up at lower limit of band	.10, .21, .35
1600	1.5 thru 10.0 in 0.5 increments	1.5 thru 15.0 in 0.5 increments		0.20 thru 0.60 in increments of 0.01		
2000	1.5 thru 10.0 in 0.5 increments	1.5 thru 15.0 in 0.5 increments		0.20 thru 0.60 in increments of 0.01		
3000	1.5 thru 10.0 in 0.5 increments	1.5 thru 13.0 in 0.5 increments		0.20 thru 0.37 in increments of 0.01		
4000	1.5 thru 9.0 in 0.5 increments	1.5 thru 9.0 in 0.5 increments		0.20 thru 0.30 in increments of 0.01		

²Time delay shown at 600% of current setting at lower limit of band.

³Time delay shown at lower limit of each band. All pick-up tolerances are $\pm 10\%$.

⁴Time delay shown at lower limit of each band. Ground fault pick-up not to exceed 1200 amperes.

⁵Time delay shown at 200% of pick-up at lower limit of band.

X = Rating plug amps

S = Sensor amp rating

C = Long-time current setting (pick-up)

H = Short-Time Rating

Trip units

Trip unit characteristics (continued)

Additional Features and Characteristics Exclusive to the Enhanced MicroVersaTrip™ PM Trip Unit¹

Function	Description	Trip Unit Suffix		
		M (Metering)	P (Relaying)	PM (Metering & Relaying)
Communications	POWER LEADER Communications Bus Link	STD	STD	STD
Amperes (A, kA) ²	Selectable Phase Current ±2.5%	STD	STD	STD
Voltage (V)	L-L or L-N Volts ±1.5%	•		•
Energy (kWh, MWh, GWh)	Total Energy Usage on Brkr ±4%	•		•
Real Power (kW/MW)	L-L or L-N Power ±4%	•		•
Total Power (kVA/MVA)	L-L or L-N Power ±4%	•		•
Frequency (Hz)	Circuit Frequency ± 1Hz	•		•
Demand & Peak Demand (kW)		•		•
Under Voltage Trip	- Adjustable pickup 50-90% - Adjustable delay, 1-15 seconds OFF		•	•
Over Voltage Trip	- Adjustable pickup, 110-150% - Adjustable delay, 1-15 seconds OFF		•	•
Voltage Unbalance	- Adjustable pickup, 10-50% - Adjustable delay, 1-15 seconds OFF		•	•
Current Unbalance	- Adjustable pickup, 10-50% - Adjustable delay, 1-15 seconds OFF		•	•
Power Reversal	- Adjustable pickup, 10-990 kW - Adjustable delay, 1-15 seconds OFF - Power Reversal Direction		• •	• •

¹MicroVersaTrip™ PM functions require 24 Vdc control power.

²Ampere reading also standard on MicroVersaTrip™ Plus trip units.

Trip units

Product number nomenclature system

EntelliGuard™ TU Trip Unit for EntelliGuard™ G Breakers Product Number Structure

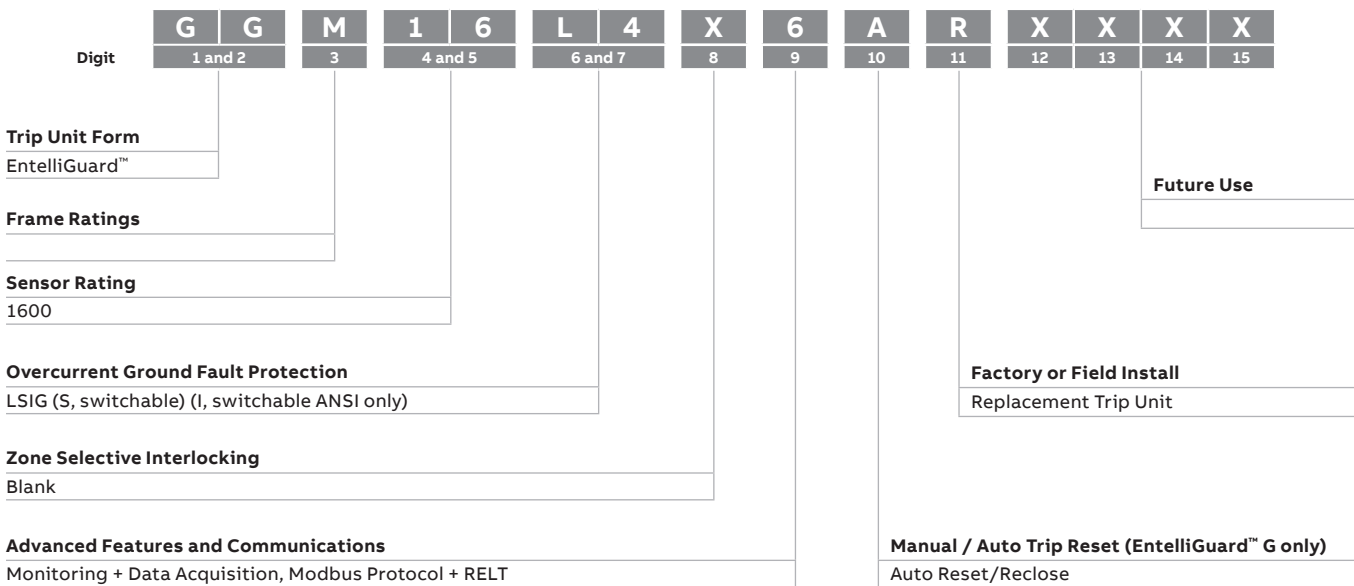

Digit 1 and 2 Trip Unit Form/Family

Circuit Breaker Type	Code
Power Break™ I (UL)	GA
Power Break™ II (UL)	GB
AKR (ANSI)	GC
WP (ANSI)	GW
Mpact Low (IEC)	GL
Mpact 24-48V (IEC)	GH
Mpact 120-240V (IEC)	GQ
EntelliGuard™ G ACB (ANSI)	GG
EntelliGuard™ G ACB (UL)	GU
EntelliGuard™ G ACB (IEC)	GT
EntelliGuard™ G Universal Spare Trip	G1
Type A Conversion Kits (ANSI)	G2
EntelliGuard™ G Switch (IEC)	G3

Digit 4 and 5 Sensor Rating

Sensor Rating	Code
UNIV ¹	00
400	04
600 ²	06
800	08
1000 ²	10
1200 ²	12
1600	16
2000	20
2500 ²	25
3000 ²	30
3200 ³	32
4000	40
5000	50
6000 ²	60

¹Universal Spare Trip Unit (Digit 3 = X)

²UL Only

³ANSI Only

Digit 3 EntelliGuard™ G Frame Ratings

Interrupting Rating Tier ANSI/UL1066 Devices, LVPCB							
Code	254V	580V	635V	1/2S Withstand	HSIOC	Override No. 1	Override WI
S	65,000	65,000	50,000	50,000	50,000	49,000	53,500
N	65,000	65,000	65,000	65,000	None	None	None
H	85,000	85,000	65,000	65,000	65,000	63,700	69,500
E	85,000	85,000	85,000	85,000	None	None	None
M	100,000	100,000	100,000	85,000	85,000	83,800	90,950
B	100,000	100,000	100,000	100,000	None	None	None
L	150,000	150,000	100,000	100,000	100,000	98,000	107,000
Interrupting Rating Tier UL489 Devices ICCB							
Code	240V	480V	600V	1/2S Withstand	HSIOC	Override No. 1	Override WI
S	65,000	65,000	50,000	42,000	42,000	N/A	44,940
N	65,000	65,000	65,000	42,000	42,000	N/A	44,940
H	85,000	85,000	65,000	50,000	50,000	N/A	53,500
M	100,000	100,000	100,000	65,000	65,000	N/A	69,550
L	150,000	150,000	100,000	85,000	85,000	N/A	90,950

Refer to ABBH-4567 for other Circuit Breaker Types

Trip units

Product number nomenclature system

Digit 6 and 7 Overcurrent Protection Package

Type		Over Current (OC) Protection Package	Code
EntelliGuard™ G ANSI/UL OC Protection	Standard Range Instantaneous	LSI (S, switchable) (I, switchable ANSI only)	L3
		LSIG (S, switchable) (I, switchable ANSI only)	L4
		LSIGA (S, switchable) (I, switchable ANSI only) (G, Alarm Only)	L5
		LSIC (S, switchable) (I, switchable ANSI only)	L6
		LSICA (S, switchable) (I, switchable ANSI only) (C, Alarm Only)	L7
		LSIGDA ¹ (S, G, A switchable) (I, switchable ANSI only)	L8
	Extended Range Adjustable Instantaneous	LSIGCDA ¹ (S, G, C, A all switchable) (I, switchable ANSI only)	L9
		LSH (S, switchable) (I, switchable ANSI only)	LC
		LSHG (S, switchable) (I, switchable ANSI only)	LD
		LSHGA (S, switchable) (I, switchable ANSI only) (G, Alarm Only)	LE
		LSHC (S, switchable) (I, switchable ANSI only)	LF
		LSHCA (S, switchable) (I, switchable ANSI only) (C, Alarm Only)	LG
		LSHGDA ¹ (S, G, A switchable) (I, switchable ANSI only)	LH
		LSHGCDA ¹ (S, G, C, A all switchable) (I, switchable ANSI only)	LK

¹Function Combination is NOT UL Listed

NOTES:

- L = Long Time (L, I²T) + Fuse Settings (I⁴T) (Fuse settings are now standard on all EntelliGuard™ Trip Units)
- S = Short Time (Switchable if Instantaneous (I) protection is enabled)
- I = Standard Range Adjustable Instantaneous, (IOC, 2x-15x)
- H = Extended Range Adjustable Instantaneous, (IOC, 2x-30x), Only for ANSI EntelliGuard™ G
- G = Ground Fault Protection (GFP, 3-wire or 4-wire, internal summing) Trip and Alarm
- C = External CT for ground fault detection (AKD20 application: input from external summing CTs, used for multiple source ground fault detection. OEM Application: Zero Sequence Input of 1A = 100%)
- D = Defeatable/Switchable Ground Fault, NOT UL Listed
- A = Ground Fault, External Ground Fault, Alarm only
- GA = Ground Fault Alarm Only
- CA = External Ground Fault Alarm Only
- GDA, GCDA = Ground Fault Trip and Ground Fault Alarm (all switchable, Not UL Listed)

Digit 8 Zone Selective Interlocking (ZSI)

Zone Selective Interlocking	Code
ZSI, Short time and GF; user selectable	Z
Z+IOC or HIOC ZSI; user selectable	T
Blank/none	X

ZSI selections require Secondary Disconnect Block B and 24Vdc control power.
NOTE: Option X is the only valid item when a Switch is selected in Digit 2.

Digit 9 Advanced Features and Communications

Advanced Features and Communications	Code
Reduced Energy Let-Through (RELT)	1
Modbus Protocol + RELT	2
Profibus Protocol + RELT	3
Monitoring + RELT, NO Communication	4
Monitoring + Relay Package + RELT	5
Monitoring + Data Acquisition, Modbus Protocol + RELT	6
Monitoring + Data Acquisition, Profibus Protocol + RELT	7
Monitoring + Data Acquisition + Relay Package, Modbus + RELT	8
Monitoring + Data Acquisition + Relay Package, Profibus + RELT	9
NONE	X

NOTES:

- All Advanced Feature selections require Secondary Disconnect Block B and 24Vdc control power
- RELT = Reduced Energy Let Through
- Monitoring = Advanced Metering
- Data Acquisition = Waveform Capture and Harmonic Analysis

Digit 10 Manual/Auto Trip Reset

Manual/Auto Trip Reset	Code
Manual Lockout	M
Auto Reset/Reclose	A
Auto/Manual Lockout (Selectable) ²	S ²
None (Defaults to Auto Reset/Reclose)	X

Note: When Bell Alarm with Lockout is selected on the EntelliGuard™ G Circuit Breaker, then Code M must be selected
X is only valid on ABB Legacy Circuit Breakers and Conversion Kits
M is valid on EntelliGuard™ G Breakers when a Bell Alarm is selected
A is valid on EntelliGuard™ G Breakers when a Bell Alarm is not selected
²S is IEC Only

Digit 11 Factory or Field Installed

Manual/Auto Trip Reset	Code
Factory Installed Trip Unit (Original)	F
Replacement Trip Unit (shipped loose)	R

Trip units

Product number nomenclature system

EntelliGuard™ TU Trip Unit for Power Break™, AK/AKR, Conversion Kit Breakers Product Number Structure

Digit	G 1 and 2	B 3	2 4 and 5	1 6 6 and 7	L 4 8	X 9	6 10	X 11	R 12	X 13	X 14	X 15
Trip Unit Form Break™ II Power											Future Use	
Frame Ratings 1600 Amp Frame												
Sensor Rating 1600												
Overcurrent Ground Fault Protection LSIG (S, switchable) (I, switchable ANSI only)												
Zone Selective Interlocking Blank												
Advanced Features and Communications Monitoring + Data Acquisition, Modbus Protocol + RELT												
									Original / Replacement Trip Unit F = Factory Installed (Original) R = Replacement (Field Installed)			
									Manual / Auto Trip Reset A, M, or S = EntelliGuard™ G only X = for all others			

Digit 1 and 2 Trip Unit Form/Family

Circuit Breaker Type	Code
Power Break™ I (UL)	GA
Power Break™ II (UL)	GB
AK, AKR (ANSI)	GC
WP (ANSI)	GW
Mpact Low (IEC)	GL
Mpact 24-48V (IEC)	GH
Mpact 120-240V (IEC)	GQ
EntelliGuard™ G ACB (ANSI)	GG
EntelliGuard™ G ACB (UL)	GU
EntelliGuard™ G ACB (IEC)	GT
EntelliGuard™ G Universal Spare Trip	G1
Type A Conversion Kits (ANSI)	G2
EntelliGuard™ G Switch (IEC)	G3

Digit 4 and 5 Sensor Rating

Sensor Rating	Code
150	01
200	02
225	03
400	04
600	06
800	08
1000	10
1200	12
1600	16
2000	20
2500	25
3000	30
3200	32
4000	40
5000	50

Sensor must be equal to or less than Frame Rating

Digit 3 Legacy Frame Rating by Breaker Type

Code 3	Frame Rating	Breaker Type		
		Power Break™ I and II	AKR	AK, Westinghouse, ITE, Allis Chalmers
A	225A			•
C	600A			•
0 ¹	800A (AKR30S)		•	
1	800A	•	•	•
2	1600A	•	•	•
3	2000A	•	•	•
4	2500A	•		
5	3000A	•	•	•
6	3200A		•	•
7	4000A	•	•	•
8	5000A			

¹0 is used for only AKR30S breakers

Trip units

Product number nomenclature system

Digit 6 and 7 Overcurrent Protection Package

Type		Over Current (OC) Protection Package	Code
Legacy ANSI/UL OC Protection	PB1 and PBII, AK, AKR, Conv Kits	LSI (S, switchable) (I, switchable ANSI only)	L3
		LSIG (S, switchable) (I, switchable ANSI only)	L4
		LSIGA (S, switchable) (I, switchable ANSI only) (G, Alarm Only)	L5
		LSIGDA ¹ (S, G, A switchable) (I, switchable ANSI only)	L8

¹Function Combination is NOT UL Listed

NOTES:

L = Long Time (L, I²T) + Fuse Settings (I⁴T) (Fuse settings are now standard on all EntelliGuard™ Trip Units)
 S = Short Time (Switchable if Instantaneous (I) protection is enabled)
 I = Standard Range Adjustable Instantaneous, (IOC, 2x-15x)

G = Ground Fault Protection (GFP, 3-wire or 4-wire, internal summing), Trip and Alarm
 D = Defeatable/Switchable Ground Fault, NOT UL Listed
 A = Ground Fault, Alarm only
 GA = Ground Fault Alarm Only
 GDA = Ground Fault Trip and Ground Fault Alarm (all switchable, Not UL Listed)

Digit 8 Zone Selective Interlocking (ZSI)

Zone Selective Interlocking	Code
ZSI, Short time and GF; user selectable	Z
ZSI, Instantaneous, Short Time, and Ground Fault; user selectable	T
Blank/none	X

All ZSI selections require a special harness (contact factory) and 24Vdc control power. ZSI Instantaneous (T), Power Break™ can only be used as a Feeder (ZSI-I out)

Digit 11 Original/Replacement Trip Unit

Original/Replacement	Code
Factory Installed (Original)	F
Replacement (Field Installed)	R

Digit 9 Advanced Features and Communications

Advanced Features and Communications	Digit 9	WP	PBII	AKR	Conv Kits
NONE (Ammeter)	X	x	x		x
Ammeter, Reduced Energy Let-Through (RELT)	1	x	x	x	x
Ammeter, Modbus Protocol + RELT	2		x		
Monitoring + Data Acquisition, Modbus Protocol + RELT	6	x	x	x	
Monitoring + Data Acquisition + Relay Package, Modbus + RELT	8	x	x	x	x
Ammeter, Modbus Protocol (Without RELT)	A		x		
Monitoring + Data Acquisition, Modbus Protocol (without RELT)	D	x	x	x	
Monitoring + Data Acquisition + Relay Package, Modbus (without RELT)	E	x	x	x	x

NOTES:

All Advanced Feature selections require 24Vdc control power
 RELT = Reduced Energy Let Through (Harness may be required, contact factory)
 Monitoring = Advanced Metering (Harness may be required, contact factory)
 Data Acquisition = Waveform Capture and Harmonic Analysis
 Options A, D, E are available when Ground Fault Alarm is selected

EntelliGuard™ TU

Circuit Breaker Type	Code 1 and 2
All Circuit Breakers	G

OC Protection Package	Code 6 and 7
LSI (S, switchable) (I, switchable ANSI only)	L3
LSIG (S, switchable) (I, switchable ANSI only)	L4
LSIGA (S, switchable) (I, switchable ANSI only)	L5
LSIGDA ² (S, G, A all switchable) (I, switchable ANSI only)	L8
JSI (S, switchable) (I, switchable ANSI only)	J3
JSIG (S, switchable) (I, switchable ANSI only)	J4
JSIGA (S, switchable) (I, switchable ANSI only)	J5
JSIGDA ¹ (S, G, A all switchable) (I, switchable ANSI only)	J8

Zone Selective Interlocking	Code 8
None Selected	X
ZSI, Short time and GF; user selectable	Z
Z + IOC or HSIIOC ZSI; user selectable	T

Digit 10 Manual/Auto Trip Reset

Manual/Auto Trip Reset	Code
Manual Reset (ANSI/UL EntelliGuard™ G Only)	M
Automatic Reset (ANSI/UL EntelliGuard™ G Only)	A
Automatic Reset (IEC EntelliGuard™ G Only)	S
Not Applicable (Power Break™, Power Break™ II, AKR, Conv Kits)	X

Advanced Features and Communications	Code 9
None Selected	X
Reduced Energy Let-Through (RELT)	1
Modbus Protocol Only	2
Monitoring Only	4
Monitoring + Relay Package	5
Monitoring + Data Acquisition, Modbus Protocol	6
Monitoring + Data Acquisition + Relay Package, Modbus	8

¹Function Combination is NOT UL Listed

Trip units

Product number nomenclature system

EntelliGuard™ TU Trip Unit Rating Plug Product Numbers

		GTP	1100	U	12	25			
Trip Unit Type Rating						Largest Current Sensor Rating			
GTP = Trip unit rating plug EntelliGuard™ TU Trip Unit						01 = 150A 16 = 1600A			
						02 = 200A 20 = 2000A			
						03 = 225A 25 = 2500A			
						04 = 400A 30 = 3000A			
						06 = 600A 32 = 3200A			
						07 = 630A 40 = 4000A			
						08 = 800A 50 = 5000A			
						10 = 1000A 60 = 6000A			
						12 = 1200A 64 = 6400A			
						13 = 1250A			
Rating Plug Ampere Rating						Smallest Current Sensor Rating			
0060 = 60A	1000 = 1000A					01 = 150A 16 = 1600A			
0080 = 80A	1100 = 1100A					02 = 200A 20 = 2000A			
0100 = 100A	1200 = 1200A					03 = 225A 25 = 2500A			
0125 = 125A	1500 = 1500A					04 = 400A 30 = 3000A			
0150 = 150A	1600 = 1600A					06 = 600A 32 = 3200A			
0200 = 200A	1700 = 1700A					07 = 630A 40 = 4000A			
0225 = 225A	1800 = 1800A					08 = 800A 50 = 5000A			
0250 = 250A	1900 = 1900A					10 = 1000A 60 = 6000A			
0300 = 300A	2000 = 2000A					12 = 1200A 64 = 6400A			
0350 = 350A	2200 = 2200A					13 = 1250A			
0400 = 400A	2400 = 2400A								
0450 = 450A	2500 = 2500A								
0500 = 500A	3000 = 3000A								
0600 = 600A	3200 = 3200A								
0700 = 700A	3600 = 3600A								
0750 = 750A	4000 = 4000A								
0800 = 800A	5000 = 5000A								
0900 = 900A	6000 = 6000A								
Trip Unit Type									
U = Universal Trip Plug									

Trip units

Product number nomenclature system

Power+ Trip Unit and Power Break II Product Numbers

D2	20	LSI	T1	R ¹
Trip Unit Type and Rating D2 = Power Break™ II Power+ Trip Unit: 2000 A sensor maximum D3 = Power Break™ II Power+ Trip Unit: 3000 A sensor maximum D4 = Power Break™ II Power+ Trip Unit: 4000 A sensor maximum				Replacement or New R = Replacement trip unit (Blank) = New
Current Sensor Rating 02 = 200 A 20 = 2000 A 04 = 400 A 25 = 2500 A 08 = 800 A 30 = 3000 A 10 = 1000 A 40 = 4000 A 16 = 1600 A				Trip unit options T1 = Target Module without ground fault target T2 = Target Module with ground fault target (Blank) = Factory Installed
				Auxiliary functions LI = Long-time and Instantaneous LSI = Long-time, Short-time, Instantaneous

¹Device Product Number requires an extender "R" for field installable kit version only.
 NOTE: This information is provided only for use interpreting product numbers. It cannot be used to build product numbers.

Power+ Rating Plug Product Numbers

TR	10	C	800	GF
Trip Unit Type and Rating TR = Trip unit rating plug All Power+, MicroVersaTrip™ Plus, and MicroVersaTrip™ PM rating plugs			Ground Fault Function Blank = No ground fault GF = Ground fault	
Current Sensor Rating 02 = 200 A 20 = 2000 A 04 = 400 A 25 = 2500 A 08 = 800 A 30 = 3000 A 10 = 1000 A 40 = 4000 A 16 = 1600 A			Rating Plug Ampere Rating 100 = 100 A 800 = 800 A 150 = 150 A 1000 = 1000 A 200 = 200 A 1100 = 1100 A 225 = 225 A 1200 = 1200 A 250 = 250 A 1500 = 1500 A 300 = 300 A 1600 = 1600 A 400 = 400 A 2000 = 2000 A 450 = 450 A 2500 = 2500 A 500 = 500 A 3000 = 3000 A 600 = 600 A 3600 = 3600 A 700 = 700 A 4000 = 4000 A	
Trip Unit Type C=Power+ trip unit rating plugs				

Power+ Target Module Product Numbers
 TARGET00 = Blank insert for Target Module
 TARGET01 = Target Module without ground fault target
 TARGET02 = Target Module with ground fault target

NOTE: This information is provided only for use interpreting product numbers. It cannot be used to build product numbers.

Trip units

Product number nomenclature system

MicroVersaTrip™ Plus, MicroVersaTrip™ PM Trip Unit and Power Break II Product Number

B2		20		LSI		GZ1		PM		R ¹	
Trip Unit Type and Rating						Remanufactured					
B2 = Power Break II Enhanced MicroVersa Trip Plus™ or PM Trip Unit: 2000 A Sensor maximum						RM = Remanufactured Trip Unit					
B3 = Power Break™ II Enhanced MicroVersaTrip Plus™ or PM Trip Unit: 3000 A Sensor maximum						RX = Exchanged Trip Unit					
B4 = Power Break™ II Enhanced MicroVersaTrip Plus™ or PM Trip Unit: 4000 A Sensor maximum						Trip unit options					
Current Sensor Rating						Options for MicroVersaTrip PM trip units only. Must select one:					
02 = 200 A 20 = 2000 A						P = Protective relays & communications					
04 = 400 A 25 = 2500 A						M = Metering & communications					
08 = 800 A 30 = 3000 A						PM = Protective relays, metering, & communications					
10 = 1000 A 40 = 4000 A						(Blank) = MicroVersaTrip™ Plus trip unit					
16 = 1600 A						Ground Fault Functions					
Auxiliary Functions						G = Ground fault					
LI = Long-time and instantaneous						GD = Ground fault defeatable (not UL listed)					
LSI = Long-time, short-time, instantaneous						GZ1 = Ground fault; zone selective interlocking for ground fault only					
LSH = Long-time, short-time, high-range instantaneous						GZ2 = Ground fault and short-time selective interlock					
						GDZ2 = Ground fault defeatable (not UL listed): ground fault and short-time selective interlock					
						(Blank) = None					

¹Device Product Number requires an extender "R" for field installable kit version only.

NOTE: This information is provided only for use interpreting product numbers. It cannot be used to build product numbers.

Rating Plug Product Numbers (MicroVersaTrip™ Plus and PM)

TR		10		B		800					
Device Type						Rating Plug Ampere Rating					
TR = Trip unit rating plug All Power+, MicroVersaTrip™ Plus, and MicroVersaTrip™ PM rating plugs						100 = 100 A 1000 = 1000 A					
Current Sensor Rating						150 = 150 A 1200 = 1200 A					
2 = 200 A 20 = 2000 A						200 = 200 A 1500 = 1500 A					
4 = 400 A 25 = 2500 A						225 = 225 A 1600 = 1600 A					
8 = 800 A 30 = 3000 A						300 = 300 A 2000 = 2000 A					
10 = 1000 A 40 = 4000 A						400 = 400 A 2500 = 2500 A					
16 = 1600 A						500 = 500 A 3000 = 3000 A					
Trip Unit Type						600 = 600 A 3600 = 3600 A					
B = All Enhanced MicroVersaTrip™ Plus and MicroVersaTrip™ PM trip unit rating plugs						700 = 700 A 4000 = 4000 A					
						800 = 800 A					

NOTE: This information is provided only for use interpreting product numbers. It cannot be used to build product numbers.

Trip units

Product number nomenclature system

MicroVersaTrip™ Plus, MicroVersaTrip™ PM Trip Unit and Power Break Product Number

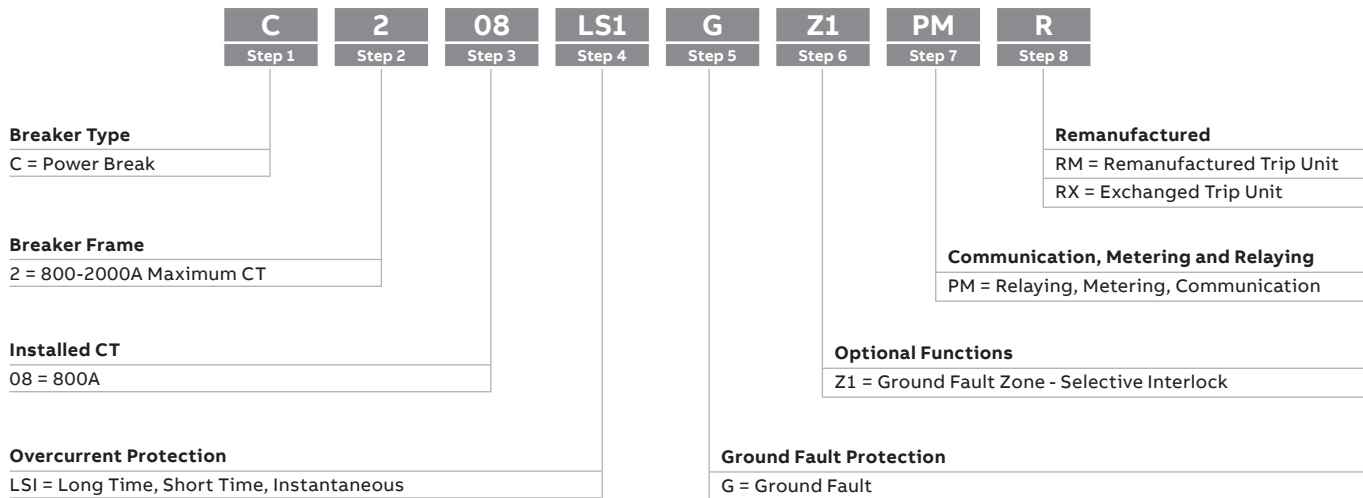

MVT PLUS/PM - PowerBreak

Step 1 Breaker Type

Breaker Type	Code
Power Break	C

Step 2 Breaker Frame

Frame Size (max CT)	Code
800-2000A	2
3000A	3
4000A	4

Step 3 Installed CT

Installed CT	Code
200A	02
400A	04
600A	06
800A	08
1000A	10
1600A	16
2000A	20
2500A	25
3000A	30
4000A	40

Step 4 Overcurrent Protection

Overcurrent Protection	Code
Long-Time (Standard)	L
Short-Time	S
High Instantaneous	H
Instantaneous	I

Step 5 Ground Fault Protection

Ground Fault Protection	Code
Ground Fault	G
Defeatable ground fault (user defeatable)	GD

Step 6 Optional Functions

Optional Protection	Code
Ground-Fault zone -selective interlock	Z1
Ground-Fault and short-time ZSI	Z2

Step 7 Communication, Metering and Relaying

Communication, Metering and Relaying	Code
Relaying and Communication	P
Metering and Communication	M

Step 8 Remanufactured

Remanufactured	Code
Remanufactured trip unit	RM
Exchanged trip unit	RX

Trip units

Product number nomenclature system

MicroVersaTrip™ Plus, MicroVersaTrip™ PM Trip Unit and AKR Product Number

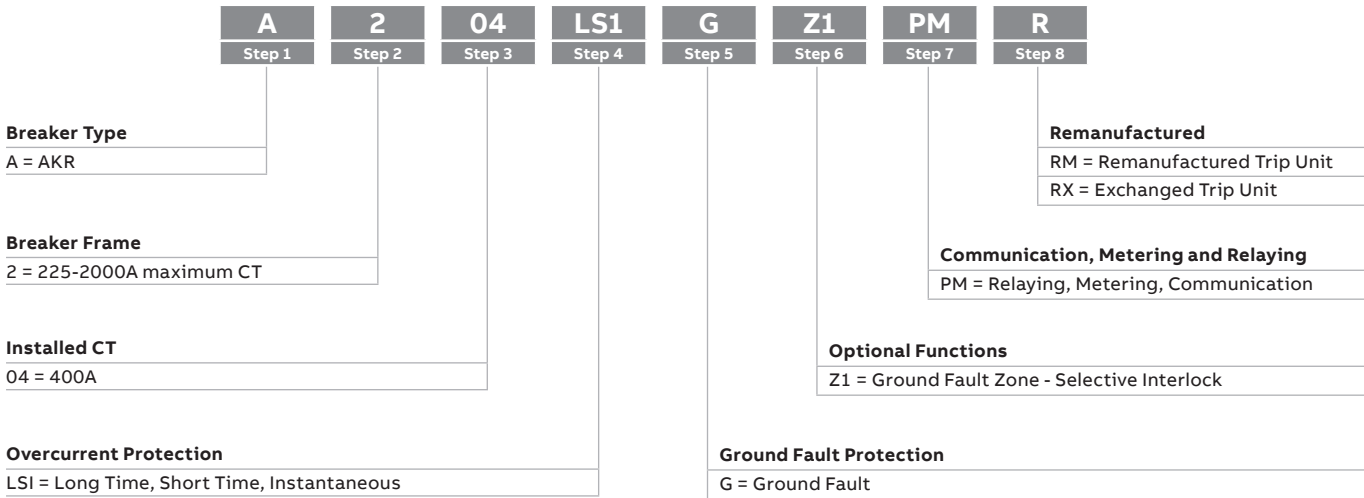

MVT PLUS/PM - AKR

Step 1 Breaker Type

Breaker Type	Code
Power Break	C

Step 2 Breaker Frame

Breaker Frame (max CT)	Code
225-2000A	2
3200A	3
4000A	4

Step 3 Installed CT

Installed CT	Code
150A	01
225A	03
400A	04
600A	06
800A	08
1600A	16
2000A	20
3000A	30
3200A	32
4000A	40

Step 4 Overcurrent Protection

Overcurrent Protection	Code
Long-Time (standard)	L
Short-Time	S
High Instantaneous	H
Instantaneous	I
Fixed High Instantaneous	K

Step 5 Ground Fault Protection

Ground Fault Protection	Code
Ground Fault	G
Defeatable ground fault (not UL Listed)	GD
W Curve	W

Step 6 Optional Functions

Optional Functions	Code
Ground-Fault zone - selective interlock	Z1
Ground-Fault and short-time ZSI	Z2
Switchable instantaneous short time and ground fault	X

Step 7 Communication, Metering and Relaying

Communication, Metering and Relaying	Code
Relaying and Communication	P
Metering and Communication	M

Step 8 Remanufactured

Remanufactured	Code
Remanufactured trip unit	RM
Exchanged trip unit	RX

Trip unit conversion kits

ABB offers a complete line of trip unit upgrade kits for low voltage power circuit breakers manufactured by ABB, as well as by Westinghouse, I-T-E, and Allis-Chalmers. These conversion kits contain everything necessary to convert an old-style electromechanical or solid-state trip unit to today's latest electronic, digital technology—including the addition of metering, protective relay, waveform capture, RELT, and communication functions. All conversion kits designed by ABB are tested to ANSI C37.59 standards for each breaker type so customers have the assurance of safe, reliable operation.

Features and Benefits—All Kits

- Kit includes everything needed in one compact package
- Full-range of interchangeable rating plugs
- Trip targets for quick identification of overload, short circuit, and ground fault trips
- Sealable, see-through cover to prevent unauthorized access to trip unit settings
- Portable Trip Unit Test Kits; GTUTK20 and TVRMS2
- Eliminate costly downtime due to nuisance tripping
- Improved power system coordination and protection
- Extend life and function of existing breakers and low voltage equipment

EntelliGuard™ TU Conversion Kits

- True RMS sensing with a sampling rate of 48 samples per cycle with the ability to Waveform capture 4 cycles prior and 4 cycles after an event
- Long Time, Short Time, and Instantaneous Standard on all trip units. S and I switchable on ANSI breakers
- Large backlit LCD screen, view all currents on one screen
- Trip settings and trip target information stored in non-volatile memory
- On-board lithium battery (field replaceable) for cold set-up and reading trip targets
- Status and Event Log, view the last 10 events
- Health Status LED and Thermal Memory
- Comm port for interface with set-up software and to download Waveform
- Optional metering, relaying, communications, ZSI - I, ground fault (trip & alarm), and fused shaped curves
- Plug and Play with previous generation of RMS9, EPIC, MVT and Enhanced MVT Trip Units

ProTrip™ Conversion Kits

- Cost-effective upgrade with standard adjustable long time, short time, instantaneous, and defeatable ground fault functions
- Simple-to-use rotary switches for selecting the trip unit pickup and delay settings
- True RMS sensing with sampling rate of 48 times per cycle per phase - accurate waveform measurements through the 11th harmonic
- Standard target module with individual LEDs for overload pickup, overload trip, short circuit trip, ground fault trip, and target module battery monitor

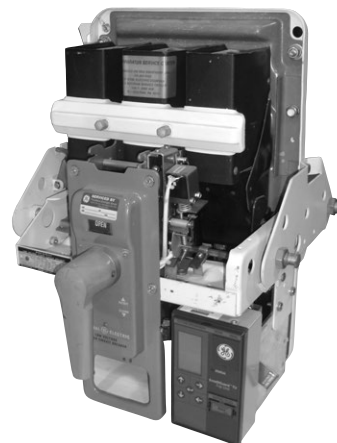

AK-25 Breaker with EntelliGuard™ TU Trip Unit



EntelliGuard TU Conversion Kits

Everything You Need in One Package

ProTrip™ and EntelliGuard™ TU conversion kits for the breakers listed in the following pages are shipped complete with detailed installation instructions and everything needed for fast and easy trip unit conversions.

- Digital solid-state trip with quick disconnect
- Direct-acting flux shift trip actuator with automatic reset
- Epoxy encapsulated high-accuracy current sensors
- Interchangeable rating plug (order separately)
- Specially designed mounting hardware and wire harnesses for each breaker frame

Trip unit conversion kits for legacy circuit breakers

EntelliGuard™ TU Conversion Kits—Upgrade your low-voltage equipment with electronic trip unit technology.

Normal wear and tear of aging electro-mechanical trip devices on low-voltage circuit breakers increases susceptibility to loss of calibration that can subsequently jeopardize electrical power system coordination, protection and reliability.

ABB has channeled its decades of circuit breaker trip system experience into the development of the EntelliGuard™ TU Trip Unit. The EntelliGuard™ TU builds on the past trip units by incorporating advance algorithms that enable Arc Flash protection and Selectivity at the same time.

ANSI C37.59 design verification tested to ensure safe, reliable operation, these kits are designed to extend the life of your mechanically sound breaker and...

- Eliminate costly downtime due to nuisance tripping. Improves on past trip units with a Waveform Recognition Instantaneous Algorithm
- Improve electrical power system coordination and protection
- Permit easy upgrades to communicating Power Management Control Systems (PMCS), open Modbus RTU protocol
- Enable the implementation of RELT and Zone Selective Interlock Instantaneous to reduce Arc Flash Energy Levels.

Standard Features

- Flexible Time Current Settings
- I²T Long Time, Long Time Delay
- Short Time, Short Time Delay, 3 Short Time I²T Slopes
- Waveform Recognition Instantaneous
- Ammeter
- Large Backlit LCD Screen¹
- Date and Time¹
- Breaker Status Indication
- Universal Rating Plugs
- Status and Event Log (10 Events)
- LED Health Status Indicator¹
- Set-up Software
- I/O – 1 Input and 1 Output¹
- Thermal Memory, Battery Back-up
- Common Interface across all versions

Optional

- Internal/External Ground Fault Trip or Alarm with 4 curves to select from (I²T, I⁴T, SGF, Definite Time Slope)¹
- Switchable Ground Fault Trip / Alarm (not UL Listed)
- Fused Long Time Curves (I⁴T)
- Modbus Open RTU Communications¹
- Waveform Capture – Enables Harmonic analysis
- Full-function Metering¹
- Protective Relaying¹
- Zone Selective Interlock – GF, S, I¹
- RELT – Reduce Energy Let Through¹
- RELT and Ground Fault Alarm Harness Kits
- Test Set GTUTK20



EntelliGuard™ TU Trip Unit

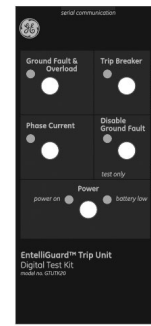

Test Kit – GTUTK20

Arc Flash and Selectivity at the same time

The EntelliGuard™ TU Trip Unit offers optimum circuit protection and optimum system reliability simultaneously with little or no compromise to either of these critical functions. Reliability and arc flash protection, in one package, at the same time, all the time.

Algorithms enabling arc flash protection and selectivity

- RELT – Reduced Energy Let Through
- Instantaneous Zone Selective Interlocking – (I-ZSI)
- Waveform Recognition Instantaneous – Coordinate with Current Limiting Devices and reduces Nuisance Trips
- Flexible Time Current Curves – Create the shape you need

Reliability – Health Status

- Non-volatile memory with continuous self-testing microprocessor
- Health Status LED indicates Normal Operation, Errors, Pick-up, Trip
- External Power Not Required with Long Life Lithium Battery
- Positive setpoint recognition, values flash until saved

Plug and Play

- Same Form, Fit, Function as the popular MicroVersaTrip™ Trip Unit. Easily upgrade an existing converted breaker¹

Optional Full-function metering including¹

- current (Amps, kAmps)
- voltage (Ph-Ph, Ph-N)
- energy (kWh, MWh, GWh)
- real power (kW, MW)
- total power (kVA, MVA)
- frequency (Hz)
- demand (avg. kW, MW) and peak demand

Optional protective relaying functions include¹

- undervoltage
- overvoltage
- voltage unbalance
- current unbalance
- power reversal
- power direction setup

¹Note: Some options require 24Vdc, additional hardware to enable Metering, Relaying, RELT, ZSI, Modbus to be added to the Breaker, Equipment Cubicle, and Equipment Sections.

Trip unit conversion kits for I-T-E, Westinghouse, Allis-Chalmers circuit breakers

MicroVersaTrip™ PM Conversion Kits— Power Management Made Easy

The MicroVersaTrip™ PM trip unit's standard communication port opens a new world of information. When connected to a ABB Power Management system, it gives you the power to increase productivity and reduce costs, while meeting all your electrical system monitoring needs.

The POWER LEADER™ Modbus Concentrator can be connected to MicroVersaTrip™ PM trip units, allowing communication with the ABB Power Management Control System (PMCS) software. With PMCS, you'll see how easy it is to:

- View custom metering screens and CAD drawings of our system
- Analyze energy consumption and power factor trends to minimize utility demand and PF charges or provide cost allocations
- Collect precise sequence of event and alarm information to speed diagnosis and minimize downtime
- Utilize alarm and event logs to assist with maintenance interval planning
- Analyze system harmonics (with data from the POWER LEADER™ family of meters)
- Use the POWER LEADER™ Modbus Concentrator to communicate with MicroVersaTrip™ PM trip units on Spectra Series molded case circuit breakers, Power Break II insulated case circuit breakers, and AKR power circuit breakers (refer to BuyLog™ Section 22 for network architecture)
- Communicate with Modbus RTU-supported electronic meters and relays

Additional Features

- Full-function metering including
 - current (Amps, kAmps)
 - voltage (Ph-Ph, Ph-N)
 - energy (kWh, MWh, GWh)
 - real power (kW, MW)
 - total power (kVA, MVA)
 - frequency (Hz)
 - demand (avg. kW, MW) and peak demand

Optional protective relaying functions include

- undervoltage
- overvoltage
- voltage unbalance
- current unbalance
- power reversal
- power direction setup

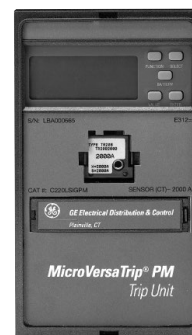

Refer to BuyLog™ Section 2 for additional Power Management components not supplied with the MicroVersaTrip™ PM conversion kits (voltage transformers, voltage conditioners, 24 Vdc power supplies, Modbus Concentrator, interconnection cables, and PMCS software)

Reference Publications

ABB MVT Plus and PM Conversion Kits	DET-066
ITE MVT Plus and PM Conversion Kits	DET-067
Westinghouse MVT Plus and PM Conversion Kits	DET-093
Allis-Chalmers MVT Plus and PM Conversion Kits	DET-226
ABB ProTrip™ Conversion Kits	DET-228
ITE ProTrip™ Conversion Kits	DET-229
Westinghouse ProTrip™ Conversion Kits	DET-230
Allis-Chalmers ProTrip™ Conversion Kits	DET-231

NOTE: MICROVERSATRIP™ TRIP UNITS IN LEGACY STATUS WILL BE OBSOLETE WHEN INVENTORY IS DEPLETED.

ProTrip™ trip unit conversion kit selection guide

For ABB circuit breakers

Product Number Structure

PK115 **D** **3** **F** **01** **08**

Breaker Type

AK-1-15	PK115
AK-15	PKO15 ¹
AK-1-25	PK125
AK-25	PKO75 ³
AKU-25	
AK-1-50	PKO50 ¹
AK-50	
AKU-50 ²	
AKT-50	PK150
AKS-50	
AKSU-50 ²	
AKST-50	
AK-75 ³	PKO75 ³
AK-100 ³	PKO10 ³

Model

Generation-D

Wiring

3 Wire-3
4 Wire-4

Sensor Type

Fixed CTs-F

Trip Functions

LSIGX-08

Trip Unit Functions

LSIGX- Long Time, Short Time/INST.
and Switchable Ground Fault (off)

Not Approved for a UL Listed Breaker

Sensor Rating

150A-	01
225A-	02
600A-	06
800A-	08
1600A-	16
2000A-	20
3000A-	30
4000A-	40

Sensor Rating Selection

Frame	Breaker Product Number	Sensors
225	AK-1-15, AK-15	150A, 225A
600	AK-1-25, AK-25, AKU-25	150A, 225A, 600A
1600	AK-1-50, AK-50, AKU-50, AKS-50, AKSU-50	800A, 1600A
2000	AKT-50, AKST-50	2000A
3000	AK-75	3000A
4000	AK-100	4000A

¹For converting AK-2 version breakers and newer, not applicable for AK-1 or AKR

²Breakers equipped with older style open fuse lockout devices (OFLO), must be retrofitted with newer style OFLO device prior to conversion process.

Order replacement OFLO kits as follows: AKU-50 - order OFLO kit #121C287OG2, AK-75 - order OFLO kit #121C287OG3, AK-100 - order OFLO kit #121C287OG4

³Contact the factory for stationary breaker applications

ProTrip™ Conversion Kits

Frame Size (Amps)	Breaker Model	Wiring	Sensor Rating	Product Number
225	AK-1-15	3 Wire	150A	PK115D3F0108
225	AK-1-15	3 Wire	225A	PK115D3F0208
225	AK-1-15	4 Wire	150A	PK115D4F0108
225	AK-1-15	4 Wire	225A	PK115D4F0208
225	AK-15	3 Wire	150A	PKO15D3F0108
225	AK-15	3 Wire	225A	PKO15D3F0208
225	AK-15	4 Wire	150A	PKO15D4F0108
225	AK-15	4 Wire	225A	PKO15D4F0208
600	AK-1-25	3 Wire	150A	PK125D3F0108
600	AK-1-25	3 Wire	225A	PK125D3F0208
600	AK-1-25	3 Wire	600A	PK125D3F0608
600	AK-1-25	4 Wire	150A	PK125D4F0108
600	AK-1-25	4 Wire	225A	PK125D4F0208
600	AK-1-25	4 Wire	600A	PK125D4F0608
600	AK-25, AKU-25	3 Wire	150A	PKO25D3F0108
600	AK-25, AKU-25	3 Wire	225A	PKO25D3F0208
600	AK-25, AKU-25	3 Wire	600A	PKO25D3F0608
600	AK-25, AKU-25	4 Wire	150A	PKO25D4F0108
600	AK-25, AKU-25	4 Wire	225A	PKO25D4F0208
600	AK-25, AKU-25	4 Wire	600A	PKO25D4F0608
1600	AK-1-50	3 Wire	800A	PK150D3F0808
1600	AK-1-50	3 Wire	1600A	PK150D3F1608
1600	AK-1-50	4 Wire	800A	PK150D4F0808
1600	AK-1-50	4 Wire	1600A	PK150D4F1608
1600	AK-50, AKU-50, AKT-50, AKS-50, AKSU-50, AKST-50	3 Wire	800A	PKO50D3F0808
1600	AK-50, AKU-50, AKT-50, AKS-50, AKSU-50, AKST-50	3 Wire	1600A	PKO50D3F1608
1600	AK-50, AKU-50, AKT-50, AKS-50, AKSU-50, AKST-50	3 Wire	2000A	PKO50D3F2008
1600	AK-50, AKU-50, AKT-50, AKS-50, AKSU-50, AKST-50	4 Wire	800A	PKO50D4F0808
1600	AK-50, AKU-50, AKT-50, AKS-50, AKSU-50, AKST-50	4 Wire	1600A	PKO50D4F1608
1600	AK-50, AKU-50, AKT-50, AKS-50, AKSU-50, AKST-50	4 Wire	2000A	PKO50D4F2008
3000	AK-75	3 Wire	3000A	PKO75D3F3008
3000	AK-75	4 Wire	3000A	PKO75D4F3008
4000	AK-100	3 Wire	4000A	PKO10D3F4008
4000	AK-100	4 Wire	4000A	PKO10D4F4008

Conversion kits come standard with a rating plug that matches the current sensor. For rating plugs with different values, order separately. See page 8-133.

ProTrip™ trip unit conversion kit selection guide

For *I-T-E circuit breakers

Product Number Structure

PIK22 **D** **3** **F** **02** **08**

Breaker Type

K225	PIK22¹
K600 KDON600	PIK60¹
K800 KDON800	PIK80¹
K1600 (black) KDON1600 (black)	PIK1B¹
K1600 (red) KDON1600 (red)	PIK16^{1,2} PIKN^{1,3}

Model

Generation-D

Wiring

3 Wire-3

4 Wire-4

Sensor Type

Fixed CTs-F

Trip Functions

LSIGX-08

Trip Unit Functions

LSIGX- Long Time, Short Time/INST.

and Switchable Ground Fault (off)

Not Approved for a UL Listed Breaker

Sensor Rating

150A-	01
225A-	02
400A-	04
600A-	06
800A-	08
1600A-	16

Sensor Rating Selection

Frame	Breaker Product Number	Sensors
225	K225	150A, 225A
600	K600, KDON600	150A, 225A, 600A
800	K800, KDON800	150A, 400A, 800A
1600	K1600 (black), KDON1600 (black), K1600 (red), KDON1600 (red)	800A, 1600A

¹For converting AK-2 version breakers and newer, not applicable for AK-1 or AKR

²Breakers equipped with older style open fuse lockout devices (OFLO), must be retrofitted with newer style OFLO device prior to conversion process.

Order replacement OFLO kits as follows: AKU-50 - order OFLO kit #121C287OG2, AK-75 - order OFLO kit #121C287OG3, AK-100 - order OFLO kit #121C287OG4

³Contact the factory for stationary breaker applications

ProTrip™ Conversion Kits

Frame Size (Amps)	Breaker Model	Wiring	Sensor Rating	Product Number
225	K225	3 Wire	150A	PIK22D3F0108
225	K225	3 Wire	225A	PIK22D3F0208
225	K225	4 Wire	150A	PIK22D4F0108
225	K225	4 Wire	225A	PIK22D4F0208
600	K600, KDON600	3 Wire	150A	PIK60D3F0108
600	K600, KDON600	3 Wire	225A	PIK60D3F0208
600	K600, KDON600	3 Wire	600A	PIK60D3F0608
600	K600, KDON600	4 Wire	150A	PIK60D4F0108
600	K600, KDON600	4 Wire	225A	PIK60D4F0208
600	K600, KDON600	4 Wire	600A	PIK60D4F0608
800	K800, KDON800	3 Wire	150A	PIK80D3F0108
800	K800, KDON800	3 Wire	400A	PIK80D3F0408
800	K800, KDON800	3 Wire	800A	PIK80D3F0808
800	K800, KDON800	4 Wire	150A	PIK80D4F0108
800	K800, KDON800	4 Wire	400A	PIK80D4F0408
800	K800, KDON800	4 Wire	800A	PIK80D4F0808
1600	K1600 (black), KDON1600 (black)	3 Wire	800A	PIK1BD3F0808
1600	K1600 (black), KDON1600 (black)	3 Wire	1600A	PIK1BD3F1608
1600	K1600 (black), KDON1600 (black)	4 Wire	800A	PIK1BD4F0808
1600	K1600 (black), KDON1600 (black)	4 Wire	1600A	PIK1BD4F1608
1600	K1600 (red)	3 Wire	800A	PIK16D3F0808
1600	K1600 (red)	3 Wire	1600A	PIK16D3F1608
1600	K1600 (red)	4 Wire	800A	PIK16D4F0808
1600	K1600 (red)	4 Wire	1600A	PIK16D4F1608
1600	KDON1600 (red)	3 Wire	800A	PIKN1D3F0808
1600	KDON1600 (red)	3 Wire	1600A	PIKN1D3F1608
1600	KDON1600 (red)	4 Wire	800A	PIKN1D4F0808
1600	KDON1600 (red)	4 Wire	1600A	PIKN1D4F1608

Conversion kits come standard with a rating plug that matches the current sensor. For rating plugs with different values, order separately. See page 8-133.

*I-T-E is a registered trademark of Siemens Energy and Automation, Inc.

ProTrip™ trip unit conversion kit selection guide

For *Allis-Chalmers circuit breakers

Product Number Structure

PSL6B | **D** | **3** | **F** | **02** | **08**

Breaker Type

LA-600 (blue) LAF-600 (blue)	PSL6B
LA-600 (gold) LAF-600 (gold)	PSL6G
LA-800 (gold) LAF-800 (gold)	PSL80
LA-1600 (blue) LAF-1600 (blue)	PSL1B
LA-1600 (gold) LAF-1600 (gold)	PSL1G

Model

Generation-D

Wiring

3 Wire-3
4 Wire-4

Sensor Type

Fixed CTs-F

Trip Functions

LSIGX-08

Trip Unit Functions

LSIGX- Long Time, Short Time/INST.
and Switchable Ground Fault (off)
Not Approved for a UL Listed Breaker

Sensor Rating

150A- **01**
225A- **02**
400A- **04**
600A- **06**
800A- **08**
1600A- **16**

Sensor Rating Selection

Frame	Breaker Product Number	Sensors
600	LA-600 (blue), LAF-600 (blue), LA-600 (gold), LAF-600 (gold)	150A, 225A, 600A
800	LA-800 (gold), LAF-800 (gold)	150A, 400A, 800A
1600	LA-1600 (blue), LAF-1600 (blue), LA-1600 (gold), LAF-1600 (gold)	800A, 1600A

ProTrip™ Conversion Kits

Frame Size (Amps)	Breaker Model	Wiring	Sensor Rating	Product Number
600	LA-600 (blue), LAF-600 (blue)	3 Wire	150A	PSL6BD3F0108
600	LA-600 (blue), LAF-600 (blue)	3 Wire	225A	PSL6BD3F0208
600	LA-600 (blue), LAF-600 (blue)	3 Wire	600A	PSL6BD3F0608
600	LA-600 (blue), LAF-600 (blue)	4 Wire	150A	PSL6BD4F0108
600	LA-600 (blue), LAF-600 (blue)	4 Wire	225A	PSL6BD4F0208
600	LA-600 (blue), LAF-600 (blue)	4 Wire	600A	PSL6BD4F0608
600	LA-600 (gold), LAF-600 (gold)	3 Wire	150A	PSL6GD3F0108
600	LA-600 (gold), LAF-600 (gold)	3 Wire	225A	PSL6GD3F0208
600	LA-600 (gold), LAF-600 (gold)	3 Wire	600A	PSL6GD3F0608
600	LA-600 (gold), LAF-600 (gold)	4 Wire	150A	PSL6GD4F0108
600	LA-600 (gold), LAF-600 (gold)	4 Wire	225A	PSL6GD4F0208
600	LA-600 (gold), LAF-600 (gold)	4 Wire	600A	PSL6GD4F0608
800	LA-800 (gold)	3 Wire	150A	PSL80D3F0108
800	LA-800 (gold)	3 Wire	400A	PSL80D3F0408
800	LA-800 (gold)	3 Wire	800A	PSL80D3F0808
800	LA-800 (gold)	4 Wire	150A	PSL80D4F0108
800	LA-800 (gold)	4 Wire	400A	PSL80D4F0408
800	LA-800 (gold)	4 Wire	800A	PSL80D4F0808
1600	LA-1600 (blue), LAF-1600 (blue)	3 Wire	800A	PSL1BD3F0808
1600	LA-1600 (blue), LAF-1600 (blue)	3 Wire	1600A	PSL1BD3F1608
1600	LA-1600 (blue), LAF-1600 (blue)	4 Wire	800A	PSL1BD4F0808
1600	LA-1600 (blue), LAF-1600 (blue)	4 Wire	1600A	PSL1BD4F1608
1600	LA-1600 (gold), LAF-1600 (gold)	3 Wire	800A	PSL1GD3F0808
1600	LA-1600 (gold), LAF-1600 (gold)	3 Wire	1600A	PSL1GD3F1608
1600	LA-1600 (gold), LAF-1600 (gold)	4 Wire	800A	PSL1GD4F0808
1600	LA-1600 (gold), LAF-1600 (gold)	4 Wire	1600A	PSL1GD4F1608

Conversion kits come standard with a rating plug that matches the current sensor. For rating plugs with different values, order separately. See page 8-133.

*Allis-Chalmers is a trademark of Allis-Chalmers Manufacturing Company Corporation.

ProTrip™ trip unit conversion kit selection guide

For *Westinghouse circuit breakers

Product Number Structure

		PDB15	D	3	F	02	08	
Breaker Type								Trip Functions
DB15, DBL15-	PDB15							LSIGX- 08
DB25, DBL25-	PDB25							Trip Unit Functions
DB50, DBL50-	PDB50							LSIGX- Long Time, Short Time/INST.
DB75-	PDB75							and Switchable Ground Fault (off)
DB100-	PDB10							Not Approved for a UL Listed Breaker
Model								Sensor Rating
Generation-D								150A- 01
								225A- 02
								600A- 06
								800A- 08
								1600A- 16
								3000A- 30
								4000A- 40
Wiring								Sensor Rating Selection
3 Wire-3								Frame Breaker Product Number Sensors
4 Wire-4								225 DB15, DBL15 150A, 225A
								600 DB25, DBL25 225A, 600A
								1600 DB50, DBL50 800A, 1600A
								3000 DB75 3000A
								4000 DB100 4000A
Sensor Type								
Fixed CTs-F								

ProTrip™ Conversion Kits

Frame Size (Amps)	Breaker Model	Wiring	Sensor Rating	Product Number
225	DB15, DBL15	3 Wire	150A	PDB15D3F0108
225	DB15, DBL15	3 Wire	225A	PDB15D3F0208
225	DB15, DBL15	4 Wire	150A	PDB15D4F0108
225	DB15, DBL15	4 Wire	225A	PDB15D4F0208
600	DB25, DBL25	3 Wire	150A	PDB25D3F0108
600	DB25, DBL25	3 Wire	225A	PDB25D3F0208
600	DB25, DBL25	3 Wire	600A	PDB25D3F0608
600	DB25, DBL25	4 Wire	150A	PDB25D4F0108
600	DB25, DBL25	4 Wire	225A	PDB25D4F0208
600	DB25, DBL25	4 Wire	600A	PDB25D4F0608
1600	DB50, DBL50	3 Wire	800A	PDB50D3F0808
1600	DB50, DBL50	3 Wire	1600A	PDB50D3F1608
1600	DB50, DBL50	4 Wire	800A	PDB50D4F0808
1600	DB50, DBL50	4 Wire	1600A	PDB50D4F1608
3000	DB75	3 Wire	3000A	PDB75D3F3008
3000	DB75	4 Wire	3000A	PDB75D4F3008
4000	DB100	3 Wire	4000A	PDB10D3F4008
4000	DB100	4 Wire	4000A	PDB10D4F4008

Conversion kits come standard with a rating plug that matches the current sensor. For rating plugs with different values, order separately. See page 8-133.

*Westinghouse is a trademark of Westinghouse Electric Corporation.

ProTrip™ rating plugs

ProTrip™ conversion kits come standard with a rating plug that matches the current sensor. For rating plugs with different values, price and order separately.

Reference Publications

ProTrip™ Trip Unit Conversion Kits for ABB Power Circuit Breakers - Fact Sheet	DET-228
ProTrip™ Trip Unit Conversion Kits for *Westinghouse Power Circuit Breakers - Fact Sheet	DET-230
ProTrip™ Trip Unit Conversion Kits for *Allis-Chalmers Power Circuit Breakers - Fact Sheet	DET-231
ProTrip™ Trip Unit Conversion Kits for *I-T-E Power Circuit Breakers - Fact Sheet	DET-229

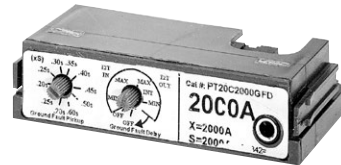

Rating Plug

Rating Plugs

Frame Size (Amps)	Sensor Rating (Amps)	Current Rating (Amps)	Current Range (Amps)	Product Number
225 600 800	150	80	40-88	PT1C80GFD
225 600 800	150	100	50-110	PT1C100GFD
225 600 800	150	125	63-138	PT1C125GFD
225 600 800	150	150	75-165	PT1C150GFD ¹
225 600 800	225	150	75-165	PT225C150GFD
225 600 800	225	225	113-248	PT225C225GFD ¹
600	600	300	150-330	PT6C300GFD
600	600	400	200-440	PT6C400GFD
600	600	450	225-495	PT6C450GFD
600	600	500	250-550	PT6C500GFD
600	600	600	300-660	PT6C600GFD ¹
800	400	200	100-220	PT4C200GFD
800	400	225	113-248	PT4C225GFD
800	400	250	125-275	PT4C250GFD
800	400	300	150-330	PT4C300GFD
800	400	400	200-440	PT4C400GFD ¹
800 1600	800	400	200-440	PT8C400GFD
800 1600	800	450	225-495	PT8C450GFD
800 1600	800	500	250-550	PT8C500GFD
800 1600	800	600	300-660	PT8C600GFD
800 1600	800	700	350-770	PT8C700GFD
800 1600	800	800	400-880	PT8C800GFD ¹
1600	1600	800	400-880	PT16C800GFD
1600	1600	1000	500-1100	PT16C1000GFD
1600	1600	1100	550-1210	PT16C1100GFD
1600	1600	1200	600-1320	PT16C1200GFD
1600	1600	1600	800-1760	PT16C1600GFD
2000	2000	1000	500-1100	PT20C1000GFD
2000	2000	1200	600-1320	PT20C1200GFD
2000	2000	1500	750-1650	PT20C1500GFD
2000	2000	1600	800-1760	PT20C1600GFD
2000	2000	2000	1000-2200	PT20C2000GFD
3000	3000	1200	600-1320	PT30C1200GFD
3000	3000	1600	800-1760	PT30C1600GFD
3000	3000	2000	1000-2200	PT30C2000GFD
3000	3000	2500	1250-2750	PT30C2500GFD
3000	3000	3000	1500-3300	PT30C3000GFD ¹
4000	4000	1600	800-1760	PT40C1600GFD
4000	4000	2000	1000-2200	PT40C2000GFD
4000	4000	2500	1250-2750	PT40C2500GFD
4000	4000	3000	1500-3300	PT40C3000GFD
4000	4000	3600	1800-3960	PT40C3600GFD
4000	4000	4000	2000-4000	PT40C4000GFD ¹

¹Rating Plug furnished with conversion kit.

Note: Long Time pickup range is 0.5-1.1 times the rating plug value. 1.1 setting allows the breaker to carry 100% of the rating plug current value, not to exceed the continuous current (frame) rating of the breaker. continuous current (frame) rating of the breaker.

*I-T-E is a registered trademark of Siemens Energy and Automation, Inc.

*Westinghouse is a trademark of Westinghouse Electric Corporation.

*Allis-Chalmers is a trademark of Allis-Chalmers Manufacturing Company Corporation.

EntelliGuard™ TU trip unit

Conversion kits selection guide

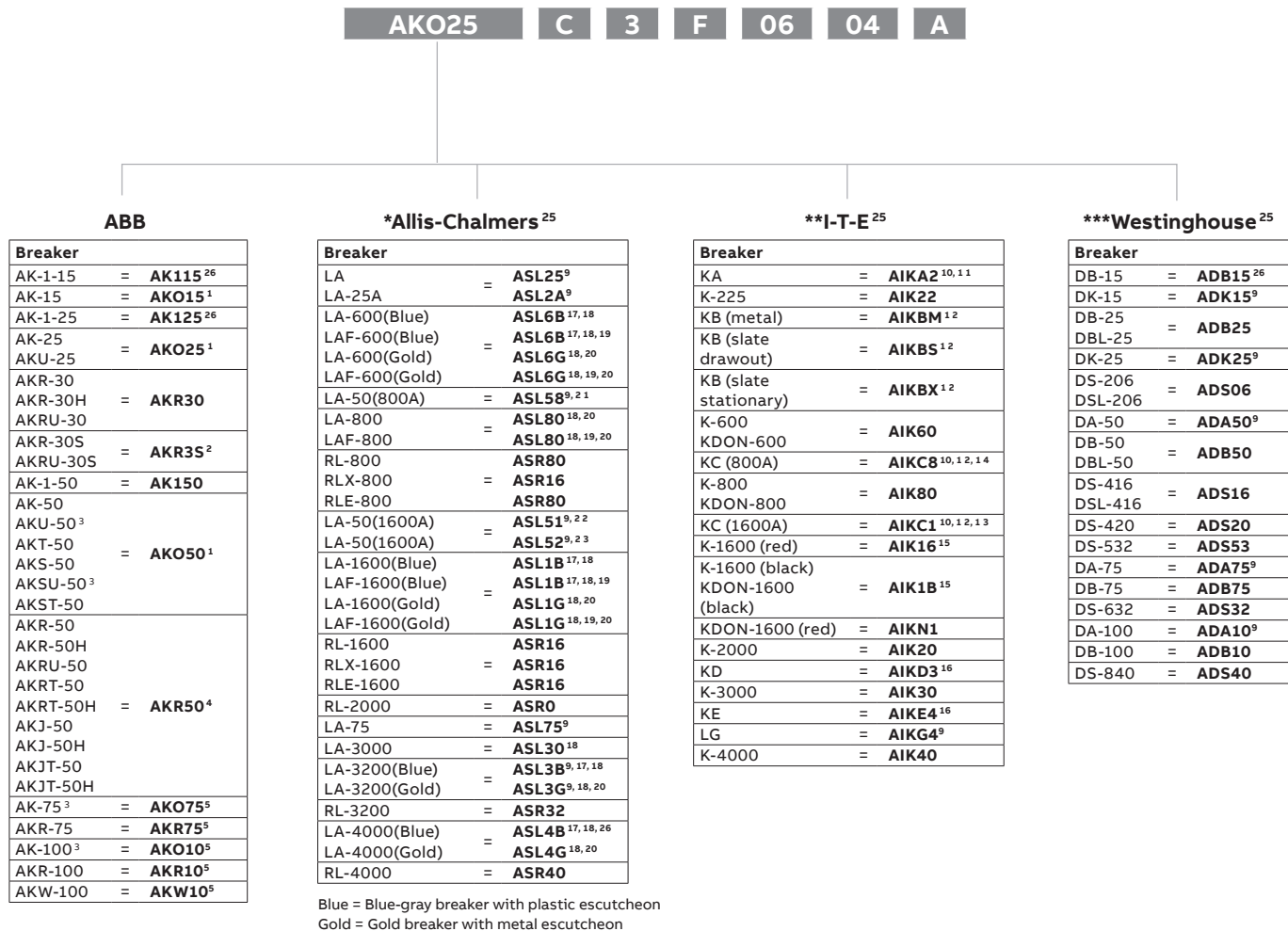

Sensor Rating Selection

Frame	Sensors	Breaker Catalog Numbers			
		ABB	*Allis-Chalmers	**I-T-E	***Westinghouse
225	150	AK-1-15, AK-15	Sensor rating not available.	KA, KA-225	DB-15, DK-15
	225				
600	150	AK-1-25, AK-25, AKU-25	LA-25, LA-25A, LA-600, LAF-600	KB, K-600, KDON-600	DB-25, DBL-25, DK-25
	225				
	600				
800	150	AKR-30, AKR-30H, AKRU-30, AKR-30S, AKRU-30S	LA-50 (800A Version), LA-800, LAF-800, RL-800, RLE-800, RLX-800	KC (800A Version), K-800, KDON-800	DS-206, DSL-206
	400				
	800				
1600	800	AKT-50, AKST-50, AKRT-50, AKRT-50H, AKJT-50, AKJT-50H	LA-50 (1600A Version), LA-1600, LAF-1600, RL-1600, RLE-1600, RLX-1600	KC (1600A Version), K-1600, KDON-1600	DA-50, DB-50, DBL-50, DS-416, DSL-416
	1600				
2000	2000	AKT-50, AKST-50, AKRT-50, AKRT-50H, AKJT-50, AKJT-50H	RL-2000	K-2000	DS-420
3000	3000	AK-75	LA-75, LA-3000	KD, K-3000	DA-75, DB-75
3200	3200	AKR-75	LA-3200, RL-3200	—	DS-632
4000	4000	AK-100, AKR-100, AKW-100	LA-4000, RL-4000	KE, LG, K-4000	DA-100, DB-100, DS-840

*Allis-Chalmers is a trademark of Allis-Chalmers Manufacturing Company Corporation.

**I-T-E is a registered trademark of Siemens Energy and Automation, Inc.

***Westinghouse is a trademark of Westinghouse Electric Corporation.

EntelliGuard™ TU trip unit

Conversion kits selection guide (continued)

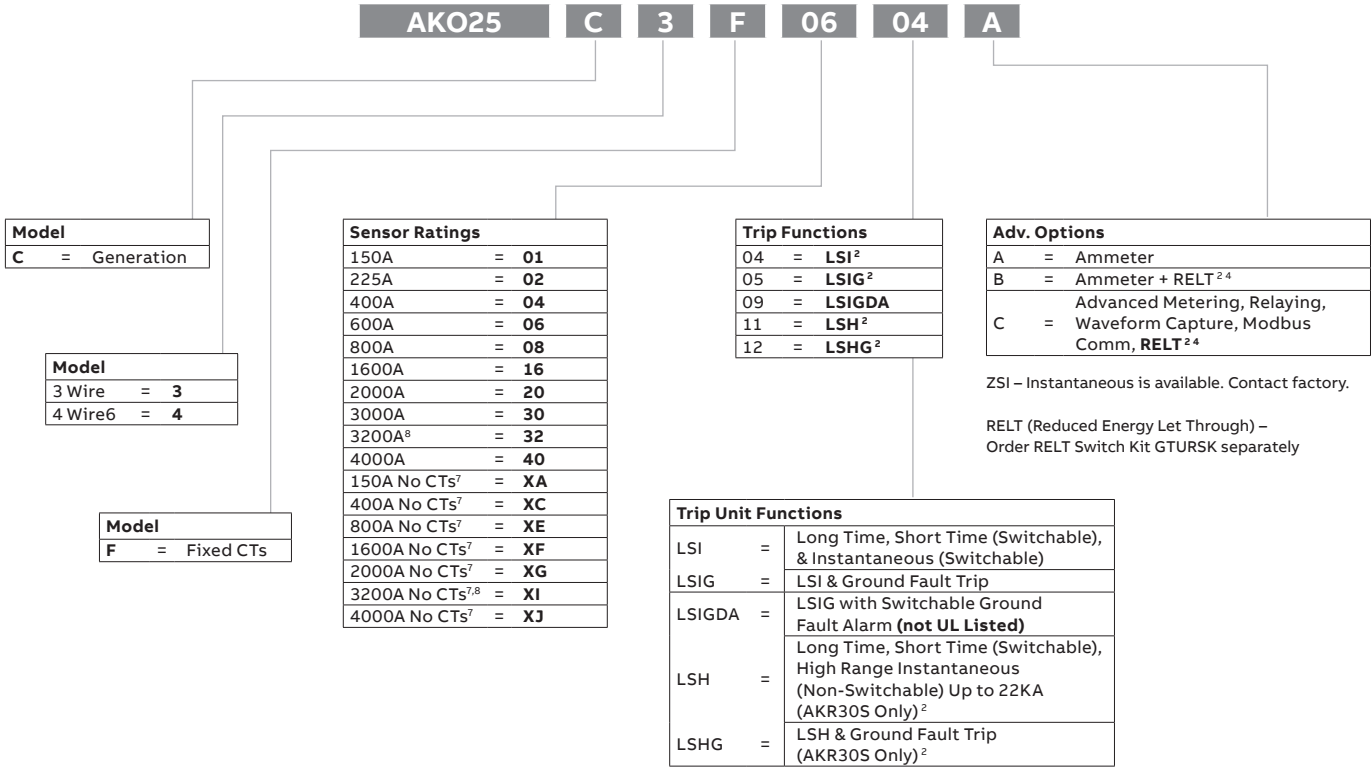

Reference Publications

EntelliGuard™ TU Conversion Kit Brochure	DET-722
EntelliGuard™ TU Conversion Kit Supplemental Instructions	DEH-3456
EntelliGuard™ TU Trip Unit Installation/Instruction Manual	DEH-4567
EntelliGuard™ TU Test Set - GTUTK20	DEH-4568A
ABB AK-1-15, AK-1-25	GEH-6466
ABB AK-1-50	DEH-40027
ABB AK-15, AK, AKU-25, AKR-30S, AKRU-30S	GEH-5967
ABB AKR-30,30H, AKRU-30, AKR-50, AKJ-50 Series	GEH-5966
ABB AK-100, AK,U,T,S,SU,ST-50, AK-75	GEH-5965
ABB AKR-100, AKR-75, AKW-100	GEH-5964
Westinghouse DB-15	GEH-6318
Westinghouse DB-25, DBL-25 (225A), DB-50, DBL-50	GEH-6319
Westinghouse DS-206, DSL-206, DS416, DSL-416, DS-420, DS-632	DEH-023
Westinghouse DB-100 (4000A), DB-75 (3000A)	GEH-6320
ITE K-1600 (red), K, KDON-1600 Black, K-2000, K-225, K-600, KDON-600, K-800, KDON-800, KDON-1600 (red)	GEH-6294
ITE KC (1600A), KC (800A)	GEH-6433
ITE KA	GEH-6293
ITE KB (Metal), KB (Slate Drawout), KB (Slate Fixed)	GEH-6295
ITE K-3000, K-4000	DEH-133
ITE KD-3000, KE-4000	DEH-40019
Allis Chalmers LA, LAF - 1600 (BLUE), LA, LAF-600 (BLUE)	DEH-40008
Allis Chalmers LA, LAF - 1600 (GOLD), LA, LAF-600 (GOLD), LA, LAF-800, RL, RLX, RLE-1600 & 800	DEH-40009A

¹For converting AK-2 version breakers and newer, not applicable for AK-1 or AKR.

²AKR30S Instantaneous Is Non-Switchable and the Non-Switchable High Range Instantaneous max is 22KA. LSH and LSHG Are Only Available on AKR30S.

³Breakers equipped with older style open fuse lockout devices (OFLO), must be retrofitted with newer style OFLO device prior to conversion process. Order replacement OFLO kits as follows: AKU-50 - order OFLO Kit #121C2870G2, AK-75 - order OFLO kit #121C2870G3, AK-100 - order OFLO kit #121C2870G4.

⁴Not applicable for converting breakers equipped with Power Sensor - contact factory.

⁵Contact the factory for stationary breaker applications.

⁶Only applicable to trip units with ground fault.

⁷Available only for MicroVersaTrip RMS-9 type AKR breakers equipped with fixed current sensors.

⁸Not available on AK-75 breaker frames.

⁹Contact factory for availability.

¹⁰Not applicable for slate version breakers.

¹¹Left pole accessories must be removed or relocated.

¹²Right pole accessories must be removed or relocated.

¹³1600-amp version of the KC breaker.

¹⁴800-amp version of the KC breaker.

¹⁵Order for red or black insulator as applicable.

¹⁶Not applicable to fixed mounted breakers.

¹⁷Only applicable for blue-gray color version breakers.

¹⁸Applicable to both "A" and "B" version breakers.

¹⁹Applicable to both nameplated versions of integral fused breakers (i.e., LA-600F and LAF-600).

²⁰Only applicable for gold color version breakers.

²¹800-amp version of the LA-50 breaker.

²²Only applicable for the 1600-amp, 6-pole primary disconnect version of the LA-50 breaker.

²³Only applicable for 1600-amp, 12 pole primary disconnect version of the LA-50 breaker.

²⁴Requires 24Vdc control power.

²⁵Existing Allis-Chalmers, I-T-E and Westinghouse bell alarms will not work with EntelliGuard TU.

²⁶Trip Unit will be mounted horizontally on breaker.

EntelliGuard™ TU trip unit

Conversion kits selection guide

EntelliGuard™ TU are determined by the Frame Rating, Breaker Model, 3 or 4 wire, Trip Functions, and Advanced Features.
 (Example: Items highlighted in bold **AKO25 C 3 F 06 04 A**)

For ABB Power Circuit Breakers

EntelliGuard™ TU Trip Unit Conversion Kits for 3-Phase, 3-Wire

Frame Amps	Breaker Model	LSI (04)			LSIG (05)			LSIGDA (09)		
		Ammeter (A)	Ammeter + RELT (B)	All Advanced Options (C)	Ammeter (A)	Ammeter + RELT (B)	All Advanced Options (C)	Ammeter (A)	Ammeter + RELT (B)	All Advanced Options (C)
225	AK115									
	AKO15									
600	AK125									
	AKO25									
800	AKR30									
	AKR35									
1600	AK150									
	AKO50									
2000	AKR50									
	AK150									
3000	AKO75									
3200	AKR75									
4000	AKO10									
	AKR10									
	AKW10									

For ABB Power Circuit Breakers

EntelliGuard™ TU Trip Unit Conversion Kits for 3-Phase, 4-Wire

Frame Amps	Breaker Model	LSI			LSIG (05)			LSIGDA (09)		
		Ammeter (A)	Ammeter + RELT (B)	All Advanced Options (C)	Ammeter (A)	Ammeter + RELT (B)	All Advanced Options (C)	Ammeter (A)	Ammeter + RELT (B)	All Advanced Options (C)
225	AK115									
	AKO15									
600	AK125									
	AKO25									
800	AKR30									
	AKR35									
1600	AK150									
	AKO50									
2000	AKR50									
	AK150									
3000	AKO75									
3200	AKR75									
4000	AKO10									
	AKR10									
	AKW10									

For *Allis-Chalmers Power Circuit Breakers

EntelliGuard™ TU Trip Unit Conversion Kits for 3-Phase, 3-Wire

Frame Amps	Breaker ¹ Model	LSI (04)			LSIG (05)			LSIGDA (09)		
		Ammeter (A)	Ammeter + RELT (B)	All Advanced Options (C)	Ammeter (A)	Ammeter + RELT (B)	All Advanced Options (C)	Ammeter (A)	Ammeter + RELT (B)	All Advanced Options (C)
600	ASL6B									
	ASL6G									
	ASL80									
800	ASR80									
	ASL1B									
1600	ASL1G									
	ASR16									
2000	ASR0									
3000	ASL30									
3200	ASR32									
4000	ASR40									
	ASL4G									
	ASL4B									

¹Contact factory for breaker models not listed.

*Allis-Chalmers is a trademark of Allis-Chalmers Manufacturing Company Corporation.

EntelliGuard™ TU trip unit

Conversion kits selection guide

For *Allis-Chalmers Power Circuit Breakers EntelliGuard™ TU Trip Unit Conversion Kits for 3-Phase, 4-Wire

Frame Amps	Breaker ¹ Model	LSI			LSIG (05)			LSIGDA (09)		
		Ammeter (A)	Ammeter + RELT (B)	All Advanced Options (C)	Ammeter (A)	Ammeter + RELT (B)	All Advanced Options (C)	Ammeter (A)	Ammeter + RELT (B)	All Advanced Options (C)
600	ASL6B									
	ASL6G									
800	ASL80									
	ASR80									
1600	ASL1B									
	ASL1G									
	ASR16									
2000	ASR0									
3000	ASL30									
3200	ASR32									
4000	ASR40									
	ASL4G									
	ASL4B									

For **I-T-E Power Circuit Breakers EntelliGuard™ TU Trip Unit Conversion Kits for 3-Phase, 3-Wire

Frame Amps	Breaker ¹ Model	LSI (04)			LSIG (05)			LSIGDA (09)		
		Ammeter (A)	Ammeter + RELT (B)	All Advanced Options (C)	Ammeter (A)	Ammeter + RELT (B)	All Advanced Options (C)	Ammeter (A)	Ammeter + RELT (B)	All Advanced Options (C)
225	AIKA2									
	AIK22									
600	AIKBM									
	AIKBS									
	AIKBX									
	AIK60									
800	AIKC8									
	AIK80									
1600	AIKC1									
	AIK16									
	AIK1B									
	AIKN1									
2000	AIK20									
3000	AIK30									
4000	AIK40									

For **I-T-E Power Circuit Breakers EntelliGuard™ TU Trip Unit Conversion Kits for 3-Phase, 4-Wire

Frame Amps	Breaker ¹ Model	LSI			LSIG (05)			LSIGDA (09)		
		Ammeter (A)	Ammeter + RELT (B)	All Advanced Options (C)	Ammeter (A)	Ammeter + RELT (B)	All Advanced Options (C)	Ammeter (A)	Ammeter + RELT (B)	All Advanced Options (C)
225	AIKA2									
	AIK22									
600	AIKBM									
	AIKBS									
	AIKBX									
	AIK60									
800	AIKC8									
	AIK80									
1600	AIKC1									
	AIK16									
	AIK1B									
	AIKN1									
2000	AIK20									
3000	AIK30									
4000	AIKE4									
	AIK40									

¹Contact factory for breaker models not listed.

*Allis-Chalmers is a trademark of Allis-Chalmers Manufacturing Company Corporation.

**I-T-E is a registered trademark of Siemens Energy and Automation, Inc.

EntelliGuard™ TU trip unit

Conversion kits selection guide

For *Westinghouse Power Circuit Breakers EntelliGuard™ TU Trip Unit Conversion Kits for 3-Phase, 3-Wire

Frame Amps	Breaker ¹ Model	LSI (04)			LSIG (05)			LSIGDA (09)		
		Ammeter (A)	Ammeter + RELT (B)	All Advanced Options (C)	Ammeter (A)	Ammeter + RELT (B)	All Advanced Options (C)	Ammeter (A)	Ammeter + RELT (B)	All Advanced Options (C)
225	ADB15									
600	ADB25									
800	ADS06									
1600	ADB50									
	ADS16									
2000	ADS20									
3000	ADB75									
3200	ADS32									
4000	ADB10									
	ADS40									

For *Westinghouse Power Circuit Breakers EntelliGuard™ TU Trip Unit Conversion Kits for 3-Phase, 4-Wire

Frame Amps	Breaker ¹ Model	LSI			LSIG (05)			LSIGDA (09)		
		Ammeter (A)	Ammeter + RELT (B)	All Advanced Options (C)	Ammeter (A)	Ammeter + RELT (B)	All Advanced Options (C)	Ammeter (A)	Ammeter + RELT (B)	All Advanced Options (C)
225	ADB15									
600	ADB25									
800	ADS06									
1600	ADB50									
	ADS16									
2000	ADS20									
3000	ADB75									
3200	ADS32									
4000	ADB10									
	ADS40									

¹Contact factory for breaker models not listed.

EntelliGuard™ TU Trip Rating Plug Specifications

Plug Rating	May Be Used With Trip Plug		Sensor Product Number
	Minimum Rating	Maximum Sensor	
60 A ²	150A ⁴	150A ⁴	GTP0060U0101
80A ²	150A ⁴	150A ⁵	GTP0080U0101
100A ³	150A ⁴	225A ⁵	GTP0100U0103
125A ²	150A ⁴	225A ⁵	GTP0125U0103
150A	150A ⁴	400A	GTP0150U0104
200A	200A ⁵	400A	GTP0200U0204
225A	225A	600A	GTP0225U0306
250A	400A	630A ¹	GTP0250U0407
300A	400A	800A	GTP0300U0408
350A	400A	800A	GTP0350U0408
400A	400A	1000A	GTP0400U0410
450A	600A	1200A	GTP0450U0612
500A	600A	1250A ¹	GTP0500U0613
600A	600A	1600A	GTP0600U0616
700A	800A	1600A	GTP0700U0816
750A	800A	2000A	GTP0750U0820
800A	800A	2000A	GTP0800U0820
900A	1000A	2000A	GTP0900U1020
1000A	1000A	2500A	GTP1000U1025
1100A	1200A	2500A	GTP1100U1225
1200A	1200A	3200A	GTP1200U1232
1500A	1600A	4000A	GTP1500U1640
1600A	1600A	4000A	GTP1600U1640
1900A	2000A	5000A	GTP1900U2050
2000A	2000A	5000A	GTP2000U2050
2200A	2500A	5000A	GTP2200U2550
2400A	2500A	6400A ⁶	GTP2400U2564
2500A	2500A	6400A ⁶	GTP2500U2564
3000A	3000A	6400A ⁶	GTP3000U3064
3200A	3200A	6400A ⁶	GTP3200U3264
3600A	4000A	6400A ⁶	GTP3600U4064
4000A	4000A	6400A ⁶	GTP4000U4040 ⁷
4000A	4000A	6400A ⁶	GTP4000U 4064
5000A	5000A	6400A ⁶	GTP5000U5064
6000A	6000A	6400A ⁶	GTP6000U6064

²AKR only. EntelliGuard™ G min. trip plug is 150A.
³PowerBreak only. EntelliGuard™ G min. trip plug is 150A.
⁴AKR only. EntelliGuard™ G min. sensor is 400A.
⁵PowerBreak only. EntelliGuard™ G min. sensor is 400A.
⁶IEC only sensor, UL equivalents are 600A.
⁷For ITE and Allis Chalmers 4000A breakers.

*Westinghouse is a trademark of Westinghouse Electric Corporation.

EntelliGuard™ TU trip unit

Conversion kit accessories and hardware



AK, AKR, Westinghouse, ITE, Allis Chalmers Conversion Kits

- EntelliGuard TU trip unit and rating plug
- Direct acting flux shifter with automatic reset
- Epoxy encapsulated high-accuracy current transformers
- Specially designed mounting hardware and wire harnesses with communication cable and RELT harness for easy upgrade later
- Detailed instruction manual

EPIC, RMS9, MVT+, MVT PM Upgrade Options

- EntelliGuard TU trip unit and rating plug
- RELT and Ground Fault Alarm Harness Kits (see below)
- RELT Switch with warning labels kit – GTURSK
- Communication cable for Modbus & 24 VDC
- Power Break II carrier plate assemblies (authorized service only)

Harness Kits and Hardware to add RELT (Reduced Energy Let Through)

Breakers	Component	Product Number	Description
All	24V Power Supply	PLPS4G01	Power Leader 1.5A power supply for up to 15 trip units
	RELT Switch Kit	GTURSK	Includes blue lighted RELT switch, lockable cover, contacts, 8' wire harness, warning labels (see picture above)
AK, AKR, Allis Chalmers, ITE, Westinghouse	RELT Harness Kit	GTURHB	4 wire RELT & Ground Fault Alarm harness kit. Used to add RELT or Ground Fault Alarm to an existing MVT installation in combination with an EntelliGuard TU. Harness comes with breaker and cubicle side, 8 feet of wire, terminal block, and RELT labels. Includes 9 pin harness for 24VDC, communications, and voltage source.
	RELT Harness Kit	GTURHA	4 wire RELT & Ground Fault Alarm harness kit. Used to add RELT or Ground Fault Alarm to an existing MVT installation in combination with an EntelliGuard TU. Harness comes with breaker and cubicle side, 8 feet of wire, terminal block, and RELT labels

EntelliGuard™ TU trip unit

Conversion kit accessories and hardware

Harness Kits and Hardware to add RELT (Reduced Energy Let Through) (continued)

Breakers	Component	Product Number	Description
Power Break I - All Frames	Power Break I Disconnect Block	TDOSD6S	Power Break I secondary disconnect 6 circuit drawout - equipment side
		TDOSD6B	Power Break I secondary disconnect 6 circuit drawout - breaker side
		TDOSVD04	Power Break I secondary disconnect with Zone Interlocking
Stationary Power Break II	RELT Harness Kit	GTURHPB2S	6 wires (4 for RELT, 2 for 24VDC) and complete wired carrier plate. Used to add RELT to an existing MVT Installation. (Installation by authorized service only)
Drawout Power Break II	RELT Harness Kit	GTURHPB2D	6 wires (4 for RELT, 2 for 24VDC), complete wired carrier plate, and 6 wire harness from terminal block to secondary disconnect. Used to add RELT to an existing MVT installation. (Installation by authorized service only)
Power Break II - All Frames	Power Break II "B" Disconnect Block	SPDOSD36S	Power Break II secondary disconnect block B - equipment side
		SPDOSD36B	Power Break II secondary disconnect block B - breaker side

Additional Key Components

Breakers	Component	Product Number	Description
All	ZSI Module	TIM1	Zone Selective Interlock Module/Repeater
	Voltage Conditioners (set of 3)	PLVC1G01	Supplies isolated bus voltage signal from PT's to EntelliGuard Trip Units (PT's not included)
	Voltage Conditioners Plate (set of 3)	See Page 8-142 BuyLog	Voltage Conditioners and Potential Transformers mounted on a metal plate with fuses
	Voltage Conditioner, PTs (set of 3) and Power Supply	See Pub DEP-056A	Includes Voltage Conditioners, Potential Transformers, 24V DC and Fuses all mounted on one Metal Plate
	EntelliGuard TEST Kit	GTUTK20	Used for testing phase currents, ground fault, disabling ground fault, RELT. Ability to Trip Breaker and used to connect to a PC with Set-up Software to download settings
	Rating Plug Removal Tool	TRTOOL	Simplifies rating plug removal
	Set-up Software	GTUSS	Set-up EntelliGuard Trip Unit offline or connected. Ability to view Waveform Captured by Trip Unit
AK, AKR, Allis Chalmers, ITE, Westinghouse	9 Pin Wire Harness Equipment side	GTUCHCONV1	9 Pin Equipment side wire harness 8' long for 24VDC, Communications, Voltage Conditioner Input
Power Break I - All Frames	Power Break Micro Switch	See Pub DEH40391	Replacement Microswitch on Power Break I's with EPIC Trip Units
Power Break II - All Frames	Plastic Door Kit	10054335P3	Power Break II Trip Unit Plastic Door

²RELT and Ground Fault Alarm require 24VDC. If 24VDC cable is required order GTURHB

EntelliGuard™ TU Trip Units are compatible with MicroVersaTrip™, RMS9, EPIC RMS9, MicroVersaTrip™ Plus and PM, Enhanced MicroVersaTrip™ Plus and PM Trip Units models.

Now Available:

Power Break™ II in a Power Break™ I (fixed and drawout)
EntelliGuard™ R Retrofill (EntelliGuard™ G in AKD-5, AKD-6, AKD-8 switchgear line-ups)

Contact factory for availability and options

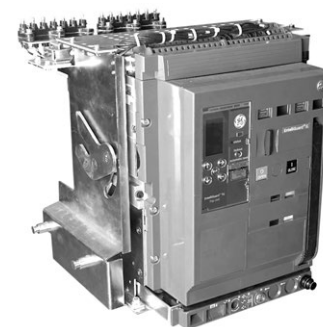

Trip unit

Accessories



Optional Remote Display

Optional Remote Display—Features

- Provides safe, convenient closed-door access to breaker metering, status and setup functions
- Available for use with either MicroVersaTrip™ Plus or MicroVersaTrip™ PM trip units
- Rugged plastic NEMA Type 1 enclosure with LCD and keypad
- Mounts easily on outside of breaker compartment door
- Sealable, clear LEXAN protective cover over display and "Enter" key prohibits unauthorized trip setting changes
- Connects to breaker trip unit via 20-pin plug-in cable for fast installation
- Breaker trip unit operates independently if cable is disconnected



Target Module

Optional Remote Display (for MicroVersaTrip™)

Accessory Type	Product Number
Remote Display w/ 6' Cable	REMDIS1
Replacement Cable	REMDIS2



ABB Trip Unit Portable Test Set

Target Module (for ProTrip™)

All ProTrip™ conversion kits come with a target module. Order another only for renewal purposes.

Product Number
TARGET02P

ABB Trip Unit Portable Test Set (for MicroVersaTrip™ and ProTrip™)

Allows for self-tests and functioning trip/no trip tests. Operates on batteries (not included) or 120 VAC source.

Product Number
TVRMS2



EntelliGuard™ TU Test Set

EntelliGuard™ TU Test Set

Allows for self-tests and functioning trip/no trip tests. Operates on batteries (not included) or 120 VAC source.

Product Number
GTUTK20

Trip unit
Accessories

POWER LEADER™ Voltage Conditioner

Conditions and scales 120Vac to 1.76Vac for use by the trip unit for voltage sensing. Provides transient protection. Requires isolation PTs with 120 volt secondary. Supports up to 15 trip units at a maximum distance of 20 feet. Required for PM trip units only.

Description	Product Number	System Requirements (Not included with voltage conditioners)
Supplies isolated bus voltage signal to MicroVersaTrip™ PM trip units.	PLVC1G01	One set of 3 voltage conditioners required for each sensing location. PTs also required.

MicroVersaTrip™ Portable Power Pack

The MicroVersaTrip™ Portable Battery Pack is a maintenance power source used to power up trip units for setting or adjusting trip set points or for reading trip targets when the trip unit is not otherwise energized. It is a redundant power source to the onboard battery supplied with the Enhanced MicroVersaTrip™ Plus and PM (5-button keypad) trip units. The portable battery pack connects to the trip unit through the rating plug test jack. It requires three (3) standard 9Vdc alkaline batteries (not included).

Description	Product Number
MicroVersaTrip™ Portable Power Pack	TVPBP

MicroVersaTrip™ and EntelliGuard™ Rating Plug Removal Tool

Description	Product Number
MicroVersaTrip™ and EntelliGuard™ Rating Plug Removal Tool	TRTOOL

Asbestos free arc quencher replacement kits

ABB's Asbestos Free Arc Quencher Replacement Kits are designed to replace asbestos plate style arc quenchers on AK and early AKR power circuit breakers with reliable, proven steel plate style arc quenchers used on modern AKR breakers. The kits have been ANSI C37.59 tested for dielectric and short circuit ensuring breaker performance to original specifications. On most AK series breakers, no modifications are needed to install the arc quencher replacement kit. Installation is typically done in less than one hour (see Installation Instructions GEH-6464). Asbestos Free Arc Quencher replacement kits are shipped complete with detailed installation instructions and everything you need for fast and easy arc quencher replacement:

- Asbestos free metal plate or ceramic arc quenchers
- Contact guides and arc runners (when required)
- Asbestos free replacement barriers (when required)
- All required mounting hardware (authorized service only)

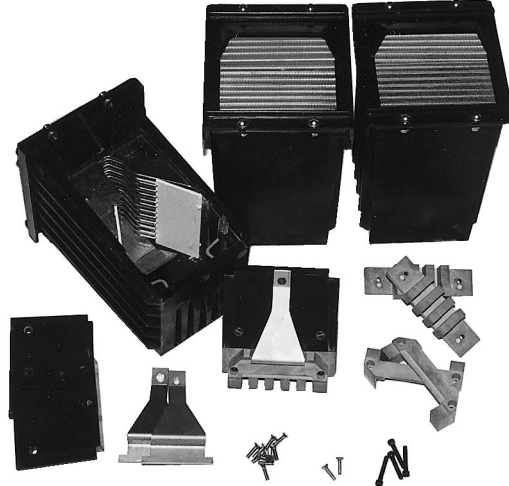

Reference Publications

Asbestos Free Arc Quencher Replacement Kits	DET-096
Installation Instructions	GEH-6464

Product Number Selection

Breaker	AKO25
AK-15	
AK-25	AKO25 ^{1,2,3}
AKU-25	
AKR-30S	AKR3S ^{1,2}
AKR-30	AKR30
AKRU-30	
AKR-30H	AKR3H
AKRU-30H	
AK-50	
AKT-50	AKO50 ^{2,3}
AKU-50	
AKJ-50	
AKJT-50	
AKJU-50	AKR50
AKR-50	
AKRT-50	
AKRU-50	
AKJ-50H	
AKJT-50H	
AKJU-50H	AKR5H
AKR-50H	
AKRT-50H	
AKRU-50H	
AKJ-50	AKD50 ⁴
AKJT-50	
AKJU-50	
AKJ-50H	
AKJT-50H	AKD5H ⁴
AKJU-50H	
AK-75	AKO75 ^{2,3}
AKR-75	AKR75 ²
AK-100	AKO10 ^{2,3}
AKR-100	AKR10 ²

Model	AQR1	G1	Application
AQR1	Arc Quencher Replacement Kit Generation 1		For Asbestos Removal G1
			Renewal Kit for Ceramic Arc Quenchers G2

Arc Quenchers Replacement Kit

Product Number	
AKO25AQR1	G1
AKR35AQR1	G1
AKR30AQR1	G1
AKR30AQR1	G2
AKR3HAQR1	G1
AKR3HAQR1	G2
AKO50AQR1	G1
AKR50AQR1	G1
AKR50AQR1	G2
AKR5HAQR1	G1
AKR5HAQR1	G2
AKD50AQR1	G1
AKD50AQR1	G2
AKD5HAQR1	G1
AKD5HAQR1	G2
AKO75AQR1	G1
AKR75AQR1	G1
AKO10AQR1	G1
AKR10AQR1	G1

¹Kits contain replacement barriers only, arc quenchers do not contain asbestos.

²G2 kits are not available for these breakers, please contact the factory for individual replacement arc quenchers.

³Does not apply to AK-1 series breakers.

⁴These kits are for use on breakers used in AKD and AKD-5 switchgear and substructures.

Gerapid high speed DC circuit breakers

Typical Traction Electric Power System

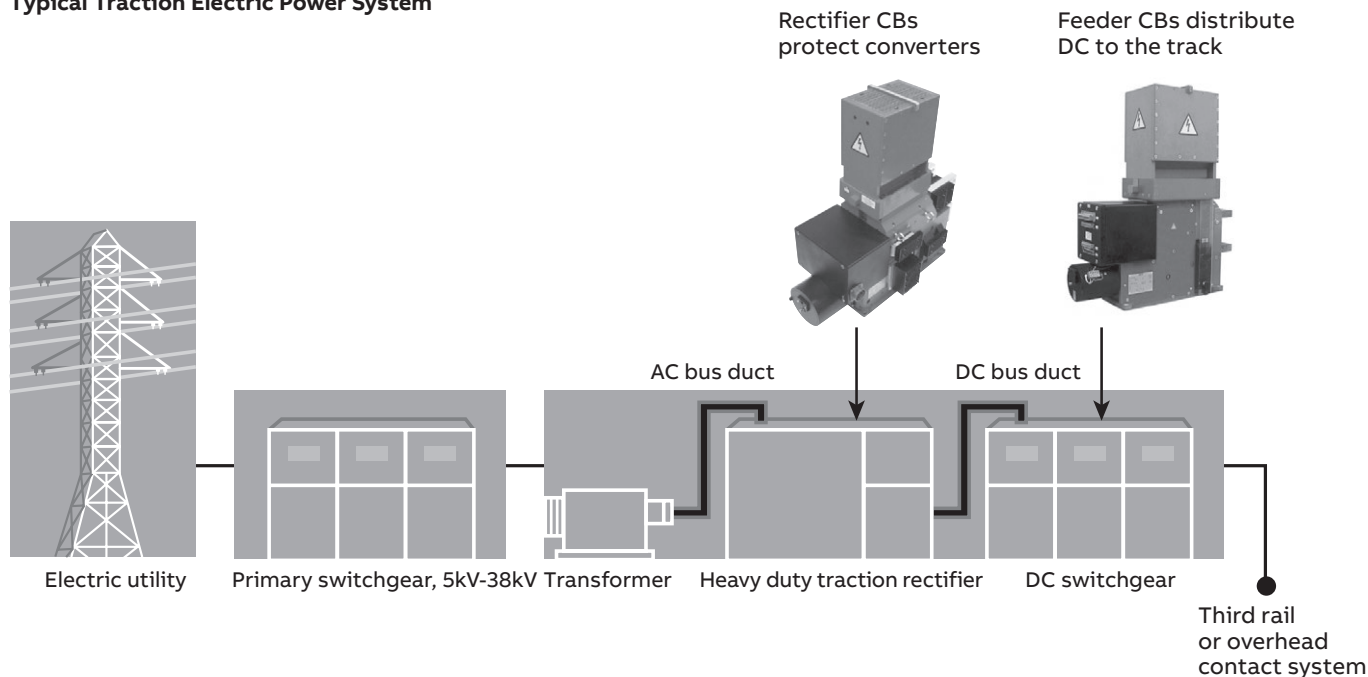

In addition to traction substation applications, Gerapid can be used as a feeder breaker in various other installations such as industrial plants (metals industry), as field breakers for motor and generator field applications, and as disconnects for DC drives, to name a few.

Circuit Breaker Features and Accessories

- Insulated side plates with adjustable dial for setting over current trip (OCT) (optional)
- Mechanical forced tripping
- Electrodynamic trip device (with or without capacitor and charging unit)
- Shunt trip
- No-voltage release
- Breaker auxiliary contacts (up to 10 form C)
- Additional auxiliary contacts for signaling (optional)
- Main terminal configurations variable
- Plug connectors for auxiliary circuits (optional)
- Hand lever for manual actuation from front (for maintenance purposes only)
- Position indication (optional)
- Internal power supply with a wide range of supply voltage options
- Integrated current measurement unit (SEL) (optional)
- Mechanical counter

Key Benefits

- Standard dimensions from 2,600A to 6,000A (feeder models GER2607 – GER8007)
- Operating voltages from 1,000 to 3,600Vdc
- Mining and traction compliant (ANSI C37.14, IEC 947-2, EN 50123-2). Also available with UL label.
- High speed OPEN/TRIP (opening delay <3ms)
- Direct acting instantaneous and adjustable trip unit works without imported energy and is available as bidirectional symmetrical (for line feeder) or unidirectional (for rectifier breaker)
- High speed CLOSE (approximately 150 ms)
- Solenoid drive (integral control unit, mechanically latched, no auxiliary power required to keep contacts closed)
- 2-stage contact system minimizes contact wear
- Compact, enclosed construction
- Modular, serviceable design
- Easily accessible control and auxiliary connections
- Fixed and draw-out versions
- Extensive accessories/options

General Information

Rated Temperature	-5° to 40°C ambient (55°C with reduced ratings)
Relative Humidity	90% @ T<20°C; RH=130-2*T @ T>20 °C
Altitude	-120m to 2000m above sea level

Gerapid high speed DC circuit breakers

Gerapid Breaker Modules

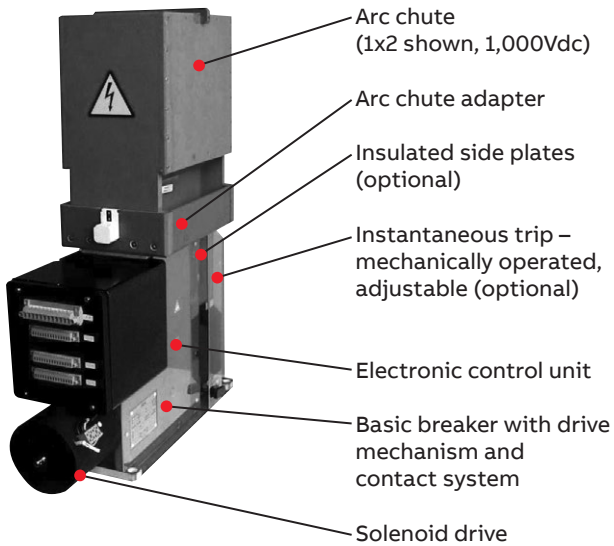

Power and Control Connections

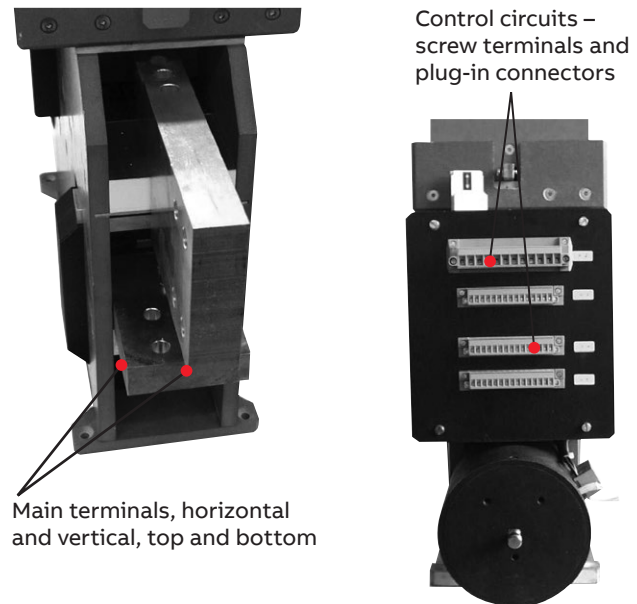

Type SEL Current Measurement System (optional on 2607 and 4207)

- Current measurement at the breaker
- Factory-equipped or field-installable
- No additional space required or breaker modifications
- Ranges 6kA and 12kA
- To 4,000Vdc
- Signal output via 3 interfaces
- 4...20mA
- +/- 20mA
- +/- 10V
- Watchdog function standard

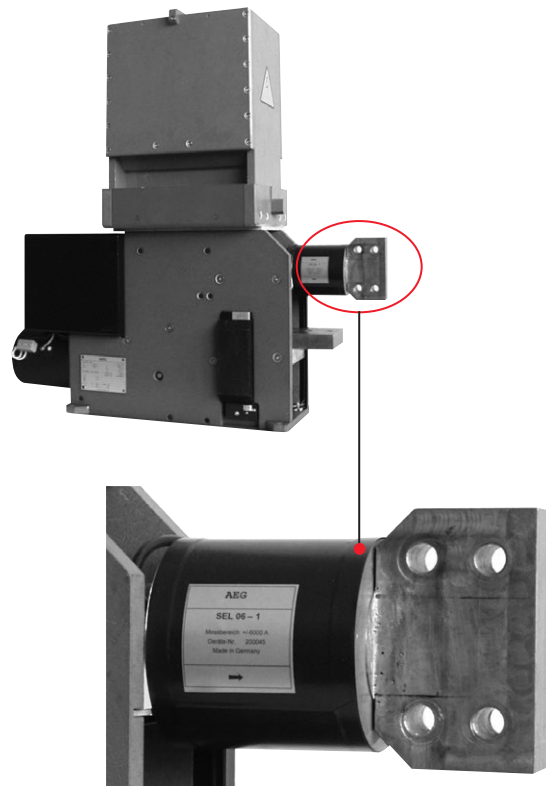

Gerapid high speed DC circuit breakers

Technical Data for Feeder Circuit Breaker Models 2607 through 8007

Breaker type	Gerapid 2607					Gerapid 4207					Gerapid 6007					Gerapid 8007	
	1X2	1X4	2X2	2X3	2X4	1X2	1X4	2X2	2X3	2X4	1X2	1X4	2X2	2X3	2X4	1X2	2X2
Arc chute type																	
Conventional thermal current I _{th} [A] (IEC/EN)	2600					4200					6000					8000	
Rated current [A] (ANSI/IEEE C37.14)	2600					4150					N/A					6000	
Rated voltage U _{Ne} [V] (EN 50123 / IEC 60947)	1000	2000	2000	3000	3600	1000	2000	2000	3000	3600	1000	2000	2000	3000	3600	1000	2000
Rated maximum voltage [V] (ANSI/IEEE C37.14)	800	N/A	N/A	N/A	N/A	800	N/A	1600	N/A	N/A	N/A	N/A	N/A	N/A	N/A	800	N/A
Rated insulation voltage U _i [V] (EN 50123 / IEC 60947)	2000	2000	2000	3000	4000	2000	2000	2000	3000	4000	1000	2000	2000	3000	4000	1000	2000
Short time current 120 min [A] (EN 50123 / IEC 60947)	3150					5000					7200					9600	
Short time current 2 min [A] (EN 50123 / IEC 60947)	5200					8500					12000					16000	
Short time current 20 sec [A] (EN 50123 / IEC 60947)	7800					12600					18000					24000	
Impulse withstand voltage 1.2/50 μs U _i [kV] according to EN 50124-1:1997	18	18	18	30	30	18	18	18	30	30	12	18	18	30	*	12	18
Power frequency withstand voltage 50 Hz U _a [kVeff] according to EN 50124-1:1997	10	10	10	15	15	10	10	10	15	15	7	10	10	15	*	7	10
Rated short circuit making capacity I _{ss} [kA]	70	50	100	50	42	70	50	100	50	42	70	50	80	50	*	70	*
Rated short circuit breaking capacity according to EN 50123-2 I _{ns} [kA]	50	35	71	35	30	50	35	71	35	30	50	35	56	35	*	50	50
Rated service short circuit breaking current according to IEC 947-2 I _{cs} [kA]	60	40	50	40	40	60	40	50	40	40	60	40	50	40	*	60	*
Short circuit current according to IEEE C37.14 [kA]	120	-	-	-	-	120	-	60	-	-	-	-	-	-	-	120	*
Peak current according to IEEE C37.14 [kA]	200	-	-	-	-	200	-	100	-	-	-	-	-	-	-	200	*
Maximum short circuit current tested at customer request [kA]	244	120	100	-	52	244	120	100	-	52	200	-	-	-	-	240	-
Maximum arc voltage U _{arc} [kV] (EN 50123 / IEC 60947)	2	4	4	5.6	7	2	4	4	5.6	7	2	4	4	5.6	7	2	4
Weight ca. [kg]	120	120	160	160	160	120	120	160	160	160	150	150	165	165	165	190	210
Weight ca. [lbs]	265	265	352	352	352	265	265	352	352	352	331	331	364	364	364	419	463

*Test data available at customer request

Technical Data for Rectifier Circuit Breaker Models 8007R and 10007R

Parameter	Reference	Gerapid 8007R		Gerapid 10007R	
Arc chute type	N/A	1x2	1x3	1x2	1x3
Rated continuous current [A]	ANSI C37.14 p.5.3	6000	6000	8000	8000
2 hours current [A]	N/A	7200	7200	9600	9600
2 minutes current [A]	N/A	12000	12000	16000	16000
20 seconds current [A]	N/A	18000	18000	24000	24000
Rated short-time current (250ms) [kA]	ANSI C37.14 p.5.5	90 (149 peak)	60 (100 peak)	90 (149 peak)	60 (100 peak)
Rated maximum voltage [V]	ANSI C37.14 p.5.2	800	1200	800	1200
Rated insulation voltage - U _{Nm} [V]	EN 50124-1 p.1.3.2.4	2000	2000	2000	2000
Rated impulse voltage - U _{Ni} [kV]	EN 50124-1 p.1.3.2.7	18 [12/50 μs]	18 [12/50 μs]	18 [12/50 μs]	18 [12/50 μs]
Power frequency voltage - U _a [kV]	EN 50124-1 a.B 2.2	10 [1 minute 50 Hz]	10 [1 minute 50 Hz]	10 [1 minute 50 Hz]	10 [1 minute 50 Hz]
Mechanical endurance [cycles] ¹	N/A	10.000	10000	10000	10000
Rated short circuit peak / sustained current [kA] 2,3	ANSI C37.14 p.5.4	200 / 120	132 / 80	200 / 120	132 / 80
Short-circuit characteristic	Tests a, b, c, d acc. ANSI C37.14 annex A	High-speed	High-speed	High-speed	High-speed
Maximum arc voltage [V]	N/A	2500	2500	2500	2500
Mass ca.	N/A	220 kG	220 kG	220 kG	220 kG

¹10000 cycles without parts replacement. Inspection after 5000 cycles. Max. 5000 cycles by means of ED impulse coil or POCT release.

²Tested for high and low frequency impedance bonds.

³Trip by means of POCT (direct-acting, instantaneous, electromechanical and polarized OC release) or by means of ED impulse coil with no intentional delay

To configure Gerapid OEM Modules and DC Circuit Breakers, visit our web wizard configuration tool at: http://electrification.us.abb.com/cwc/Dispatcher?REQUEST=PRODUCTS&id=gerapid&lang=en_US

Gerapid high speed DC circuit breakers

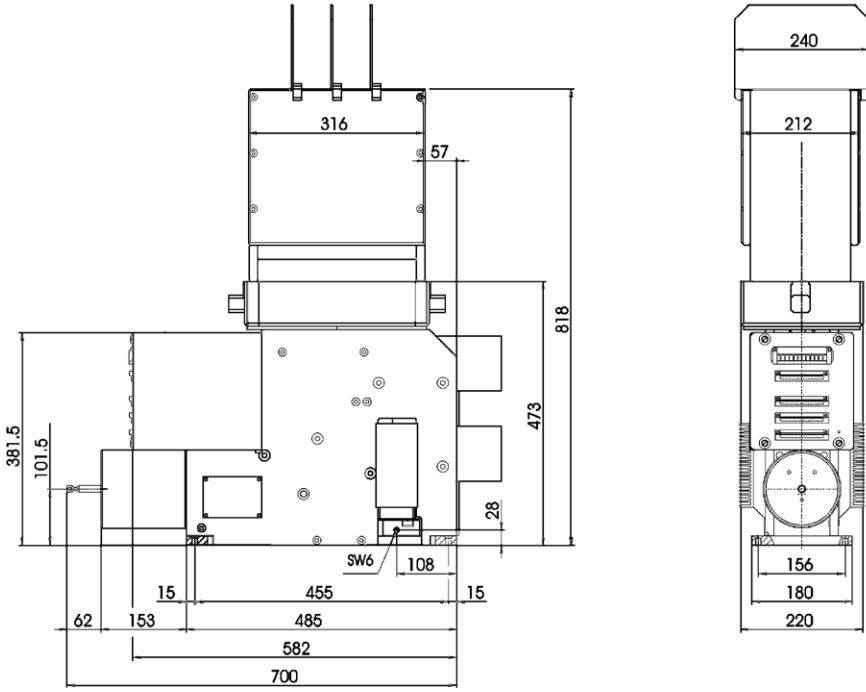

Figure 1. Models 2607 - 6007 Feeder CBs, 1X4 Arc Chute, 2,000Vdc (Dimensions in mm)

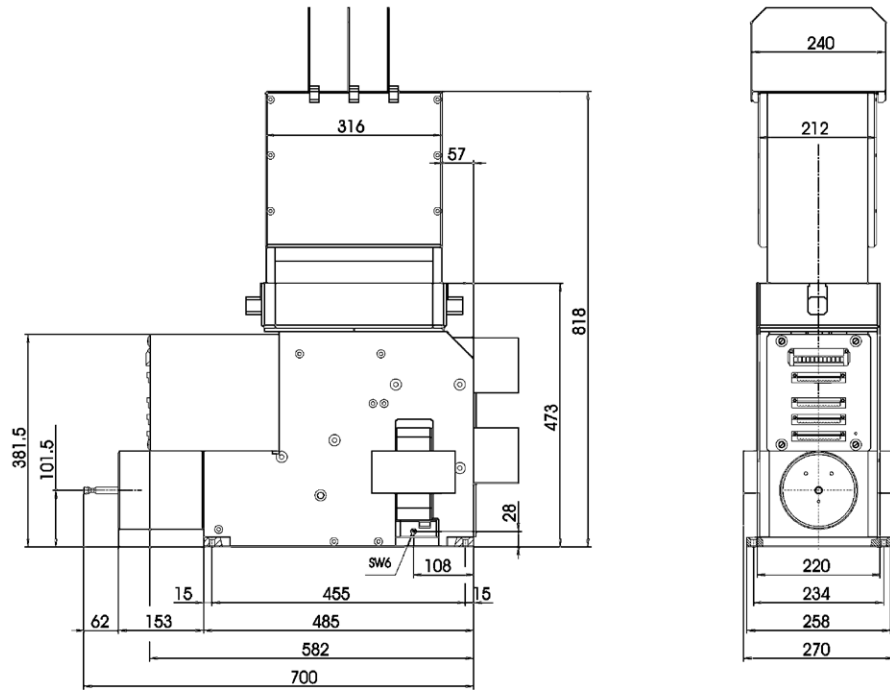

Figure 2. Gerapid 8007 Feeder CBs, 1X4 Arc Chute, 2,000Vdc (Dimensions in mm)

Gerapid high speed DC circuit breakers

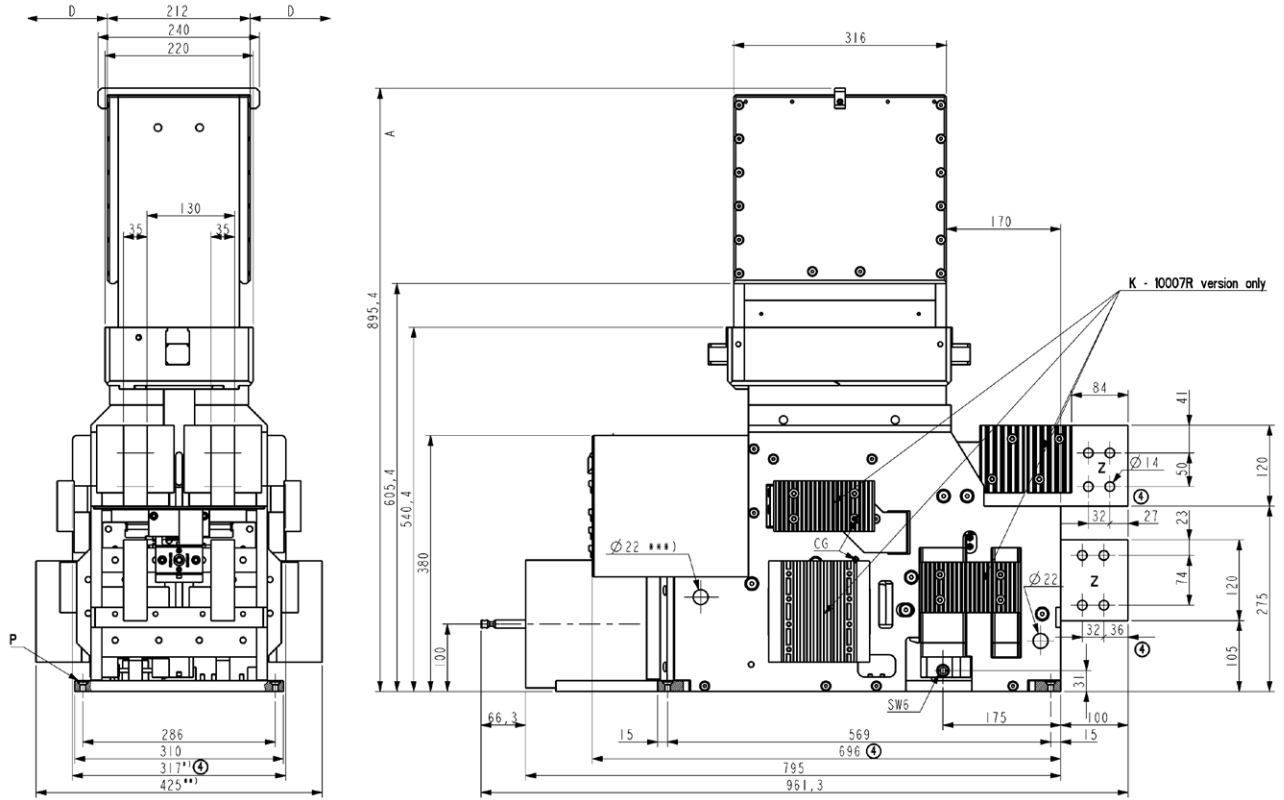

Figure 3. Gerapid 8007R and 10007R Rectifier CB, 1X2 Arc Chute, 800Vdc (Dimensions in mm)

Power Break™ II circuit breakers

Features

Power Break™ II Circuit Breakers

The Insulated Case Circuit Breaker—ABB pioneered the design and created the name in 1965. ABB Power Break™ II insulated case circuit breakers are the latest in reliable, flexible and easy-to-use circuit protection.

Power Break™ II circuit breakers are UL Listed, CSA and IEC-947-2 Certified for up to 200,000 amperes, at 240 volts rms symmetrical interrupting capacity without fuses or current limiters. These new insulated case circuit breakers rated 200-4000A can be applied on ac power systems through 600 volts. All breaker frames, except 4000A stationary, are UL Listed to carry 100% of their ampere rating continuously. All frames are suitable for reverse feeding.

All Power Break™ II circuit breakers are available in two levels of interrupting capacity—“standard break” and “Hi-Break” breakers. Each interrupting level is available in both stationary and draw-out construction, with a full complement of control and signaling accessories.

Standard break breakers are designed to meet the majority of application requirements, calling for moderate levels of available short-circuit current.

Hi-Break breakers are specially designed to withstand the stresses, and safely interrupt high levels of short-circuit current found in some applications (from 65 to 200 kA rms symmetrical amperes—depending on voltage).

Greater Convenience and Operational Safety

The controls and status indicators you need most are readily accessible. The flush-mounted handle, ON/OFF buttons, rating plug test receptacle, bell alarm reset buttons — with or without lockout — are easily reached and all are double-insulated from live components. And, for added security, a standard padlock device lets you prevent accidental or unauthorized closing of the breaker.

Power Break™ II circuit breakers are versatile and designed for a wide variety of applications including temperature insensitive trip units, push-to-open and close control, charge-after-close operation, 3 cycle closing, UL listed (file E 11592) field installable accessories suitable for 50/60 Hz. All accessories and control wiring are prewired to dedicated, secondary terminal points on each breaker.

Quick, Error-Free Installation of Universal Accessories

Drop-in bell alarm, bell alarm with manual reset lockout, shunt trip, shunt trip with lockout, and undervoltage release install in seconds. No special tools. No breaker disassembly. Just slide them into place. The modules are universal across all frame sizes and each is mechanically keyed to its compartment so you make the right connection, every time. These accessories are field installable and upgradable.



ABB's innovative, modular, drop-in accessories provide the ultimate customer solution for field customization:

UL Listed

- Accessory combination (one each) shunt trip, undervoltage release, bell alarm (alarm only), bell alarm with lockout.
- Rated 12-250 Vdc through 12-240 Vac, continuous duty.

Complete installation in seconds without special tools, breaker disassembly or adjustment

- The user can select how protective trip unit functions, the shunt trip (with or without lockout), and UVR accessories interface with the bell alarm and bell alarm with lockout accessories: An overcurrent, shunt trip, or UVR trip can be set to actuate the bell alarm or bell alarm with lockout. Any combination of output actions based on inputs can be selected.
- Shunt trip and undervoltage trip targets are clearly displayed by the trip unit LCD.

Pre-wired wire harness makes field installation a snap for:

- Motor operator with remote charge indicator
- Auxiliary switches, up to 12-stage maximum
- Remote close solenoid

Additional field-installable accessories including:

- Kirk Key locks (4 maximum)
- Limited access ON/OFF cover
- Mechanical operations counter
- Door interlock
- Walking beam interlock for stationary and draw-out breakers.

Ratings for Global Use

- Performance ratings include IEC947-2 certification.

Power Break™ II

Construction options

The interruption ratings and voltages shown in the table are maximum ratings. A circuit breaker of the type given in the lefthand column may be applied at the given circuit voltage in any electrical distribution system where the available fault current at the load terminals of the breaker does not exceed the value in the table. That circuit breaker type may also be applied at intermediate values of circuit voltage provided the available fault current at the load terminals of the breaker does not exceed the value in the table for the higher value of voltage.

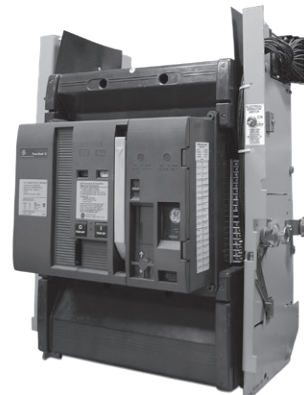

Insulated Case Circuit Breakers

	Circuit Breaker Envelope Size (Amperes)	EntelliGuard™ TU	Trip Types		Molded Case Switch	Max IC @ 480V (kA)	Max Voltage Rating (ac)	Max Frame (Amperes)
			Power+	MicroVersaTrip™ Plus/PM				
Power Break™ II								
Standard	800	•	•	•		65	600	800
	1600	•	•	•		65	600	1600
	2000	•	•	•		65	600	2000
	3000	•	•	•		100	600	3000
	4000	•	•	•		100	600	4000
Hi-Break	800	•	•	•		100	600	800
	1600	•	•	•		100	600	1600
	2000	•	•	•		100	600	2000
	3000	•	•	•		150	600	3000
	4000	•	•	•		150	600	4000
Molded Case Switch	800				•	30 ¹	600	800
	1600				•	40 ¹	600	1600
	2000				•	40 ¹	600	2000
	2500				•	42 ¹	600	2500
	3000				•	42 ¹	600	3000
	4000				•	42 ¹	600	4000

¹Molded case switch ratings are short time @ 600Vac, not interrupting current. See page 8-166 for withstand ratings.

Power Break™ II circuit breakers

EntelliGuard™ TU trip unit features

EntelliGuard™ TU Trip Units

New capabilities in the EntelliGuard™ TU Trip Unit provide ultimate system reliability and selectivity without sacrificing circuit protection. This superior addition enhances the Power Break™ II breaker with a Waveform Recognition Instantaneous Algorithm that eliminates costly downtime due to nuisance tripping. It enables harmonic analysis four cycles prior and after an event, and discerns whether a downstream breaker/fuse is clearing the fault. The unit also includes Zone Selective Interlocking (can be used as a feeder and downstream device with a power circuit breaker upstream) which delivers simultaneous and independent ZSI of Short Time, Ground Fault and Instantaneous protection, providing the ability to overlap the Instantaneous on the Main and Feeder breakers. Together, these innovative abilities achieve Hazard Risk Category 2 (HRC2) with currents as high as 100kA with simultaneous flash protection and selectivity.

The EntelliGuard™ TU Trip Unit offers optimum circuit safety and arc flash protection with the Reduced Energy Let-Through function, providing a faster instantaneous trip that may be used if faster and more sensitive protection is required temporarily. It is commonly referred to as an “Arc Flash Switch” or “Maintenance Switch”.

The new and improved trip unit design delivers selectivity tools not previously available in ABB circuit breakers:

Exclusive EntelliGuard™ TU Trip Unit Features Designed for Flexibility

- A wide range of continuous adjustment Long Time delays ensure the circuit breaker can be exactly adjusted in to your selectivity and protection needs.
- Multiple Short Time diagonal bands tune your protection to exactly where it needs to be.
- Flexible time current settings and curves -Standard Long Time characteristics exactly mimic the curve of a thermal magnetic circuit breaker.
- Flexible Time Current Curves: 44 Long Time Shapes I^2T and I^4T (fuse), 3 Short Time I^2T slopes, Short Time adjustable in 55 ms increments, and 4 Ground Fault curves to select from (I^2T , I^4T , SGF, Define Time Slope)

Instantaneous Protection

- Instantaneous pick-up is adjustable up to 15 times the plug rating on frames 800-2000A, 13 times on 3000A frames and up to 9 times on 4000A frames.
- A separately adjustable fast instantaneous trip - useful for when the circuit must provide the best possible protection and arc flash performance while sustaining normal load.
- An override instantaneous - provides fast tripping for the largest bolted fault currents to minimize potential damage.
- Up to 17 Short Time bands allow you to set your circuit breaker to sustain load requirements without slowing protection.
- Ground Fault Alarm via I/O or Modbus Communications
- Ground fault protection with faster time bands, multiple slopes and the ability to coordinate a 1200A ground fault with an 800A circuit breaker – a ratio four times better than in previous generation trip units



Maintenance and Diagnostics

- Universal trip plug fits any trip unit.
- Flexible serial communication via Modbus RTU
- Integrates directly into ABB's EnerVista™ Power Management System.
- Large backlit LCD with detailed, easy-to-see descriptions.
- Health status via breaker LED indicating normal operation, errors, pickup, and trips while providing non-volatile memory with a continuous self-testing microprocessor
- Lithium battery to eliminate need for external power for set-up and review
- 10 event Log with Date/Time Stamp: Stores the last 10 events. Date/Time with 24Vdc Power.
- Thermal Memory
- WaveForm Capture: 40 Samples/Cycle, 4 cycles prior and 4 cycles post event in COMTRADE format.
- Free set-up software

Power Break™ II circuit breakers EntelliGuard™ TU trip unit features

Power+ Trip Unit Systems

The Power+ trip unit system for Power Break™ II insulated case breakers consist of the trip unit, the trip actuator, current sensors and rating plugs. The term “trip unit system” applies to the combination of these four components which form the solid-state circuit breaker tripping system.

Power+ trip units provide a complete range of standard and optional overcurrent and ground-fault protective functions.



True RMS Sensing

The Power+ trip unit continues to use ABB’s proven technique of measuring true rms currents of both sinusoidal and harmonically distorted waveforms. The frequent sampling (48 times per cycle per phase) allows precise calculations of true rms current. The sampling rate allows waveform measurements up to the 11th harmonic. ABB’s true rms sensing avoids potential underprotection or overprotection problems associated with peak-sensing tripping systems.

Accessory Integration

Four accessories are integrated through the Power+ trip unit. Drop-in shunt trip (with or without lockout), bell alarms (with or without lockout) and the undervoltage release modules fit into keyed pockets. They operate through the trip units, and not through any external mechanisms. All accessory wiring is prewired to secondary terminals, and no user wiring is necessary. When activated, the shunt trip (with or without lockout) and undervoltage release modules send a signal to the trip unit to energize the trip actuator and open the breaker.

Trip Target Module (Optional)

View Button: Press the VIEW button to check the trip unit status.

Reset Button: Press the RESET button to clear any target that is set.

Battery check: Target modules use two standard, 3V, 16mm x 1.6mm, lithium batteries for viewing target information. Battery life depends upon use, but may be estimated at one year. When the batteries are energized, depressing the VIEW button will illuminate either a set target LED, i.e., LT or the BAT LED. Once target indicators are cleared, battery status is indicated by the BAT LED. Replacement batteries include Panasonic CR1616, Eveready E-CR1616BP, or Duracell DL1616B, which may be purchased commercially.



Power+ Trip Target Module

Long-time pickup: The long-time pickup indicator moves through two transitions. As the current in any phase reaches 95% of its setpoint; the LTPU LED begins to flash. As current increases, flashing frequency increases, until 100% of the pickup point is reached. At that moment, the LTPU LED stays on continuously until the long-time delay times out. Once the breaker has tripped on long-time, the Overload target will be stored in memory. To view the trip, press the VIEW button. To clear the target, press the RESET button.

Short-time and instantaneous trips: Short-time and instantaneous trips share the same trip target. The LTPU LED is not illuminated, since the time intervals between pickup and tripping are too short for either function. Once the breaker has tripped on short-time or instantaneous, the short target will be stored in memory. To view the trip, press the VIEW button. To clear the target, press the RESET button.

Ground fault trip (Target02 only): The trip target for a ground fault trip is the GF LED. To view the trip, press the view button. To clear the target, press the RESET button.

Health monitor: Trip unit health status “okay” is illustrated by slow blinking of the LTPU LED. It may be seen by depressing and holding the VIEW button. Sufficient power must be supplied to the trip unit via external test kit, power pack, or current transformers for the health monitor to be operational.

Standard and Optional Protective Functions

Standard and optional protective functions are available for Power+ trip units. The breaker settings are programmed in multiples of “X” (rating plug ampere values), “S” (current sensor ampere rating values), and “C” (the long-time setting in amperes—multiply long-time setting by rating plug ampere rating).

Standard

- Adjustable Long-Time (L) Pickup, 0.5 - 1.0X, with four delay bands.
- Adjustable Instantaneous (I) Pickup, 1.5 - 15X.

Options

- Overload, Short Circuit, and Short-Time local trip indicators with overload pickup warning and health monitor.
- Adjustable Short-Time (S) Pickup, 1.5 - 9.0C, and delay (3 bands) with I2t ON/OFF selection.
- Adjustable Ground Fault (G) Pickup, 0.2 - 0.6S, and delay¹ (3 bands) with I2t ON/OFF selection and trip indicator.
- Upgradeable Ground Fault function with use of appropriate ground fault rating plug.

¹Limited by breaker frame size above 2000A.

Power Break™ II circuit breakers

Enhanced MicroVersaTrip™ trip unit features

Enhanced MicroVersaTrip™ Trip Units

Enhanced MicroVersaTrip™ Plus and MicroVersaTrip™ PM trip units give you two new ways to monitor and control the Power Break™ II breaker with unprecedented ease. Through the simple keypad, the trip unit lets you program and display a variety of functions including tripping characteristics, remote communications, status information and protective relaying, and allows integration with ABB POWER LEADER™ Power Management Systems. The trip unit display also allows viewing of many standard metering parameters as well as pickup alarms, trip target indications and fault status information.

Enhanced MicroVersaTrip™ Plus and MicroVersaTrip™ PM trip units continue to use ABB's proven technique of measuring true rms currents (and voltages for MicroVersaTrip™ PM trip units) of both sinusoidal and harmonically distorted waveforms. The frequent sampling (64 times per cycle) allows precise calculations of true rms current. The sampling rate allows waveform measurements up to the 31st harmonic to achieve accuracies of 99%. ABB's true rms sensing avoids potential underprotection or overprotection problems associated with peak-sensing tripping systems.

The enhanced trip unit design includes a wide range of functions and adds many new features:

UL Listed Field-Interchangeable

Non-volatile trip targets display/Cold setup capability

- Replaceable long-life batteries provide trip target indications and cold setup capability—without the need for external power or a battery pack.

Trip operations counter

- The number of long-time, short-time, instantaneous and ground fault trips are individually counted and displayed.

Trip information

- On overcurrent faults, the trip unit displays fault pickup, the type of fault, the magnitude of the fault current and the phase the fault occurred on.
- Display indicates when a short trip or undervoltage release trip has opened the breaker.

New display

- Ergonomic, 5-button keypad
- New targets with international symbols
- High-resolution LCD display for local 3-phase ammetering
- New status and setup displays for greater ease of use
- True rms sensing for accurate response to high harmonic content waveforms for Long-Time, Short-Time, and Ground Fault protection.
- 50/60 Hz operation.
- Interchangeable, UL Listed trip units and rating plugs with testset jack for TVRMS2 test set.
- EMI immunity per ANSI C37.90.



Enhanced MicroVersaTrip™ Plus and MicroVersaTrip™ PM Trip Units have been specifically designed to integrate with the extensive capabilities offered by Power Break™ II circuit breakers.

Features exclusive to MicroVersaTrip™ PM Trip Units

Communications

- All information can be viewed on the LCD display or communicated over a POWER LEADER™ Power Management System network.

Demand/peak demand

- The trip unit can display a rolling average of power demand and peak power demand at user-selected intervals from 5 to 60 minutes.

Local and remote metering

- Amps, volts, frequency
- Real power, total power
- Accumulated energy

Protective relays include:

- Current and voltage unbalance
- Overvoltage
- Undervoltage
- Power reversal
- Power reversal direction setup

Power Break™ II circuit breakers

Trip unit characteristics

EntelliGuard™ TU Trip Unit Characteristics

Envelope Size	Frame Max. Ampere Rating	Sensor Rating Amperes (S)	Long Time			Short Time	Delay (Seconds)	
			Delay ² (Seconds)	Current Setting (C) (Pick-Up Multiple of Rating Plug Amperes (X))	Thermal Type (C-Bands)			Fuse Type (F-Bands)
800	800	200, 400, 800	0.5 thru 1.0 in Increments of 0.05	0.20	0.025	1.5 thru 9.0 in Increments of 0.5	I ² T in ¹ Minimum - .046 Intermediate- .186 Maximum - .418	
1600	1600	800, 1000, 1600		0.60	0.025			
2000	2000	2000		1.21	0.025			
				1.61	0.032			
3000	2500	1000, 2000, 2500		2.41	0.044			
				3.21	0.059			
	3000	3000		4.02	0.078			
				4.82	0.100			
	4000	4000		4000	5.62			0.130
					6.43			0.170
				7.23	0.220			
				8.04	0.270			
			9.64	0.350				
			11.20	0.440				
			12.90	0.550				
			14.50	0.690				
			16.10	0.870				
			17.70	1.100				
			19.30					

Trip Unit Characteristics (continued)

Envelope Size	Adjustable Instantaneous Pick-Up without ST (Multiple of Rating Plug Amperes) (X)	Adjustable Instantaneous Pick-Up with ST (Multiple of Rating Plug Amperes) (X)	RELT without ST	RELT without ST	Ground Fault Pick-Up (Multiple of Sensor Ampere Rating)	Delay with I ² T in Seconds	Slope Bands	Fixed Delay
1600	2.0 thru 10.0 in 0.5 increments	2.0 thru 15.0 in 0.5 increments	1.5 thru 10.0 in 0.5 increments	1.5 thru 15.0 in 0.5 increments	0.20 thru 0.60 in increments of 0.01	0.092		
2000	2.0 thru 10.0 in 0.5 increments	2.0 thru 15.0 in 0.5 increments	1.5 thru 10.0 in 0.5 increments	1.5 thru 13.0 in 0.5 increments	0.20 thru 0.60 in increments of 0.01	0.117		
3000	2.0 thru 10.0 in 0.5 increments	2.0 thru 13.0 in 0.5 increments	1.5 thru 10.0 in 0.5 increments	1.5 thru 13.0 in 0.5 increments	0.20 thru 0.37 in increments of 0.01	0.158		
4000	2.0 thru 9.0 in 0.5 increments	2.0 thru 9.0 in 0.5 increments	1.5 thru 9.0 in 0.5 increments	1.5 thru 9.0 in 0.5 increments	0.20 thru 0.30 in increments of 0.01	0.183		
								0.217
								0.350
								0.417
								0.517
								0.617
								0.717
								0.817
								0.917

Additional Features and Characteristics of the EntelliGuard™ TU Trip Unit

Function	Description	Trip Unit Character 9														
		1	2	3	4	5	6	7	8	9	X	A ³	B ³	C ³	D ³	E ³
Metering																
Communications	Modbus Communications Bus Link		•				•									•
Amperes (A, kA) ²	Selectable Phase Current ± 2.5%	•	•		•	•	•		•		•	•	•	•	•	•
Voltage (V)	L-L or L-N Volts ±1.5%				•	•	•		•				•	•	•	•
Energy (kWh,MWh,GWh)	Total Energy Usage on Brkr ± 4%				•	•	•		•				•	•	•	•
Real Power (kW/MW)	L-L or L-N Power ± 4%				•	•	•		•				•	•	•	•
Total Power (kVA/MVA)	L-L or L-N Power ± 4%				•	•	•		•				•	•	•	•
Frequency (Hz)	Circuit Frequency ± 1Hz				•	•	•		•				•	•	•	•
Demand & Peak Demand (kW)					•	•	•		•				•	•	•	•
Relaying																
Under Voltage Trip	Adjustable pickup, 50-90% Adjustable delay, 1-15 seconds OFF					•									•	•
Over Voltage Trip	Adjustable pickup, 110-150% Adjustable delay, 1-15 seconds OFF					•									•	•
Voltage Unbalance	Adjustable pickup, 10-50% Adjustable delay, 1-15 seconds OFF					•									•	•
Current Unbalance	Adjustable pickup, 10-990kW Adjustable delay, 1-15 seconds OFF Power Reversal Direction					•									•	•
Data Acquisition - Waveform Capture																
RELT		•	•		•	•	•		•						•	•

³Used when Ground Fault Alarm is needed via the output contact.

Additional Features and Characteristics of the EntelliGuard™ TU Trip Unit

Trip Unit Character 3	Zone Selective Interlocking	Power Break™ II
Z	ZSI, Short time and GF; user selectable	•
T	Z + IOC ZSI; user selectable	• ¹
X	NONE SELECTED	•

¹Instantaneous out only.

²Time delay shown at lower limit of each band. All pick-up tolerances are ±10%.

Power Break™ II circuit breakers

Trip unit characteristics

Power+ Trip Unit Characteristics

Envelope Size	Frame Max. Ampere Rating	Sensor Rating Amperes (S)	Long Time		Short Time	
			Current Setting (C) (Pick-Up) Multiple of Rating Plug Amperes (X)	Delay ¹ (Seconds 4 Bands)	Pick-up (Multiple of Current Settings (C))	Delay (Seconds 3 Bands)
2000	800	200, 400, 800	0.5, 0.6, 0.7, 0.8, 0.9, 0.95 and 1.0	2.4, 4.9, 9.8, 20	1.5, 2.0, 2.5, 3.0, 4.0, 5.0, 7.0, and 9.0	I ² T in ¹ .10, .21, .35
	1600	800, 1000, 1600				
	2000	2000				
3000	2500, 3000	1000, 2000, 2500, 3000				
4000	4000	4000				I ² T out ² .10, .21, .35

Power+ Trip Unit Characteristics (continued)

Envelope Size	Adjustable Instantaneous Pick-Up without ST (Multiple of Rating Plug Amperes) (X)	Adjustable Instantaneous Pick-Up with ST (Multiple of Rating Plug Amperes) (X)	Ground Fault	
			Pick-Up (Multiple of Sensor Ampere Rating)	Delay ³ (Seconds 3 Bands)
2000	1.5 thru 10.0	1.5 thru 15.0	0.20 thru 0.60	I ² T in ⁴ .10, .21, .35
	1.5 thru 10.0	1.5 thru 15.0	0.20 thru 0.60	
	1.5 thru 10.0	1.5 thru 15.0	0.20 thru 0.60	
3000	1.5 thru 10.0	1.5 thru 13.0	0.20 thru 0.37	I ² T out ² .10, .21, .35
4000	1.5 thru 9.0	1.5 thru 9.0	0.20 thru 0.30	

Enhanced MicroVersaTrip™ Plus and PM Trip Unit Characteristics

Envelope Size	Frame Max. Ampere Rating	Sensor Rating Amperes (S)	Long Time		Short Time	
			Current Setting (C) (Pick-Up) Multiple of Rating Plug Amperes (X)	Delay ² (Seconds)	Pick-up (Multiple of Current Settings (C))	Delay (Seconds)
800	800	200, 400, 800	0.5 thru 1.0 in increments of 0.05	2.4, 4.9, 9.8, 20	1.5 thru 9.0 in increments of 0.5	I ² T in ¹ 0.40
1600	1600	800, 1000, 1600				
2000	2000	2000				
3000	2500	1000, 2000, 2500				
	3000	3000				I ² T out ² .10, .21, .35
4000	4000	4000				

Trip Unit Characteristics (continued)

Envelope Size	Adjustable Instantaneous Pick-Up without ST (Multiple of Rating Plug Amperes) (X)	Adjustable Instantaneous Pick-Up with ST (Multiple of Rating Plug Amperes) (X)	High Range Instantaneous (Multiple of Frame Short-Time Rating) (H)	Ground Fault		
				Pick-Up (Multiple of Sensor Ampere Rating)	Delay With I ² T In Seconds	Delay ³ With I ² T Out Seconds
800	1.5 thru 10.0 in 0.5 increments	1.5 thru 15.0 in 0.5 increments	1.0	0.20 thru 0.60 in increments of 0.01	.44 at 200% of pick-up at lower limit of band	.10, .21, .35
1600	1.5 thru 10.0 in 0.5 increments	1.5 thru 15.0 in 0.5 increments		0.20 thru 0.60 in increments of 0.01		
2000	1.5 thru 10.0 in 0.5 increments	1.5 thru 15.0 in 0.5 increments		0.20 thru 0.60 in increments of 0.01		
3000	1.5 thru 10.0 in 0.5 increments	1.5 thru 13.0 in 0.5 increments		0.20 thru 0.37 in increments of 0.01		
4000	1.5 thru 9.0 in 0.5 increments	1.5 thru 9.0 in 0.5 increments		0.20 thru 0.30 in increments of 0.01		

¹Time delay shown at 600% of current setting at lower limit of band.

²Time delay shown at lower limit of each band. All pick-up tolerances are ± 10%.

³Time delay shown at lower limit of each band. Ground fault pick-up not to exceed 1200 amperes.

⁴Time delay shown at 200% of pick-up at lower limit of band.

S = Sensor amp rating

C = Long-time current setting (pick-up)

H = Short-Time Rating

X = Rating plug amps

Power Break™ II circuit breakers

Trip unit characteristics

Additional Features and Characteristics Exclusive to the Enhanced MicroVersaTrip™ PM Trip Unit ¹

Function	Description	Trip Unit Suffix		
		M (Metering)	P (Relaying)	PM (Metering & Relaying)
Communications	POWER LEADER Communications Bus Link	STD	STD	STD
Amperes (A, kA) ²	Selectable Phase Current ±2.5%	STD	STD	STD
Voltage (V)	L-L or L-N Volts ±1.5%	•		•
Energy (kWh, MWh, GWh)	Total Energy Usage on Brkr ±4%	•		•
Real Power (kW/MW)	L-L or L-N Power ±4%	•		•
Total Power (kVA/MVA)	L-L or L-N Power ±4%	•		•
Frequency (Hz)	Circuit Frequency ± 1Hz	•		•
Demand & Peak Demand (kW)		•		•
Under Voltage Trip	– Adjustable pickup 50-90% – Adjustable delay, 1-15 seconds OFF		•	•
Over Voltage Trip	– Adjustable pickup, 110-150% – Adjustable delay, 1-15 seconds OFF		•	•
Voltage Unbalance	– Adjustable pickup, 10-50% – Adjustable delay, 1-15 seconds OFF		•	•
Current Unbalance	– Adjustable pickup, 10-50% – Adjustable delay, 1-15 seconds OFF		•	•
Power Reversal	– Adjustable pickup, 10-990 kW – Adjustable delay, 1-15 seconds OFF – Power Reversal Direction		• •	• •

¹MicroVersaTrip PM™ functions require 24 Vdc control power.

²Ampere reading also standard on MicroVersaTrip Plus trip units.

Power Break™ II circuit breakers

Power Break™ II nomenclature system

How to Select Power Break™ II

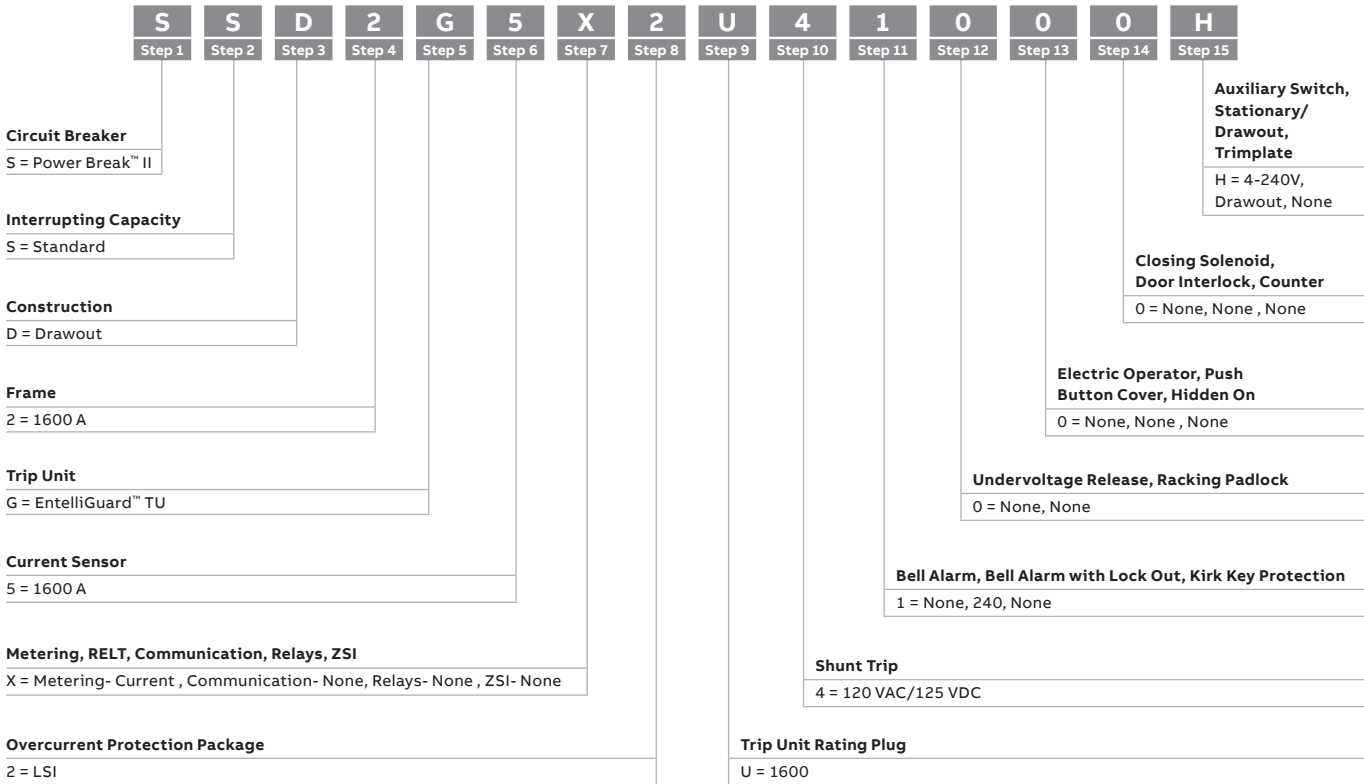

Step 1 Circuit Breaker (Example)

Breaker Type	Character 1
Power Break™ II	S

Step 2 Interrupting Capacity (Example)

Interrupting Type	Character 2
Standard	S
High Break	H

Step 3 Construction (Example)

Construction Type	Character 3
Stationary Front Connected	F
Stationary Back Connected	B
Drawout	D

Step 4 Frame Ratings (Example)

Frame Rating	Character 4
800A	1
1600A	2
2000A	3
2500A	4
3000A	5
4000A	6

Step 5 Trip Unit (Example)

Trip Unit Type	Character 5
Power +	D
Enhanced MVT™	B
Enhanced MVT™ PM	C
EntelliGuard™ TU	G
Switch w/PP	Y

Step 6 Current Sensor (Example)

Sensor Rating	Character 6
200A	1
400A	2
800A	3
1000A	4
1600A	5
2000A	6
2500A	7
3000A	8
4000A	9

Power Break™ II circuit breakers

Power Break™ II nomenclature system

Step 7 Metering, RELT, Communication, Relays, ZSI (Example)

Trip Unit Type + Features	Character 7
POWER +	X
Metering	None
Communication	None
Relays	None
ZSI	None

ENHANCED MVT™	X	A	B
Metering	Current	Current	Current
Communication	None	None	None
Relays	None	None	None
ZSI	None	GF	GF&ST

ENHANCED MVT™ PM	C	D	E	F	G	H	J	K	L
Metering	Current	Current	Current	Full	Full	Full	Full	Full	Full
Communication	COMNET	COMNET	COMNET	COMNET	COMNET	COMNET	COMNET	COMNET	COMNET
Relays	P	P	P	None	None	None	P	P	P
ZSI	None	GF	GF&ST	None	GF	GF&ST	None	GF	GF&ST

ENTELLI GUARD™ TU	X	A	B	C	D	E	F	G	H	J	K	L	M	N
Metering	Current	Current	Current	Current ¹	Full	Full ¹	Full ¹	Full	Full ¹	Current	Current	Current	Current ¹	
RELT	None	RELT	RELT	None ¹	RELT	None ¹	RELT	None ¹	RELT	None ¹	None	RELT	RELT	None ¹
Communication	None	None	Modbus	Modbus ¹	Modbus	Modbus ¹	Modbus	Modbus ¹	Modbus	Modbus ¹	None	None	Modbus	Modbus ¹
Relays	None	None	None	None ¹	None	None ¹	None	None ¹	YES	YES ¹	None	None	None	None ¹
ZSI	None	None	None	None ¹	None	None ¹	None	None ¹	None	None ¹	GF&ST	GF&ST	GF&ST	GF&ST ¹

Trip Unit Type + Features	Character 7 (continued)															
ENTELLI GUARD™ TU	P	Q	R	V	W	Y	Z	1	2	3	4	5	6	7	8	9
Metering	Full	Full ¹	Full ¹	Full	Full ¹	Current ¹	Current ¹	Current ¹	Current ¹	Current ¹	Full ¹	Full ¹	Full ¹	Full ¹	Full ¹	Full ¹
RELT	RELT	None ¹	None ¹	RELT	None ¹	None ¹	None ¹	RELT ¹	RELT ¹	None ¹	RELT ¹	None ¹	None ¹	None ¹	RELT ¹	None ¹
Communication	Modbus	Modbus ¹	Modbus ¹	Modbus	Modbus ¹	None ¹	None ¹	None ¹	Modbus ¹	Modbus ¹	Modbus ¹	Modbus ¹	Modbus ¹	Modbus ¹	Modbus ¹	Modbus ¹
Relays	None	None ¹	None ¹	YES	YES ¹	None ¹	None ¹	None ¹	None ¹	None ¹	None ¹	None ¹	None ¹	None ¹	YES ¹	YES ¹
ZSI	GF&ST	GF&ST ¹	GF&ST ¹	GF&ST	GF&ST ¹	GFST&I ¹	GFST&I ¹	GFST&I ¹	GFST&I ¹	GFST&I ¹	GFST&I ¹	GFST&I ¹	GFST&I ¹	GFST&I ¹	GFST&I ¹	GFST&I ¹

¹Zone Selective Instantaneous Ground Fault & Short Time & Instantaneous (out)

Step 8 Overcurrent Protection Package (Example)

Character 8	Package
X	None (switch)
1	LI
2	LSI ²
3	LSIG ²
4	LSIGA ²
5	LSIGD ²
6	LSH

Character 8	Package
7	LSHG
8	LIG
9	LIGA
A	LIGD
B	LSHGA
C	LSHGD
D	LSIH

²EntelliGuard™ TU Trip Unit only offers these

Power Break™ II circuit breakers

Power Break™ II nomenclature system

Step 9 Trip Unit Rating Plug (Example)

Character 9	EntelliGuard™ TU Trip Unit	MicroVersaTrip™ Plus and Enhanced MicroVersaTrip™ PM Trip Unit	Power +	Rating Plug	Availability by Current Sensor Rating (shaded areas indicate availability)									
					200	400	800	1000	1600	2000	2500	3000	4000	
X				X										
A	•	•	•	100										
B	•	•	•	150		1								
C	•	•	•	200										
D	•	•	•	225										
E	•	•	•	250										
F	•	•	•	300			1							
G	•	•	•	350	2	2	2	2	2	2	2	2	2	2
H	•	•	•	400				1						
I	•	•	•	450										
J	•	•	•	500										
K	•	•	•	600					1					
L	•	•	•	700										
M	•	•	•	750						1				
N	•	•	•	800						1				
O	•	•	•	900	2	2	2	2	2	2	2	2	2	2
P	•	•	•	1000										
Q	•	•	•	1100										
R	•	•	•	1200								1		
S	•	•	•	1250	2	2	2	2	2	2	2	2	2	2
T	•	•	•	1500										
U	•	•	•	1600										
V	•	•	•	1900	2	2	2	2	2	2	2	2	2	2
W	•	•	•	2000										
Y	•	•	•	2200	2	2	2	2	2	2	2	2	2	2
Z	•	•	•	2400	2	2	2	2	2	2	2	2	2	2
1	•	•	•	2500										
2	•	•	•	3000										
3	•	•	•	3200	2	2	2	2	2	2	2	2	2	2
4	•	•	•	3600										
5	•	•	•	4000										

¹Exclusive for MicroVersaTrip™ Plus and Enhanced MicroVersaTrip™ PM Trip Unit Rating Plugs

²Exclusive for EntelliGuard™ TU Trip Unit Rating Plugs only

Step 10 Shunt Trip (Example)

Character 10	Voltage	With Lockout	Without Lockout
0	None		•
1	12Vdc		•
2	24Vac/24Vdc		•
3	48Vac/48Vdc		•
4	120Vac/125Vdc		•
5	208Vac		•
6	240Vac/250Vdc		•
7	480Vac		•
8	600Vac		•
H	12Vdc	•	
J	24Vac/24Vdc	•	
K	48Vac/48Vdc	•	
L	120Vac/125Vdc	•	
M	208Vac	•	
N	240Vac/250Vdc	•	
P	480Vac	•	
R	600Vac	•	

Step 11 Bell Alarm, Bell Alarm With Lockout, Kirk Key Provision (Example)

Character 11	Bell Alarm	Bell Alarm w/Lockout ³	Kirk Key Provision ⁴
0	None	None	None
1	None	240	None
2	None	600	None
4	240	None	None
5	240	240	None
6	240	600	None
8	600	None	None
9	600	240	None
A	600	600	None
G	None	None	4
H	None	240	4
J	None	600	4
L	240	None	4
M	240	240	4
N	240	600	4
R	600	None	4
S	600	240	4
T	600	600	4

³Bell Alarm ratings Vac

⁴Kirk Key Provision number of key locks 1-4

Note: 600Vac module not UL Listed.

Power Break™ II circuit breakers

Power Break™ II nomenclature system

Step 12 UnderVoltage Release, Racking Padlock (Example)

Character 12	UnderVoltage Release	Racking Padlock ¹
0	None	None
1	24Vac	None
2	48Vac	None
3	120Vac	None
4	208Vac	None
5	240Vac	None
6	480Vac	None
7	600Vac	None
8	12Vdc	None
9	24Vdc	None
A	48Vdc	None
B	125Vdc	None
C	250Vdc	None
G	None	All
H	24Vac	All
J	48Vac	All
K	120Vac	All
L	208Vac	All
M	240Vac	All
N	480Vac	All
P	600Vac	All
R	12Vdc	All
S	24Vdc	All
T	48Vdc	All
U	125Vdc	All
V	250Vdc	All

¹Frame Rating

Step 13 Electric Operator, Push Button Cover, Hidden On (Example)

Character 13	Electric Operator	Push Button Cover	Hidden On
0	None	None	None
1	120Vac	None	None
2	240Vac	None	None
3	24Vdc	None	None
4	48Vdc	None	None
5	72Vdc	None	None
6	125Vdc	None	None
8	None	YES	None
9	120Vac	YES	None
A	240Vac	YES	None
B	24Vdc	YES	None
C	48Vdc	YES	None
D	72Vdc	YES	None
E	125Vdc	YES	None
G	None	None	YES
H	120Vac	None	YES
J	240Vac	None	YES
K	24Vdc	None	YES
L	48Vdc	None	YES
M	72Vdc	None	YES
N	125Vdc	None	YES
R	None	YES	YES
S	120Vac	YES	YES
T	240Vac	YES	YES
U	24Vdc	YES	YES
V	48Vdc	YES	YES
W	72Vdc	YES	YES
X	125Vdc	YES	YES

Step 14 Closing Solenoid, Door Interlock, Counter (Example)

Character 14	Closing Solenoid	Door Interlock	Counter
0	None	None	None
1	120Vac	None	None
2	240Vac	None	None
3	24Vdc	None	None
4	48Vdc	None	None
5	72Vdc	None	None
6	125Vdc	None	None
8	None	YES	None
9	120Vac	YES	None
A	240Vac	YES	None
B	24Vdc	YES	None
C	48Vdc	YES	None
D	72Vdc	YES	None
E	125Vdc	YES	None
G	None	None	YES
H	120Vac	None	YES
J	240Vac	None	YES
K	24Vdc	None	YES
L	48Vdc	None	YES
M	72Vdc	None	YES
N	125Vdc	None	YES
R	None	YES	YES
S	120Vac	YES	YES
T	240Vac	YES	YES
U	24Vdc	YES	YES
V	48Vdc	YES	YES
W	72Vdc	YES	YES
X	125Vdc	YES	YES

Step 15 Auxiliary Switch, Stationary/Draw-out, Trimplate (Example)

Character 15	Auxiliary Switch	Stationary/Draw-out	Trimplate
0	None	Stationary	None
1	4-240V	Stationary	None
2	8-240V	Stationary	None
3	12-240V	Stationary	None
4	4-600V	Stationary	None
5	8-600V	Stationary	None
8	None	Stationary	YES
9	4-240V	Stationary	YES
A	8-240V	Stationary	YES
B	12-240V	Stationary	YES
C	4-600V	Stationary	YES
D	8-600V	Stationary	YES
H	4-240V	Drawout	None
J	8-240V	Drawout	None
K	12-240V	Drawout	None
L	4-600V	Drawout	None
M	8-600V	Drawout	None
S	4-240V	Drawout	YES
T	8-240V	Drawout	YES
U	12-240V	Drawout	YES
V	4-600V	Drawout	YES
W	8-600V	Drawout	YES

Power Break™ II circuit breakers

Power Break™ II nomenclature system

Power Break™ II Circuit Breaker Frame Product Numbers

S	S	D	08	*	02	H¹
Power Break™ II Breaker Type						
Current Interrupting Capacity						
S = Standard break						
H = Hi-Break™ breaker						
Construction						
D = Drawout						
F = Stationary, front connected						
B = Back connected, 2500 – 3000 A only						
Frame Rating						
08 = 800 A 25 = 2500 A						
16 = 1600 A 30 = 3000 A						
20 = 2000 A 40 = 4000 A						
Auxiliary Function						
H = High-range instantaneous current sensors						
Blank = Standard current sensors						
Current Sensor Rating						
02 = 200 A 20 = 2000 A						
04 = 400 A 25 = 2500 A						
08 = 800 A 30 = 3000 A						
10 = 1000 A 40 = 4000 A						
16 = 1600 A						
Trip Unit Type and Rating						
B2/D2/G2 = 2000 A maximum						
B3/D3/G3 = 2500 A, 3000 A						
B4/D4/G4 = 4000 A						
Y, W = Insulated case switch						
B for Enhanced MicroVersaTrip™ Plus and MicroVersaTrip™ PM trip unit						
D for Power+™						
G for EntelliGuard trip unit						

¹High-range instantaneous sensors only available on MicroVersaTrip™ Plus and MicroVersaTrip™ PM units.

NOTE: This information is provided only for use interpreting product numbers. It cannot be used to build product numbers.

Accessory Product Numbers

SP	AS	240	AB4D	R
Power Break™ II Breaker Type				
Device Type				
AS = Auxiliary switch ²				
BAA = Bell alarm, alarm only ²				
BAL = Bell alarm with lockout ²				
COUNTER = Mechanical counter ²				
DIL = Defeatable door interlock				
DOSD = Drawout secondary disconnects				
DOWB = Drawout mechanical interlock				
DSS = Substructure shutter kit				
E = Electric operator ²				
HDOS = Hi-Break rated drawout substructure				
K4 = Kirk key lock (4 maximum) ²				
PBCOVER = Pushbutton cover ²				
RCS = Remote close solenoid ²				
SDOD = Standard rated drawout substructure				
ST = Shunt trip ²				
STL = Shunt trip with lockout ²				
UV = Undervoltage release				
WB = Walking beam for stationery breakers				
08 = 800A T-stud				
20 = 1600 thru 2000A T-stud				
S20 = 2000A T-stud (3000 frame)				
S25 = 2500A T-stud				
S30 = 3000A T-stud				
S40 = 4000A T-stud				
RAILS = Rail kit				
LUGA = Lug adapter kit				
B = Enclosure				
Extender				
R = Field installable kit				
Blank = Factory installed				
Auxiliary Switch Extender				
AB4 = Auxiliary switch, type AB with 4 elements				
AB8 = Auxiliary switch, type AB with 8 elements				
AB12 = Auxiliary switch, type AB with 12 elements				
(add suffix "D" for Drawout construction)				
Voltage, unless otherwise stated				
012 = 12 Vdc				
024 = 24 Vdc				
048 = 48 Vdc				
120/125 = 120 Vac or 125 Vdc				
240/250 = 240 Vac and 250 Vdc				
250 = 250 Vdc				
480 = 480 Vac				
600 = 600 Vac				
08 = 800 A 25 = 2500 A				
16 = 1600 A 30 = 3000 A				
20 = 2000 A 40 = 4000 A				
BCA = Back connected aluminum				
BCC = Back connected copper				
FCA = Front connected aluminum terminal T-stud				
FCA = Front connected copper terminal T-stud				
LFCC = Front connected copper, long stud				
36B = 36 secondary disconnects, breaker				
36C = 36 secondary disconnects, substructure				

²Device Product Number requires an extender "R" for field installable kit version only.

NOTE: This information is provided only for use interpreting product numbers. It cannot be used to build product numbers.

Power Break™ II circuit breakers

Product number nomenclature system

EntelliGuard™ TU Trip Unit Product Numbers

	G	B	2	0	4	L	5	C	5	X	R	X	X	X	X	
	Step 1	Step 2	Step 3		Step 4		Step 5	Step 6	Step 7	Step 8	Reserved	Reserved	Reserved	Reserved		
Trip Unit Form Power Break™ II															Reserved	
Frame Ratings 1600A																Reserved
Sensor Rating 400A																Reserved
OC and GF Protection Packages LSIGA (S, switchable) (I, switchable ANSI only)																Reserved
Zone Selective Interlocking ZSI, Short time and GF; user selectable																Original or Replacement Trip Unit Replacement
Advanced Features and Communications Monitoring + Relay Package + RELT																Manual / Auto Trip Reset Not Selected

Step 1 EntelliGuard™ Trip Unit Form

Character 1 & 2	Trip Unit Form
GA	PB1 (UL)
GB	PB2 (UL)

Step 2 Frame Ratings

Character 3	Frame Rating (amperes)	PowerBreak™ I / II
1	800A	•
2	1600A	•
3	2000A	•
4	2500A	•
5	3000A	•
6	3200A	–
7	4000A	•

Step 3 Sensor Rating (Amperes)

Character 4 & 5	Sensor Rating (Amperes)
02	200
04	400
08	800
10	1000
12	1200
14	–
15	–
16	1600
20	2000
25	2500
30	3000

Step 4 OC and GF Protection Packages

Character 6 & 7	Protection	PowerBreak™ I / II
L3	LSI (S, switchable) (I, Non-switchable)	•
L4	LSIG (S, switchable) (I, Non-switchable) (G, Non-Switchable Ground Fault Trip)	•
L5	LSIGA (S, switchable) (I, Non-switchable) (G, Non-Switchable Ground Fault Alarm)	•
L6	LSIC (S, switchable) (I, Non-switchable) (C, Non-Switchable External Ground Fault Trip)	–
L7	LSICA (S, switchable) (I, Non-switchable) (C, Non-Switchable External Ground Fault Alarm)	–
L8	LSIGDA* (S, G, A all switchable) (I, Non-switchable)	•
L9	LSIGCDA* (S, G, C, A all switchable) (I, Non-switchable)	–

NOTE: All options include both the Circuit Break I²T and Fuse I²T curves

Power Break™ II circuit breakers

Product number nomenclature system

Step 5 Zone Selective Interlocking

Character 8	Zone Selective Interlocking	PowerBreak™ II
Z	ZSI, Short time and GF; user selectable	•
T	Z + IOC ZSI; user selectable	• ¹
X	NONE SELECTED	•

¹Instantaneous out only (used as a feeder).

Step 6 Advanced Features and Communications

Character 9	Features and Communications	PowerBreak™ II
1	RELT	•
2	Modbus Protocol + RELT	•
4	Monitoring + RELT	•
5	Monitoring + Relay Package + RELT	•
6	Monitoring + Data Acquisition, Modbus Protocol + RELT	•
X	NONE SELECTED	•
A ²	Modbus Protocol (W/O RELT)	•
B ²	Monitoring (W/O RELT)	•
C ²	Monitoring + Relay Package (W/O RELT)	•
D ²	Monitoring + Data Acquisition, Modbus Protocol (W/O RELT)	•
E ²	Monitoring + Data Acquisition + Relay Package, Modbus (W/O RELT)	•

²Options A - E are only available when output contact is needed for functions other than RELT

Step 7 Manual/Auto Trip Reset

Character 10	Manual/Auto Trip Reset	PowerBreak™ II
X	NONE SELECTED ³	•

³Feature not available for legacy breakers

Step 8 Original or Replacement Trip Unit

Character 11-15	Original or Replacement Trip Unit
RXXXX	Replacement trip unit (shipped loose)

EntelliGuard™ TU Trip Unit Rating Plug Product Numbers

GTP 1100 U 12 25

Trip Unit Type Rating

GTP = Trip unit rating plug
EntelliGuard™ TU Trip Unit

Rating Plug Ampere Rating

0060 = 60 A	1000 = 1000 A
0080 = 80 A	1100 = 1100 A
0100 = 100 A	1200 = 1200 A
0125 = 125 A	1500 = 1500 A
0150 = 150 A	1600 = 1600 A
0200 = 200 A	1700 = 1700 A
0225 = 225 A	1800 = 1800 A
0250 = 250 A	1900 = 1900 A
0300 = 300 A	2000 = 2000 A
0350 = 350 A	2200 = 2200 A
0400 = 400 A	2400 = 2400 A
0450 = 450 A	2500 = 2500 A
0500 = 500 A	3000 = 3000 A
0600 = 600 A	3200 = 3200 A
0700 = 700 A	3600 = 3600 A
0750 = 750 A	4000 = 4000 A
0800 = 800 A	5000 = 5000 A
0900 = 900 A	6000 = 6000 A

Trip Unit Type

U = Universal Trip Plug

Largest Current Sensor Rating

01 = 150 A	16 = 1600 A
02 = 200 A	20 = 2000 A
03 = 225 A	25 = 2500 A
04 = 400 A	30 = 3000 A
06 = 600 A	32 = 3200 A
07 = 630 A	40 = 4000 A
08 = 800 A	50 = 5000 A
10 = 1000 A	60 = 6000 A
12 = 1200 A	64 = 6400 A
13 = 1250 A	

Smallest Current Sensor Rating

01 = 150 A	16 = 1600 A
02 = 200 A	20 = 2000 A
03 = 225 A	25 = 2500 A
04 = 400 A	30 = 3000 A
06 = 600 A	32 = 3200 A
07 = 630 A	40 = 4000 A
08 = 800 A	50 = 5000 A
10 = 1000 A	60 = 6000 A
12 = 1200 A	64 = 6400 A
13 = 1250 A	

Power Break™ II circuit breakers

Product number nomenclature system

Power+ Trip Unit Product Numbers

	D2	20	LSI	T1	R ¹	
Trip Unit Type and Rating	D2 = Power Break™ II Power+ Trip Unit: 2000 A sensor maximum				Replacement or New	
	D3 = Power Break™ II Power+ Trip Unit 3000 A sensor maximum				R = Replacement trip unit	
	D4 = Power Break™ II Power+ Trip Unit: 4000 A sensor maximum				(Blank) = New	
Current Sensor Rating					Trip unit options	
02 = 200 A 20 = 2000 A					T1 = Target Module without ground fault target	
04 = 400 A 25 = 2500 A					T2 = Target Module with ground fault target	
08 = 800 A 30 = 3000 A					(Blank) = Factory Installed	
10 = 1000 A 40 = 4000 A					Auxiliary functions	
16 = 1600 A					LI = Long-time and Instantaneous	
					LSI = Long-time, Short-time, Instantaneous	

¹Device Product Number requires an extender "R" for field installable kit version only.
NOTE: This information is provided only for use interpreting product numbers. It cannot be used to build product numbers.

Power+ Rating Plug Product Numbers

	TR	10	C	800	GF	
Trip Unit Type Rating	TR = Trip unit rating plug All Power+, MicroVersaTrip™ Plus, and MicroVersaTrip™ PM rating plugs				Ground Fault Function	
					Blank = No ground fault	
					GF = Ground fault	
Current Sensor Rating					Rating Plug Ampere Rating	
02 = 200 A 20 = 2000 A					100 = 100 A 800 = 800 A	
04 = 400 A 25 = 2500 A					150 = 150 A 1000 = 1000 A	
08 = 800 A 30 = 3000 A					200 = 200 A 1100 = 1100 A	
10 = 1000 A 40 = 4000 A					225 = 225 A 1200 = 1200 A	
16 = 1600 A					250 = 250 A 1500 = 1500 A	
					300 = 300 A 1600 = 1600 A	
					400 = 400 A 2000 = 2000 A	
					450 = 450 A 2500 = 2500 A	
					500 = 500 A 3000 = 3000 A	
					600 = 600 A 3600 = 3600 A	
					700 = 700 A 4000 = 4000 A	
Trip Unit Type	C = Power+ trip unit rating plugs					

Power+ Target Module Product Numbers
 TARGET00 = Blank insert for Target Module
 TARGET01 = Target Module without ground fault target
 TARGET02 = Target Module with ground fault target

NOTE: This information is provided only for use interpreting product numbers. It cannot be used to build product numbers.

Power Break™ II circuit breakers

Product number nomenclature system

MicroVersaTrip™ Plus and MicroVersaTrip™ PM Trip Unit Product Numbers

B2		20		LSI		GZ1		PM		R ¹	
Trip Unit Type and Rating						Remanufactured					
B2 = Power Break™ II Enhanced MicroVersaTrip Plus™ or PM Trip Unit: 2000 A Sensor maximum						RM = Remanufactured Trip Unit					
B3 = Power Break™ II Enhanced MicroVersaTrip Plus™ or PM Trip Unit: 3000 A Sensor maximum						RX = Exchanged Trip Unit					
B4 = Power Break™ II Enhanced MicroVersaTrip Plus™ or PM Trip Unit: 4000 A Sensor maximum						Trip unit options					
Current Sensor Rating						Options for MicroVersaTrip™ PM trip units only. Must select one:					
02 = 200 A 20 = 2000 A						P = Protective relays & communications					
04 = 400 A 25 = 2500 A						M = Metering & communications					
08 = 800 A 30 = 3000 A						PM = Protective relays, metering, & communications					
10 = 1000 A 40 = 4000 A						(Blank) = MicroVersaTrip™ Plus trip unit					
16 = 1600 A						Ground Fault Functions					
Auxiliary Functions						G = Ground fault					
LI = Long-time and instantaneous						GD = Ground fault defeatable (not UL listed)					
LSI = Long-time, short-time, instantaneous						GZ1 = Ground fault; zone selective interlocking for ground fault only					
LSH = Long-time, short-time, high-range instantaneous						GZ2 = Ground fault and short-time selective interlock					
						GDZ2 = Ground fault defeatable (not UL listed): ground fault and short-time selective interlock					
						(Blank) = None					

¹Device Product Number requires an extender "R" for field installable kit version only.
 NOTE: This information is provided only for use interpreting product numbers. It cannot be used to build product numbers.

Rating Plug Product Numbers (MicroVersaTrip™ Plus and PM)

TR		10		B		800	
Device Type				Rating Plug Ampere Rating			
TR = Trip unit rating plug All MicroVersaTrip™ Plus and MicroVersaTrip™ PM rating plugs				100 = 100 A 1000 = 1000 A			
				150 = 150 A 1200 = 1200 A			
				200 = 200 A 1500 = 1500 A			
				225 = 225 A 1600 = 1600 A			
				300 = 300 A 2000 = 2000 A			
				400 = 400 A 2500 = 2500 A			
				500 = 500 A 3000 = 3000 A			
				600 = 600 A 3600 = 3600 A			
				700 = 700 A 4000 = 4000 A			
				800 = 800 A			
Current Sensor Rating				Trip Unit Type			
2 = 200 A 20 = 2000 A				B = All Enhanced MicroVersaTrip™ Plus and MicroVersaTrip™ PM trip unit rating plugs			
4 = 400 A 25 = 2500 A							
8 = 800 A 30 = 3000 A							
10 = 1000 A 40 = 4000 A							
16 = 1600 A							

NOTE: This information is provided only for use interpreting product numbers. It cannot be used to build product numbers.

Power Break™ II circuit breakers

Interrupting capacity and withstand ratings

The interruption ratings and voltages shown in the table are maximum ratings. A circuit breaker of the type given in the left-hand column may be applied at the given circuit voltage in any electrical distribution system where the available fault current at the load terminals of the breaker does not exceed the value in the table. That circuit breaker type may also be applied at intermediate values of circuit voltage provided the available fault current at the load terminals of the breaker does not exceed the value in the table for the higher value of voltage.

Power Break™ II Interrupting Capacity and Short-time Ratings—rms Symmetrical kA

Frame	800A	1600 to 2000A	2500-3000A	4000A
UL 489 Ratings, 50/60 Hz Standard				
240V	65	85	100	100
480V	65	65	100	100
600V	42	50	85	85
Hi-Break				
240V	100	125	200	200
480V	100	100	150	150
600V	65	65	100	100
Short Time ¹ (0.5 sec)	25	40	42	42
IEC-947-2 Ratings 415, 50/60 Hz				
I_{CU}	—	75	75 ²	85
I_{CS}	—	56	45 ²	25
I_{CW} (1 sec)	—	40	50 ²	50

¹Applies to high range instantaneous or "H" option.

²Must use 4000A construction.

Complete dimensions and weight information can be found in the Power Break™ II application guide GET-8052.

Stationary and Draw-out Switch Withstand Ratings—rms Symmetrical kA

Switch Frame (Amperes)	Short-time Rating, rms Sym Amperes @ 600 Vac Max., 500 ms Max.	Breaker Frame Size (Amperes)	Maximum Short Circuit Withstand Rating When Protected By Power Break™ II Circuit Breakers						Suitable on 200,000 rms Sym Ampere Fault Circuit When Protected by Class L Fuses As Follows	
			Standard Break PB II Circuit Breaker			Hi-Break PB II Circuit Breaker			Line Side Max. Fuse Ampere Rating	Load Side Max. Fuse Ampere Rating
			240 Vac	480 Vac	600 Vac	240 Vac	480 Vac	600 Vac		
800	30	800	65	65	50	100	100	65	2000	800
1600	40	1600	65	65	50	125	100	65	2500	1600
2000	40	2000	65	65	50	125	100	65	2500	2000
2500	42	2500	100	100	85	200	150	100	2500	2500
3000	42	3000	100	100	85	200	150	100	4000	3000
4000	42	4000	100	100	85	200	150	100	4000	4000

Power Break™ II circuit breakers

How to order

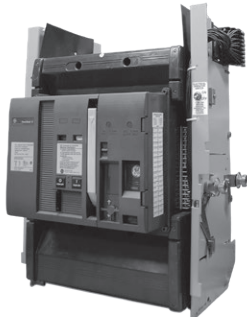

SSF20B220 Frame

How To Order

Power Break™ II's were previously ordered as separate product numbers for the Frame, Trip Unit, Accessories, etc. In 2008, they transitioned to a single 15 digit product number.

1. Determine your 15 digit number by using the BuyLog™ or the digitized configurator.
2. Check Elitenet for price and availability. Note: Because the number of possible combinations is in the millions, only product numbers that have been ordered are in EliteNet. If the number is not available in empower, email the request to load the part to EPIS.USCustomerExcellence@abb.com
3. Once the product number is loaded and pricing finalized, the product can be ordered.
4. Note: Substructures/Cassettes, Neutral CT's, T-Studs, Drawout Secondary disconnects are ordered separately from the 15 digit number.

Example—Stationary Breaker SSF3G6H2N001130

2000 ampere stationary frame, 65 kA, 480 V IC rating, 2000 ampere sensor, 800 ampere rating plug, trip unit functions including long-time (L), short-time (S), Instantaneous (I), EntelliGuard™ TU trip unit, factory installed 120 Vac electric (motor) operator, 24 Vdc remote close solenoid, 24 Vdc undervoltage release module.

Note: See Power Break™ II Price Configurator, your ABB Sales Representative, or call 1-800-GE1-STOP for pricing or any other information.

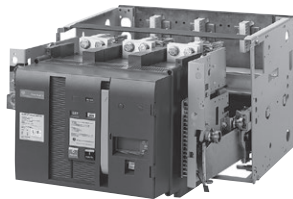

Draw-out in Substructure

Example—Draw-out Breaker SHD2G4X2K200130

1600 ampere draw-out frame, 100 kA, 480 V IC rating, 1000 ampere sensor, 600 ampere rating plug, trip unit functions including longtime (L), short-time (S), instantaneous (I), EntelliGuard™ TU trip unit, factory installed accessories including: 120 Vac electric (motor) operator; 24 Vdc remote close solenoid; 24 Vdc shunt trip.

Note: See Power Break™ II Price Configurator, your ABB Sales Representative, or call 1-800-GE1-STOP for pricing or any other information.

Description	Product Number
Drawout Substructure	SPHDOS16
Substructure Secondary Disconnect	SPDOSD36S
Substructure Shutter Kit	SPDSS20

Power Break™ II circuit breakers

Trip unit selection

How To Order

1. Determine the basic trip unit product number.
2. Select the trip unit suffix representing the protection function to complete trip unit product number.
3. Order rating plug separately.
4. For replacement trip units, replace “F” with “R”. Check empower for List Price and GO schedule.

Example:

1600 Ampere frame, 1000 ampere sensor, Long-time (L). Short-time (S), Instantaneous (I), RELT, Modbus Communications, EntelliGuard™ with Advanced metering GB210L3X6FXXXX. The replacement trip unit product number would be GB210L3X6RXXXX. Rating Plug GTP1000U1025.

Power Break™ II Trip Unit Suffix Power+ Trip Unit Suffix Selection

Trip Unit Suffix ¹	Trip Indicators		Long-Time (L)	Short-Time (ST)	Inst. (I)
Adjustable Instantaneous	L/ST/I ¹	GF ²			
LI	-	-	•	-	•
LIT	•	-	•	-	•
LIT2	•	•	•	-	•
LSI	-	-	•	•	•
LSIT1	•	-	•	•	•
LSIT2	•	•	•	•	•

¹For high-range instantaneous or zone selective interlocking select MicroVersaTrip™ Plus or PM trip units.

²For ground fault-protection, select appropriate rating plug.

Basic Trip Unit Selection

Frame Size (Amperes)	Frame Rating (Amperes)	Sensor (Amperes)	EntelliGuard™ TU Trip Unit	Power+™ Trip Units	Enhanced MicroVersaTrip™ Plus and MicroVersaTrip™ PM Trip Units
800	800	200	GB102	D202	B202
		400	GB105	D204	B204
		800	GB108	D208	B208
1600-2000	1600	800	GB108	D208	B208
		1000	GB210	D210	B210
		1600	GB316	D216	B216
		2000	GB320	D220	B220
2500-3000	2500	1000	GB310	D210	B210
		2000	GB420	D220	B220
		2500	GB425	D325	B325
		3000	GB530	D330	B330
4000	4000	4000	GB740	D440	B440

EntelliGuard™ TU with Selectable Phase Ammeter - Trip Indicators Standard

Suffix 1 ¹	Overcurrent Protections	Trip Indicators	Selectable Phase Ammeter	Long-Time (L)	Long-Time with Fuse Settings (J)	Switchable Short-Time (ST)	Inst (I)	Ground Fault (G)	Ground Fault Alarm (GA)	GF/ST Zone Interlock (ZSI) ³
L3**	LSI (S, switchable)	•	•	•		•	•			opt.
L4**	LSIG (S, switchable)	•	•	•		•	•	•	•	opt.
L5**	LSIGA (S, switchable)	•	•	•		•	•		•	opt.
L8**	LSIGDA (GF/S, switchable) ²	•	•	•		•	•	•	•	opt.

¹Add suffix to basic trip unit to product number.

²Defeatable/Switchable Ground Fault, not UL Listed.

MicroVersaTrip™ Plus with Selectable Phase Ammeter—Trip Indicators Standard

Trip Unit Suffix ³	Trip Indicators	Selectable Phase Ammeter	Long-Time (L)	Short-Time (ST)	Inst (I)	High Inst. (H)	Ground Fault (G) ⁴	GF Zone Interlock (Z1) ⁵	GF/ST Zone Interlock (Z2) ⁵
Adjustable Instantaneous									
LI	•	•	•		•				
LIG	•	•	•		•		•		
LIG Z1	•	•	•		•		•	•	
LSI	•	•	•	•	•				
LSIG	•	•	•	•	•		•		
LSIGZ1	•	•	•	•	•		•	•	
LSIGZ2	•	•	•	•	•		•		•
Fixed High Range Instantaneous⁴									
LSH	•	•	•	•	•	•			
LSHG	•	•	•	•	•	•	•		
LSHGZ1	•	•	•	•	•	•	•	•	
LSHGZ2	•	•	•	•	•	•	•		•

¹Add suffix to basic trip unit product number.

²For single-phase 3 wire or 3-phase, 4-wire applications, order appropriate neutral current sensor separately, page 8-180. Defeatable Ground Fault (not UL Listed) is available. Use code GD in place of G.

³Requires purchase of Zone Selective Interlock module(s) Type TIM1 (120 Vac control voltage).

⁴Not available on 4000A stationary breaker frame.

Power Break™ II circuit breakers

Trip unit selection

MicroVersaTrip™ PM with Metering and Communications—Trip Indicators Standard

Trip Unit Suffix ¹	Trip Indicators	Selectable Phase Ammeter	Long-Time (L)	Short-Time (ST)	Inst (I)	High Inst. (H)	Ground Fault (G) ²	GF Zone Interlock (Z1) ³	GF/ST Zone Interlock (Z2) ³
Adjustable Instantaneous									
LIM	•	•	•		•				
LIGM	•	•	•		•		•		
LIGZ1M	•	•	•		•		•	•	
LSIM	•	•	•	•	•				
LSIGM	•	•	•	•	•		•		
LSIGZ1M	•	•	•	•	•		•	•	
LSIGZ2M	•	•	•	•	•		•		•
Fixed High Range Instantaneous⁴									
LSHM	•	•	•	•		•			
LSHGM	•	•	•	•		•	•		
LSHGZ1M	•	•	•	•		•	•	•	
LSHGZ2M	•	•	•	•		•	•		•

MicroVersaTrip™ PM with Protective Relays and Communications—Trip Indicators Standard

Trip Unit Suffix ¹	Trip Indicators	Selectable Phase Ammeter	Long-Time (L)	Short-Time (ST)	Inst (I)	High Inst. (H)	Ground Fault (G) ²	GF Zone Interlock (Z1) ³	GF/ST Zone Interlock (Z2) ³
Adjustable Instantaneous									
LIP	•	•	•		•				
LIGP	•	•	•		•		•		
LIGZ1P	•	•	•		•		•	•	
LSIP	•	•	•	•	•				
LSIGP	•	•	•	•	•		•		
LSIGZ1P	•	•	•	•	•		•	•	
LSIGZ2P	•	•	•	•	•		•		•
Fixed High Range Instantaneous⁴									
LSHP	•	•	•	•		•			
LSHGP	•	•	•	•		•	•		
LSHGZ1P	•	•	•	•		•	•	•	
LSHGZ2P	•	•	•	•		•	•		•

MicroVersaTrip™ PM with Metering, Protective Relays and Communications—Trip Indicators Standard

Trip Unit Suffix ¹	Trip Indicators	Selectable Phase Ammeter	Long-Time (L)	Short-Time (ST)	Inst (I)	High Inst. (H)	Ground Fault (G) ²	GF Zone Interlock (Z1) ³	GF/ST Zone Interlock (Z2) ³
Adjustable Instantaneous									
LIPM	•	•	•		•				
LIGPM	•	•	•		•		•		
LIGZ1PM	•	•	•		•		•	•	
LSIPM	•	•	•	•	•				
LSIGPM	•	•	•	•	•		•		
LSIGZ1PM	•	•	•	•	•		•	•	
LSIGZ2PM	•	•	•	•	•		•		•
Fixed High Range Instantaneous⁴									
LSHPM	•	•	•	•		•			
LSHGPM	•	•	•	•		•	•		
LSHGZ1PM	•	•	•	•		•	•	•	
LSHGZ2PM	•	•	•	•		•	•		•

¹Add suffix to basic trip unit product number.

²For single-phase 3 wire or 3-phase, 4-wire applications, order appropriate neutral current sensor separately, page 8-180. Defeatable Ground Fault (not UL Listed) is available. Use code GD in place of G.

³Requires purchase of Zone Selective Interlock module(s) Type TIM1 (120 Vac control voltage).

⁴Not available on 4000A stationary breaker frame.

Power Break™ II circuit breakers

Enhanced MicroVersaTrip™, rating plug selection



MicroVersaTrip™ and MicroVersaTrip™ PM Rating Plug



Power+ Trip Target Module



EntelliGuard™ TU Rating Plug

Power Break™ II Rating Plug Selection

Frame Size (Amperes)	Sensor Rating (Amperes)	Current Rating (Amperes)	Power+ Trip Unit Standard Rating Plugs	Power+ Trip Unit Ground Fault Rating Plugs	Enhanced MicroVersaTrip™ Plus and Enhanced MicroVersaTrip™ PM Trip Unit Rating Plugs	EntelliGuard™ TU Trip Unit Rating Plugs	
800	200	100	TR2C100	TR2C100GF	TR2B100	GTP0100U0103	
		150	TR2C150	TR2C150GF	TR2B150	GTP0150U0104	
		200	TR2C200	TR2C200GF	TR2B200	GTP0200U0204	
	400	400	150	-	-	TR4B150	GTP0150U0104
			200	TR4C200	TR4C200GF	TR4B200	GTP0200U0204
			225	TR4C225	TR4C225GF	TR4B225	GTP0225U0306
			250	TR4C250	TR4C250GF	TR4B250	GTP0250U0407
300			TR4C300	TR4C300GF	TR4B300	GTP0300U0408	
400			TR4C400	TR4C400GF	TR4B400	GTP0400U0410	
300			-	-	TR8B300	GTP0300U0408	
800-1600	800	400	TR8C400	TR8C400GF	TR8B400	GTP0400U0410	
		450	TR8C450	TR8C450GF	TR8B450	GTP0450U0612	
		500	TR8C500	TR8C500GF	TR8B500	GTP0500U0613	
		600	TR8C600	TR8C600GF	TR8B600	GTP0600U0616	
		700	TR8C700	TR8C700GF	TR8B700	GTP0700U0816	
		800	TR8C800	TR8C800GF	TR8B800	GTP0800U0820	
		400	-	-	TR10B400	GTP0400U0410	
		600	TR10C600	TR10C600GF	TR10B600	GTP0600U0616	
		800	TR10C800	TR10C800GF	TR10B800	GTP0800U0820	
		1000	TR10C1000	TR10C1000GF	TR10B1000	GTP1000U1025	
1600	1600	600	-	-	TR16B600	GTP0600U0616	
		800	TR16C800	TR16C800GF	TR16B800	GTP0800U0820	
		1000	TR16C1000	TR16C1000GF	TR16B1000	GTP1000U1025	
		1100	TR16C1100	TR16C1100GF	TR16B1100	GTP1100U1225	
		1200	TR16C1200	TR16C1200GF	TR16B1200	GTP1200U1232	
		1600	TR16C1600	TR16C1600GF	TR16B1600	GTP1600U1640	
2000	2000	750	-	-	TR20B750	GTP0750U0820	
		800	-	-	TR20B800	GTP0800U0820	
		1000	TR20C1000	TR20C1000GF	TR20B1000	GTP1000U1025	
		1200	TR20C1200	TR20C1200GF	TR20B1200	GTP1200U1232	
		1500	TR20C1500	TR20C1500GF	TR20B1500	GTP1500U1640	
		1600	TR20C1600	TR20C1600GF	TR20B1600	GTP1600U1640	
		2000	TR20C2000	TR20C2000GF	TR20B2000	GTP2000U2050	
		400	-	-	TR10B400	GTP0400U0410	
		600	TR10C600	TR10C600GF	TR10B600	GTP0600U0616	
		800	TR10C800	TR10C800GF	TR10B800	GTP0800U0820	
2500	2000	1000	TR10C1000	TR10C1000GF	TR10B1000	GTP1000U1025	
		750	-	-	TR20B750	GTP0750U0820	
		800	-	-	TR20B800	GTP0800U0820	
		1000	TR20C1000	TR20C1000GF	TR20B1000	GTP1000U1025	
		1200	TR20C1200	TR20C1200GF	TR20B1200	GTP1200U1232	
		1500	TR20C1500	TR20C1500GF	TR20B1500	GTP1500U1640	
		1600	TR20C1600	TR20C1600GF	TR20B1600	GTP1600U1640	
		2000	TR20C2000	TR20C2000GF	TR20B2000	GTP2000U2050	
		1600	TR25C1600	TR25C1600GF	TR25B1600	GTP1600U1640	
		3000	2500	2000	TR25C2000	TR25C2000GF	TR25B2000
2500	TR25C2500			TR25C2500GF	TR25B2500	GTP2500U2564	
1200	TR30C1200			TR30C1200GF	TR30B1200	GTP1200U1232	
1600	TR30C1600			TR30C1600GF	TR30B1600	GTP1600U1640	
2000	TR30C2000			TR30C2000GF	TR30B2000	GTP2000U2050	
2500	TR30C2500			TR30C2500GF	TR30B2500	GTP2500U2564	
4000	3000	3000	TR30C3000	TR30C3000GF	TR30B3000	GTP3000U3064	
		1600	TR40C1600	TR40C1600GF	TR40B1600	GTP1600U1640	
		2000	TR40C2000	TR40C2000GF	TR40B2000	GTP2000U2050	
		2500	TR40C2500	TR40C2500GF	TR40B2500	GTP2500U2564	
		3000	TR40C3000	TR40C3000GF	TR40B3000	GTP3000U3064	
4000	4000	3600	TR40C3600	TR40C3600GF	TR40B3600	GTP3600U4064	
		4000	TR40C4000	TR40C4000GF	TR40B4000	GTP4000U4064	

Power+ Target Module

Power+ trip units are designed to accept an optional field-installable target module. The target module indicates long-time pickup, battery status, trip unit health status, and whether a breaker trip was caused by an overload, a short circuit or a ground fault. Target modules are available with or without ground fault indication.

Trip Indicator		Product Number
L/ST/1	Ground Fault	
-	-	TARGET00
•	•	TARGET01
•	•	TARGET02

Power Break™ II molded case switch

Old product numbers — stationary and draw-out switch selection

How To Order

1. Choose a frame from the Molded Case Switch Frame tables below
2. Select a Control Unit from the Control Unit table below. The sensor rating of the control unit should match the sensor rating of the switch. Choose a control unit with suffix T2 to get ground fault target indication.
3. Select a rating plug from the table to the right.
4. Select all other accessories just as for any Power Break™ II Circuit Breaker.

Power Break™ II Rating Plug Selection

Basic Control Unit	Current Rating (Amperes)	Power + Standard Rating Plug	Power + Ground Fault Rating Plug
D208	800	TR8C800	TR8C800GF
D210	1000	TR10C1000	TR10C1000GF
D216	1600	TR16C1600	TR16C1600GF
D220	2000	TR20C2000	TR20C2000GF
D325	2500	TR25C2500	TR25C2500GF
D330	3000	TR30C3000	TR30C3000GF
D440	4000	TR40C4000	TR40C4000GF

Molded Case Switch Frames—Stationary

Switch Envelope Size (Amperes)	Switch Frame Size (Amperes)	Current Sensor Rating (Amperes)	Product Number
800	800	800	SSF08Y208
1600	1600	1600	SSF16Y216
2000	2000	2000	SSF20Y220
3000	2500	2500	SSF25Y325 SSB25Y325
	3000	3000	SSF30Y330 SSB30Y330

Ordering Example SSD2Y4A2H200220

1600 ampere drawout switch; factory installed 240 Vac electric (motor) operator; 240 Vac remote close solenoid; 24 Vac/DC shunt trip; drawout substructure; drawout secondary disconnect; drawout shutter.

Note: See Power Break™ II updated nomenclature on page 8-157 for product number and see Power Break™ II configurator for pricing. Contact sales representative for configurator.

Molded Case Switch Frames—Draw-out¹

Switch Envelope Size (Amperes)	Switch Frame Size (Amperes)	Current Sensor Rating (Amperes)	Product Number
800	800	800	SSD08Y208
1600	1600	1600	SSD16Y216
2000	2000	2000	SSD20Y220
3000	2500	2500	SSD25Y325
	3000	3000	SSD30Y330
4000	4000	4000	SSD40Y440

¹Use only with Hi-Break draw-out substructure.

Control Units

Switch Envelope Size (Amperes)	Switch Frame Size (Amperes)	Sensor (Amperes)	Product Number
800	800	800	D208
			D208T2
1600	1600	1000	D210
			D210T2
		1600	D216
			D216T2
2000	2000	2000	D220
			D220T2
3000	2500	1000	D210
			D210T2
		2000	D220
			D220T2
	2500	2500	D325
			D325T2
3000	3000	3000	D330
			D330T2
4000	4000	4000	D440
			D440T2

Power Break II circuit breakers

Stationary and draw-out breaker accessories

All devices UL Listed for factory or field installation except where noted.

Accessories—Stationary and Draw-out Breakers

The complete line of Power Break™ II breaker accessories may be either factory or field installed to meet user needs. The electronic shunt trip, the bell alarm, the bell alarm with mechanical lockout, and the undervoltage release modules are drop-in from the front of the breaker, interchangeable across all frames, and require no field internal wiring or breaker disassembly. Auxiliary switch modules are available in groups of 4, 8 or 12, NO/NC single-pole, double-throw (SPDT) switches. Their installation simply involves removal of breaker cover, installation of the switch module, routing of wiring and installation of the pre-wired terminal block and re-installation of the cover. Auxiliary switches are also interchangeable across all Power Break™ II breaker frames.

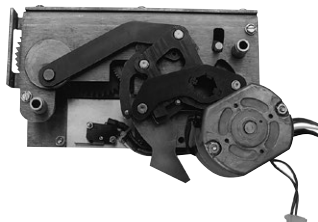

Electrical Operator

Electrical Operator

The electrical operator mounts inside the front cover of the manually operated breaker. This accessory can be added to any Power Break™ II breaker in the factory or the field to provide electrical spring charging and charge indication. **For remote closing, the remote close solenoid must be ordered separately.** All breakers are prewired to dedicated secondary terminals for easy field installation. When electrical operation is used, either a shunt trip or an undervoltage release must be ordered separately.

Ratings Vac	Ratings Vdc	Field Installable Product Number	Factory Installed Product Number
120	–	SPE120R	SPE120
240	–	SPE240R	SPE240
–	24	SPE024R	SPE024
–	48	SPE048R	SPE048
–	72	SPE072R	SPE072
–	125	SPE125R	SPE125

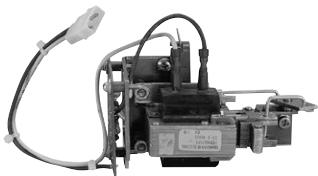

Remote Close Solenoid

Remote Close Solenoid

This accessory provides an electrically operated solenoid which, when energized, closes the breaker. It is suitable for control interlock schemes in which manual closing capability would not be convenient or desirable. The breaker is provided with a manual close button, which can be replaced by the Hidden "ON" Button accessory and/or sealed using the Limited Access Pushbutton Cover accessory. The remote close accessory is continuously rated and has an anti-pump feature, which prevents a motor operated breaker from repeatedly closing into a fault. Closing control voltage must be removed and re-applied for each breaker closure.

Ratings Vac	Ratings Vdc	Field Installable Product Number	Factory Installed Product Number
120	–	SPRCS120R	SPRCS120
240	–	SPRCS240R	SPRCS240
–	24	SPRCS024R	SPRCS024
–	48	SPRCS048R	SPRCS048
–	72	SPRCS072R	SPRCS072
–	125	SPRCS125R	SPRCS125

Power Break II circuit breakers

Stationary and draw-out breaker accessories

All devices UL Listed for factory or field installation except where noted.



Shunt Trip Module

Shunt Trip

The shunt trip accessory is an electronic module, which provides remote control capability to open the circuit breaker. When activated, the shunt trip module sends a signal to the trip unit to open the breaker. This allows the trip unit to record, display, distinguish and communicate (in MicroVersaTrip™ PM trip units) that the opening event was initiated by the shunt trip device. The shunt trip is continuously rated and requires no cut-off switch. When energized, the shunt trip supplies +24Vdc power to the trip unit to power the display.

Ratings Vac	Ratings Vdc	Field Installable Product Number	Factory Installed Product Number
–	12	SPST012R	SPST012
24	24	SPST024R	SPST024
48	48	SPST048R	SPST048
120	125	SPST120R	SPST120
208	–	SPST208R	SPST208
240	250	SPST240R	SPST240
480	–	SPST480R ¹	SPST480 ¹
600	–	SPST600R ¹	SPST600 ¹

¹Kit contains externally mounted transformer.

Shunt Trip with Lockout Module

The shunt trip with lockout is identical to the regular shunt trip, but when energized, it will also prevent closure of an "open" breaker by mechanically blocking both manual and electrical closing. When energized, the closing springs will not discharge, the movable contacts will not move; the contacts are "kiss free."

Ratings Vac	Ratings Vdc	Field Installable Product Number	Factory Installed Product Number
–	12	SPSTL012R	SPSTL012
24	24	SPSTL024R	SPSTL024
48	48	SPSTL048R	SPSTL048
120	125	SPSTL120R	SPSTL120
208	–	SPSTL208R	SPSTL208
240	250	SPSTL240R	SPSTL240
480	–	SPSTL480R ¹	SPSTL480
600	–	SPSTL600R ¹	SPSTL600

¹Kit contains externally mounted transformer.

Power Break II circuit breakers

Stationary and draw-out breaker accessories

All devices UL Listed for factory or field installation except where noted.



Undervoltage Release Module

Undervoltage Release Module

The undervoltage release is an electronic module used to open the circuit breaker when the monitored voltage drops below 35-60% of its rated value. The undervoltage release "resets" when the monitored voltage is re-established allowing the circuit breaker to reclose (the sealing voltage of the UVR is 60-85% of its rated voltage).

An undervoltage release trip operation is produced by the MicroVersaTrip™ Plus unit in response to a signal from the undervoltage release module. This allows the trip unit to record, display, distinguish and communicate (in MicroVersaTrip™ PM trip units) that the breaker opening event was due to undervoltage release. Operation of the undervoltage release module will prevent breaker contact closure, i.e. "kiss-free" operation. When energized, the undervoltage release supplies +24 Vdc power to the trip unit to power the display.

Ratings Vac	Ratings Vdc	Field Installable Product Number	Factory Installed Product Number
24	-	SPUV024ACR	SPUV024AC
48	-	SPUV048ACR	SPUV048AC
120	-	SPUV120ACR	SPUV120AC
208	-	SPUV208ACR	SPUV208AC
240	-	SPUV240ACR	SPUV240AC
480	-	SPUV480ACR ¹	SPUV480AC ¹
600	-	SPUV600ACR ¹	SPUV600AC ¹
-	12	SPUV012DCR	SPUV012DC
-	24	SPUV024DCR	SPUV024DC
-	48	SPUV048DCR	SPUV048DC
-	125	SPUV125DCR	SPUV125DC
-	250	SPUV250DCR	SPUV250DC

¹Kit contains externally mounted transformer.

Time Delay Module for UVR

The time delay module prevents nuisance tripping due to momentary loss of voltage. The module has 120 Vac input and 125 Vdc output and must be used with the 125 Vdc UVR.

Description	Product Number
Time Delay Module (0.1 to 1.0 second delay)	SPUVTD



Bell Alarm (Alarm Only)

Bell Alarm (Alarm Only)

The bell alarm module is used to signal breaker "tripped" status to other accessories (e.g., external alarm devices, indicating lights, relays, or logic circuits) for remote indication and interlocking functions. The bell alarm response is configurable by means of rear-mounted DIP switches on the trip unit. The bell alarm can be made to operate in response to an overcurrent (including ground fault) or protective relay trip and/or a shunt trip operation, and/or operation of the undervoltage release module. It is not actuated as a result of normal breaker "ON/OFF" operation. This module provides a visual, mechanical pop-out target, which protrudes through the face of the circuit breaker door when it operates. The bell alarm may be reset manually by depressing the mechanical target, or automatically by closing the breaker. The bell alarm is provided with one SPDT switch with control power duty contacts as shown in the auxiliary switch accessories.

Ratings Vac	Ratings Vdc	Field Installable Product Number	Factory Installed Product Number
240	125-250	SPBAA240R	SPBAA240
600	125-250	SPBAA600R ¹	SPBAA600 ¹

¹600 Vac module not UL Listed.

Power Break II circuit breakers

Stationary and draw-out breaker accessories

All devices UL Listed for factory or field installation except where noted.



Bell Alarm with Mechanical Reset Lockout

Bell Alarm With Lockout

The bell alarm with lockout module combines both the bell alarm and a manual lockout function. The bell alarm switch operates identically to the standard bell alarm module, except that the mechanical pop-out target must be manually reset before the breaker can be closed.

Operation of the bell alarm with lockout module can be independently set by means of setting the DIP switches at the rear of the trip unit. Current rating of the single SPDT switch is identical to the auxiliary switch accessories.

Ratings Vac	Ratings Vdc	Field Installable Product Number	Factory Installed Product Number
240	125-250	SPBAL240R	SPBAL240
600	125-250	SPBAL600R ¹	SPBAL600 ¹

¹600 Vac module not UL Listed.



Auxiliary Switch with Pre-wired Secondary Terminals for Stationary Breaker

Auxiliary Switch

An auxiliary switch signals the circuit breaker's primary contact position (i.e., OPEN or CLOSED) to other devices, such as indicating lights, relays or logic circuits. This enables the user to provide remote indication, interlocking or control operations as a function of breaker primary contact position. The auxiliary switch operation is independent of the method by which the breaker is opened or closed. The auxiliary switch does not distinguish between a "tripped" or "open" condition. The auxiliary switch contacts follow the main breaker contacts on opening and precede them on closing.

Auxiliary switch modules are available with 4, 8 or 12 NO/NC (SPDT) switches for control power duty ac/dc ratings. When ordered for field installation, an auxiliary switch module comes pre-wired to its own terminal board, which mounts with one screw to the left of the breaker. A special accessory, available for draw out breakers, comes pre-wired to the breaker secondary disconnect. All switch ratings are 6A at 120V-600 Vac, 1/2A at 125 Vdc and 1/4A at 250 Vdc.

Auxiliary Switches for Stationary Breakers

Ratings Vac	Ratings Vdc	No. of SPDT Switch Elements (Contacts)	Field Installable Product Number	Factory Installed Product Number
240	125-250	4	SPAS240AB4R	SPAS240AB4
240	125-250	8	SPAS240AB8R	SPAS240AB8
240	125-250	12	SPAS240AB12R	SPAS240AB12
600	125-250	4	SPAS600AB4R ¹	SPAS600AB4 ¹
600	125-250	8	SPAS600AB8R ¹	SPAS600AB8 ¹

¹600 Vac module not UL Listed.



Auxiliary Switch with Pre-wired Secondary Terminals for Draw-out Breaker

Auxiliary Switches for Draw-out Breakers

Ratings Vac	Ratings Vdc	No. of SPDT Switch Elements (Contacts)	Field Installable Product Number	Factory Installed Product Number
240	125-250	4	SPAS240AB4DR	SPAS240AB4D
240	125-250	8	SPAS240AB8DR	SPAS240AB8D
240	125-250	12	SPAS240AB12DR	SPAS240AB12D
600	125-250	4	SPAS600AB4DR ¹	SPAS600AB4D ¹
600	125-250	8	SPAS600AB8DR ¹	SPAS600AB8D ¹

¹600 Vac module not UL Listed.

Power Break II circuit breakers

Stationary and draw-out breaker accessories

All devices UL Listed for factory or field installation except where noted.



Mechanical Operations Counter

Mechanical Operations Counter

The mechanical operations counter is mounted behind the front cover of the breaker. It is viewable through a rectangular knockout window opening in the breaker cover. It is a five-digit, non-resettable counter, which is actuated each time the breaker is opened by any means.

Field Installable Product Number	Factory Installed Product Number
SPCOUNTERR	SPCOUNTER



Breaker with limited access pushbutton cover assembly installed

Limited Access Pushbutton Cover

This accessory limits access to "ON/OFF" control of a breaker to authorized personnel. The pushbutton cover accessory consists of transparent hinged covers that can be individually sealed to the limited access assembly. Both the "ON" and "OFF" buttons can be pilot drilled to allow use of a 1/8" rod to operate either one or both pushbuttons.

Field Installable Product Number	Factory Installed Product Number
SPPBCOVERR	SPPBCOVER



Activating the breaker closing mechanism through the hole in the Hidden "ON" Button

Hidden "ON" Button

The hidden "ON" button is assembled to the mechanism behind an unlabeled, false pushbutton. Manual closing of the breaker can only be performed by means of a small diameter rod. This accessory is used to limit access to the manual "ON" control to authorized personnel.

Field Installable Product Number	Factory Installed Product Number
SPPBNONR	SPPBNON

Maintenance/Repair Parts

Description	Product Number
Top Cover and Rating Labels	SPBIICOVER ¹
Replacement MVT Door	10054335P1
Replacement Powerplus Door	10054335P2
Stop Block Kit w/Installation Tool	SPBUMPERKIT
Visible "On" Button Conversion	SPPBRONR
PB1 SM FR Door Interlock/Padlock	TSPL
800A PB1 to PB2 Stationary Retrofit Kit	SSF08TPCCR ²
1600A PB1 to PB2 Stationary Retrofit Kit	SSF16TPCCR ²
2000A PB1 to PB2 Stationary Retrofit Kit	SSF20TPCCR ²
2500A-4000A PB1 to PB2 Stationary Retrofit Kit	SSF40TPCCMR ³
2500A-4000A PB1 to PB2 Stationary Retrofit Kit	SSF40TPCCER ⁴
Replacement Breaker Secondary Disconnect	SPDOSD36B

¹Special handling and order entry required to preserve UL Listing of breaker. Contact Post Sale Service for additional details of special process.

²Manually or electrically operated

³Manually operated

⁴Electrically Operated

Power Break II circuit breakers

Stationary and draw-out breaker accessories

All devices UL Listed for factory or field installation except where noted.

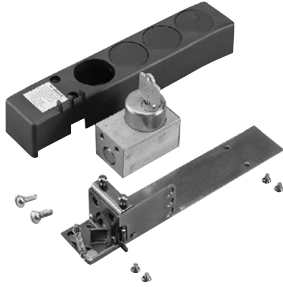

Key Interlock Kit (lock not included)

Key Interlock Provisions

The key interlock provision enables the user to mount a one- to four-cylinder, narrowfaced, Kirk-type FN or Superior customer-supplied lock on the face of the breaker. This accessory provides mounting for key interlocks that are furnished by the customer. The key interlock provision works in conjunction with the padlock provision. The key interlock extends a lever through the padlock hasp when the key is turned to the key removal or bolt extended position. Additionally, the accessory provides a hasp for mounting three padlocks with 1/4" to 3/8" diameter shanks.

Key Interlock Reference Table

Product Number	Number of Locks	Kirk Key Lock Product Number	Superior Product Number
SPK4	1	KFN00001 ¹	S105827Y
SPK4	2	KFN00002 ¹	S105828Y
SPK4	3	KFN00003 ¹	S105829Y
SPK4	4	KFN00004 ¹	S105827-4Y

¹Final digit may be 0, 1, 2 or 3 depending on number of key removal positions.

Product Numbers, Key Interlock Provisions

Circuit Breaker Envelope Size (Amps)	Number of Key Locks	Field Installed Product Number	Factory Installed Product Number
All	1 to 4	SPK4R	SPK4

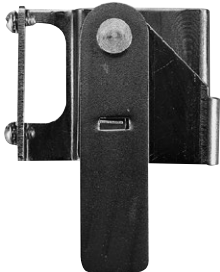

Door Interlock

Door Interlock

The door interlock provides interlocking of the circuit breaker compartment's hinged door so that the breaker must be in the "OFF" position before the door can be opened. The door interlock is defeatable with a small tool to allow authorized access.

Field Installable Product Number	Factory Installed Product Number
SPDILR	SPDIL

Padlock Provisions (Standard)

Padlocking provisions are standard on all Power Break™ II circuit breakers. When the breaker is in the open position, and the padlock hasp is raised at least 1/4", the breaker cannot be closed mechanically or electrically. The hasp accepts up to three padlocks with 1/4" to 3/8" diameter shanks.

Walking Beam Interlocks—Stationary Breakers Only

Walking beam interlocks are mechanical devices used to prevent two adjacent circuit breakers from both being in the "ON" or closed position at the same time. However, both breakers can be in the "OFF" or open position. Adjacent circuit breakers can be laterally or vertically mounted.

Circuit Breaker Envelope Size (Amperes)	Product Number
800, 1600 and 2000	SPWB20
3000	SPWB30
4000	SPWB40

Power Break II circuit breakers

Stationary breaker mounting kits

All devices UL Listed for factory or field installation except where noted.

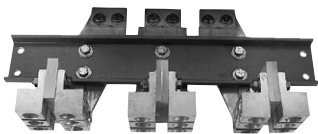

2000 Ampere Power Break™ II breaker with SPLUGA20 lug adapter kit and 18 lugs (TPLUG108)



Type TPLUG206



Type TPLUG408



Type TPLUG308

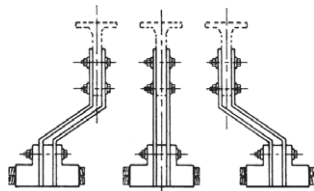

Type TSLUG20

Lug Adapter Kits

Kits pre-mount to bus structure allowing cabling or bussing to be completed prior to breaker mounting. Accepts either lugs or crimp-type connector terminals. Kit includes adapter and hardware for either a three-pole line-side, or a three-pole load-side connection. (Lugs not included).

Frame Rating (Amperes)	Product Number	Suitable for use with up to:
800	TPLUGA08	3 TPLUG108 Lugs or 3 crimp Lugs ¹ per pole
1600	TPLUGA16 ²	6 TPLUG108 lugs or 6 crimp Lugs ¹ per pole
2000	SPLUGA20 ³	6 TPLUG108 Lugs or 6 crimp Lugs ¹ per pole

¹Anderson No. VCEL-075-12H1 or equivalent

²T-Studs - TP16FCA - included with adapter

³T-Studs - SP20FCA - included with adapter

Lug Kits

Kits accept Cu/Al wire and are suitable for direct mounting to the breaker. When ordering Type TPLUG kits, order one kit per line or load pole. Example: A complete set of lugs for the line side of an 800A frame, 400A trip breaker would be Qty 3-TPLUG106 lugs.

When ordering TSLUG kits order one kit per line or load side; TSLUG kits require use of T-studs. Example: A complete set of lugs for a 3000A frame, 2500A trip breaker would be Qty 1-TSLUG25. T-Studs would also be required.

Circuit Breaker Envelope Size (Amperes)	Max Rating (Amperes)	Product Number	Lug Per Kit	Max. Cables Per Pole	Wire Range kcmil Cu/Al
800	400	TPLUG106	1	1	(2) #2 2-600
	600	TPLUG206	1	2	(2) #2 2-600
	800	TPLUG308	1	3	(3) 300-750
	800	TPLUG108 ⁴	1	3	3/0-800
1600	800	TPLUG108 ⁴	1	6	3/0-800
	1600	TPLUG108 ⁴	1	4	3/0-800
2000	2000	TPLUG108 ⁴	1	6	3/0-800
	800	TSLUG08	9	3	3/0-800
3000	1200	TSLUG12	12	4	3/0-800
	1600	TSLUG16	15	5	3/0-800
	2000	TSLUG20	18	6	3/0-800
	2500	TSLUG25	21	7	3/0-800
	3000	TSLUG30	27	9	3/0-800
4000	4000	TSLUG40	27	9	3/0-800

⁴For use with adapter kit only. See table above.

Power Break II circuit breakers

Stationary breaker mounting kits, wall mounted enclosures, floor mounted enclosures

All devices UL Listed for factory or field installation except where noted.

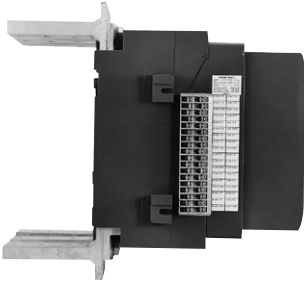

2000A Breaker with "T" Studs Mounted

T-Studs

T-studs mount directly to the breaker, and can be rotated for either vertical or horizontal bus connection. 4000 ampere T-studs are for vertical bus bars only. Product number includes one stud. Both copper and aluminum T-studs are tin-plated.

T-Studs—Front Connected Breaker

Circuit Breaker Frame Size (Amperes)	Max. Rating (Amperes)	Product Number
800	800	SP08FCA ¹
800	800	SP08FCC ²
1600, 2000	2000	SP20FCA ¹
1600, 2000	2000	SP20FCC ²
2500	2000	SPS20FCA ¹
2500	2500	SPS25FCC ²
3000	3000	SPS30FCC ²
4000	4000	SPS40FCC ²
4000	4000	SPS40LFCC ^{2,3}

T-Studs—Back Connected Breaker

Circuit Breaker Frame Size (Amperes)	Max. Rating (Amperes)	Field Installable Product Number
2500	2000	SPS20BCA ^{1,4}
2500	2500	SPS25BCC ²
3000	3000	^{2,4}

¹Aluminum

²Copper

³Extra long stud. Alternate with SPS40FCC for ease of installation.

⁴Supplied with integral T-stud

Trimplate

Factory Installed Product Number	Field Installable Product Number
SPTRIMPLATE	SPTRIMPLATER

Power Break II circuit breakers

Neutral current sensors and POWER LEADER accessories

Neutral Current Sensors¹

Breaker Frame (Amperes)	Circuit Breaker Sensor Rating (Amperes)	Neutral Sensor Rating or Tap Settings (Amperes)	Product Number
800	200	200	TSVG302
	400	400/200	TSVG304A
	400	600/300 ²	TSVG306A
800-1600	800	800/400	TSVG308A
	1000	800/400 ²	TSVG808A
	1000	1000/500	TSVG810A
1600	1600	1200/600 ²	TSVG812A
	1600	1600/1000	TSVG816A
	2000	2000/1000	TSVG820A
2000	1000	800/400 ²	TSVG808A
	1000	1000/500	TSVG810A
	1000	1200/600 ²	TSVG812A
	1000	1600/1000 ²	TSVG816A
3000	2000	2000/1200	TSVG820A
	2500	2500/1800	TSVG825A
	3000	3000/2400	TSVG830A
	4000	4000/3000	TSVG940A

¹Match neutral current sensor rating (or tap setting) to circuit breaker sensor rating.
²For use with multiple source ground fault protection schemes. Rating does not match EntelliGuard™ TU and MicroVersaTrip™ Plus or PM frame sensor.

Neutral Current Sensors¹

Breaker Frame (Amperes)	Circuit Breaker Sensor Rating (Amperes)	Neutral Sensor Rating or Tap Settings (Amperes)	Product Number of Window Sensor	Inside Diameter (inches)
800	800	800/400	SSVG808W	4.25
	1200 ³	2000/1200	SSVG820W	5.63
1200	1600 ³	1600/1000	SSVG816W	5.63
	1600	1600/1000	SSVG816W	5.63
2000	2000	2000/1200 ³	SSVG820W	5.63
2500	2500	2500/1800	SSVG825W	5.63
3000	3000	4000/3000	SSVG940W	6.50
4000	4000	4000/3000	SSVG940W	6.50

¹Match neutral current sensor rating (or tap setting) to circuit breaker sensor rating.
³At time of initial product release, the 1200A new HPC Switch was using 1600A installed sensors and a 1200A rating plug. Later models may or may not use 1200A phase sensors. Match Neutral sensor tap to HPC sensor rating.
³Outline Drawing 10112973P1.

Portable Test Set

The portable, battery-powered test kit provides self-tests and functional trip/no trip tests. It also provides defeat of the ground fault function and can be used in conjunction with high current test equipment. Interface is via a plug on the front of the trip unit and test can be conducted with the breaker in service. Test kits use either 120 Vac power source or internal batteries (not included).

Description	Trip Unit Type	Product Number
Portable Test Set	MicroVersaTrip only	TVRMS2
	EntelliGuard™ TU, microEntelliGuard™ only	GTUTK20

Portable Battery Pack

The hand-held Portable Battery Pack provides an independent power source for EntelliGuard™ TU, microEntelliGuard™, MicroVersaTrip™ Plus and MicroVersaTrip™ PM trip units as an alternative to a test set. The battery pack is used to power up the trip unit to set or adjust trip set points when the breaker is on the bench or otherwise not powered up.

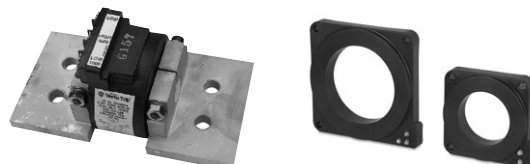

Neutral Current Sensor

SSVG Neutral Current Sensors

For microEntelliGuard™ trip units, the battery pack connects to the trip unit through the 15-pin connector. A battery pack adapter cable is required. For MicroVersaTrip™ Plus and MicroVersaTrip™ PM trip units, the battery pack connects to the trip unit through the rating plug test jack. The battery pack requires three standard 9 Vdc alkaline batteries (not included).

Description	Product Number
Portable Battery Pack	TVPBP
EntelliGuard™ TU, microEntelliGuard™ Battery Pack Adapter Cable	TVPBPACC

POWER LEADER™ Power Supplies

Power supply for furnishing 24Vdc control power for EntelliGuard™ TU, MicroVersaTrip™ Plus and PM trip units.

Description	System Requirements	Product Number
1.5 ampere power supply Price one PLPS4G01 for each line-up. 45 trip units ⁴ and 100 ft. maximum.	Input power, 100VA (85-265Vac or 100-370Vdc)	PLPS4G01

⁴20 trip units maximum for EntelliGuard™ TU

Reference

Instructions	GEH-6492
--------------	----------

POWER LEADER™ Voltage Conditioner

Conditions and scales 120 Vac to 1.76 Vac for use by the trip unit for voltage sensing. Provides transient protection. Voltage conditioners require isolation PTs.

Description	System Requirements	Product Number
Supplies isolated bus voltage signal to EntelliGuard™ TU and MicroVersaTrip™ PM trip units.	One set of 3 voltage conditioners required for each voltage sensing location. PTs also required.	PLVC1G01

Reference

Instructions	GEH-5946
--------------	----------

Rating Plug Removal Tool

Product Number
TRTOOL

Power Break II circuit breakers

Draw-out breaker accessories

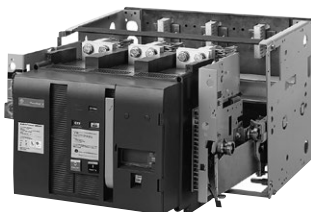

Draw-out Breaker in Substructure

Features

- Draw-outs through 4000 amperes are UL Listed, 100% rated
- Modular design for simplified installation—6 basic sizes—800, 1600, 2000, 2500, 3000, 4000—5 inch pole centers
- Screw racking mechanism provides positive racking motion
- Self aligning primary and secondary disconnects
- Four position draw-out—engaged, test, disengaged, fully withdrawn—simplifies system testing and inspection
- Breaker position indicator clearly shows breaker position
- Provisions for padlocking breaker in test or disengaged position
- Mechanical interlock logic prevents movement of a closed breaker
- Suitable for reverse feeding

Description

The draw-out assembly consists of a substructure housing unit designed as a compact self-supporting unit and a draw-out breaker which must be ordered separately. The substructure contains mounting holes, self-supporting male plugs and extendable rails, and can be ordered separately for installation in your switchboard or enclosure.

The Power Break™ II draw-out breaker is a self-contained, heavy-duty assembly designed to offer simplified breaker inspection without de-energizing the main bus structure.

The draw-out breaker comes complete with racking mechanism drive, wheels, primary and secondary disconnects and cooperating interlock systems.

Accessories such as dead-front shutters, by-pass switches (position switches), and padlock devices are available and field installable.

OEM Substructures

Substructures are available for both standard and Hi-Break Power Break™ II breakers. Holes are provided for bolting on a shelf or supports. Holes are also provided in the primary stabs for bolting to busbars or terminal lugs. Substructure secondary disconnects are ordered and priced separately. Order Hi-Break substructures for use with Power Break™ II switches.

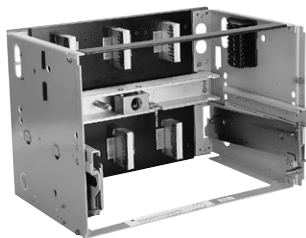

1600-ampere substructure for standard break breaker

Frame Rating (Amperes)	Standard Break Product Number	Hi-Break Product Number
800	SPSDOS08	SPHDOS08
1600	SPSDOS16	SPHDOS16
2000	SPSDOS20	SPHDOS20
2500	SPSDOS25	SPHDOS25
3000	SPSDOS30	SPHDOS30
4000	SPSDOS40	SPHDOS40

Secondary Disconnect for Draw-out Breakers

Control wiring is connected through draw-out secondary disconnects in the "TEST" and "CONNECTED" positions only. Up to 72 control circuits are possible through 36 position plug-style secondary disconnect blocks factory mounted to each side of draw-out breakers. One substructure disconnect (SPDOSD36S) must be ordered for each breaker when accessories or communications are used. When auxiliary switches are used along with any other electrical accessory or communications, two disconnects must be ordered.

Location	Product Number
Substructure	SPDOSD36S
Breaker ¹	SPDOSD36B

¹Order for replacement only. Included and factory wired with draw-out breaker.

Power Break II circuit breakers

Draw-out breakers and accessories

All devices UL Listed for factory or field installation except where noted.

Shutter Kit

This field installable kit provides shutters used to prevent unintentional contact with potentially live primary disconnect stabs when a breaker is racked out of an energized switchboard compartment.

Frame Rating	Product Number
800-2000A	SPDSS20
3000A	SPDSS30
4000A	SPDSS40

By-Pass Switch

Provides positive indication that the draw-out breaker or switch primary contact fingers are fully connected to the main bus in the substructure. Switch contacts change states only after the primary fingers are fully connected when the breaker is being moved from the DISCONNECTED position through the TEST position and into the CONNECTED position.

May be used to provide control circuit continuity or downstream signaling that the draw-out breaker is connected in addition to the visual position indicator on the draw-out substructure. The By-pass switch accessory does not indicate either the TEST or DISCONNECTED position. The switch assembly mounts on the stationary frame and the actuator mounts to the carriage. Switch contacts are rated at 10A at 600 Vac, 0.75A at 125 Vdc, and 0.25A at 250 Vdc.

Number of Switch Elements	Product Number
2 NO/2 NC	TDOBP2L
4 NO/4 NC	TDOBP4L
6 NO/6 NC	TDOBP6L

Racking Padlock Provision

The racking padlock provides a means for the user to prevent racking tool engagement, thereby preventing movement of the breaker between the DISCONNECTED, TEST and CONNECTED positions.

Frame Rating	Product Number
All	TDOPC

Lifting Bar

The lifting bar provides a means of safely lifting a draw-out circuit breaker. A chain hook can be attached to the central hole in the lifting bar or a 1" diameter black iron pipe can be put through the two holes above the hooks, allowing two people to carry the breaker below waist level from either side of the breaker.

Frame Rating	Product Number
All	TDOLB

Racking Tool

The racking tool is a drive wrench with a square 1/2" socket that engages the racking mechanism of the draw-out breaker.

Frame Rating	Product Number
All	TDORT

Mechanical Interlocks

Mechanical interlocks provide the same function as the walking beam accessory for stationary breakers, except they are used with two draw-out breakers: mounted on common compartment centerline, in either the same vertical section or adjacent vertical sections.

Envelope Size	Product Number
800-2000	SPDOWB20
2500-4000	SPDOWB40

Rail Kit

This field installable rail kit may be used to shorten the two standard OEM substructure rails by 3-1/2 inches.

Product Number
SPRAILS

Position Switch

Provides positive indication when the draw-out breaker or switch primary contact fingers have been fully withdrawn from the main bus connections. Switch contacts change state only after the primary fingers are fully disconnected when the breaker is being moved from the CONNECTED position through the TEST position and into the DISCONNECTED position.

May be used as part of a safety interlocking system in addition to the visual indicator on the draw-out substructure. The Position Switch accessory does not indicate either the TEST or CONNECTED position. The switch assembly mounts on the stationary frame and the actuator mounts to the carriage. Switch contacts are rated at 10A at 600 Vac, 0.75A at 125 Vdc, and 0.25A at 250 Vdc.

Number of Switch Elements	Product Number
2 NO/2 NC	SDOPS2L
4 NO/4 NC	SDOPS4L
6 NO/6 NC	SDOPS6L

Reference publications

UL/CSA File Numbers

Power Break™ Breakers	E11592/LR10263
MicroVersaTrip™ Plus and MicroVersaTrip™ PM, EntelliGuard™ TU Trip Unit and Power+ Trip Units	E11592/LR10263
MicroVersaTrip™, EntelliGuard™ TU and Power+ Rating Plugs	E11592/LR10263
Accessories	E57253/LR10263
Molded Case Switches	E57546/LR16271

EntelliGuard™ G

EntelliGuard™ G IOM	DEH-41304
Time Current Curves: EntelliGuard™ TU Trip Unit for EntelliGuard™ G; Long-Time Circuit Breaker Characteristics	DES-090
Time Current Curves: EntelliGuard™ TU Trip Unit for EntelliGuard™ G; Long-Time Fuse-Like Characteristics	DES-091
Time Current Curves: EntelliGuard™ TU Trip Unit for EntelliGuard™ G; Short-Time Pickup and Delay Bands	DES-092
Time Current Curves: EntelliGuard™ TU Trip Unit for EntelliGuard™ G; Ground Fault	DES-093
Time Current Curves: EntelliGuard™ TU Trip Unit for EntelliGuard™ G; Instantaneous, Override (HSIOC), Reduced Energy Let-Through Instantaneous (RELT)	DES-094
UL Component Recognized Series Connected Ratings and CSA Certified Series Rated Combinations	DET-008
Undervoltage Release User Manual	DEH-41361
Time Delay Module User Manual	DEH-41362
Closing Coil User Manual	DEH-41363
Motor Operator User Manual	DEH-41366
Electrical Close Switch	DEH-41374
Spring Charge Contact	DEH-41375
Castell Lock Kit	DEH-41376
Door Interlock User Manual	DEH-41377
Cassette Ronis Lock User Manual	DEH-41380
Contact Wear Indicator User Manual	DEH-41382
Wall Mounting Kit	DEH-41383
IP54 Door	DEH-41384
Escutcheon Kit	DEH-41386
Arcing Contacts Assembly	DEH-41390
Racking Handle	DEH-41392
Cluster Contacts User Manual	DEH-41394
Cluster Pliers Assembly	DEH-41395
Secondary Disconnects - Drawout	DEH-41401
Command Close Coil	DEH-41418
Ready To Close (RTC)	DEH-41419
Coil Signaling Contacts	DEH-41420
	DEH-41430
	DEH-41431
Back Connected Terminations for Cassette	DEH-41433
	DEH-41434
	DEH-41437

EntelliGuard™ G (continued)

	DEH-41439
	DEH-41440
	DEH-41441
Back Connected Terminations for Breaker	DEH-41442
	DEH-41443
	DEH-41444
	DEH-41445
	DEH-41608
Contact Wear Indicator	DEH-41446
	DEH-41447
Cluster pad Assembly	DEH-41448
	DEH-41449
	DEH-41450
Mechanical Interlocks (Fixed)	DEH-41451
Mechanical Interlocks (Drawout)	DEH-41455
Cassette Interlock User Manual	DEH-41459
Clusters	DEH-41460
Network Interlock Device (NI)	DEH-41461
Flat Front Termination ANSI/UL	DEH-41463
Remote Racking Operator	DEH-41467
Key Interlock Casste Mounted	DEH-41500
CVCB Coil Signal Status	DEH-41517
Neutral Sensor Kit – Rogowski	DEH-41387
24 Vdc Power Supply	GEH-6492
Arc Chute Kit	DEH-41389
Earthing Device Kit	DEH-41379
EntelliGuard TU Rating Plugs	DEH-41318
EntelliGuard TU Test Kit	DEH-4568
EntelliGuard TU Trip Unit IOM	DEH-4567

Power Break™ II Time Current Curve-Numbers

	Functions	Curve No.
Enhanced MicroVersaTrip™ Plus and MicroVersaTrip™ PM Trip Units	Long-time Delay with Instantaneous	GES-9890
	Long-time Delay, Short-time Delay with Instantaneous	
	Ground Fault	GES-9889

Continued on page 8-184

Reference publications

Power Break™ II Time Current Curve-Numbers

	Functions	Curve No.
Enhanced MicroVersaTrip™ Plus and MicroVersaTrip™ PM Trip Units	Long-time Delay with Instantaneous or Long-time Delay, Short-time Delay with Instantaneous	GES-9890
	Ground Fault	GES-9889

Power Break™ II Instructions for Breakers and Accessories

Power Break™ II Circuit Breakers– 800-4000 A frames, 240-600 Vac	GEH-6270
Power Break™ II Circuit Breakers– Draw-Out 800-4000 Ampere Frames	GEH-6271
Power Break™ II Circuit Breakers– Draw-Out Substructure	GEH-6272
Power Break™ II Circuit Breakers– Draw-Out Substructure	GEH-6273
Power Break™ II Circuit Breaker Accessories– Auxiliary Switch Module	GEH-6274
Power Break™ II Circuit Breaker Accessories– Bell Alarm-Alarm Only	GEH-6275
Power Break™ II Circuit Breaker Accessories– Door Interlock	GEH-6276
Power Break™ II Circuit Breaker Lug Kits and T Studs	GEH-4546
Power Break™ II Circuit Breaker Accessories– Bell Alarm with Lockout	GEH-6278
Power Break™ II Circuit Breaker Accessories– Key Interlock Provision	GEH-6279
Power Break™ II Circuit Breaker Accessories– Mechanical Counter	GEH-6280
Power Break™ II Circuit Breaker Accessories– Motor Operator Mechanism	GEH-6281
Power Break™ II Circuit Breaker Accessories– Push Button Cover	GEH-6282
Power Break™ II Circuit Breaker Accessories– Remote Close	GEH-6283
Power Break™ II Circuit Breaker Accessories– Shunt Trip	GEH-6284
Power Break™ II Circuit Breaker Accessories– Undervoltage Release	GEH-6285
Power Break™ II Circuit Breaker Accessories– Walking-Beam Interlock	GEH-6286
TVRMS2 Test Kit	GEK-97367
Power Break™ II Circuit Breaker Accessories– Draw-Out Substructure Secondary Disconnect	GEH-6460
Power Break™ II Circuit Breaker Accessories– Draw-Out Substructure Rail Kit	GEH-6440
Walking Beam Interlock 800A, 1600A, 2000A	GEH-6286
Walking Beam Interlock 2500-3000A	DEH-009
Walking Beam Interlock 4000A	DEH-010
Draw Out Mechanical Interlock 800-2000A	DEH-011
Draw Out Mechanical Interlock 2500-4000A	DEH-012
Neutral Kit	DEH-024
Hidden “ON” Button	DEH-025
High Voltage Shunt Trip	GEH-6519
High Voltage Under Voltage Release	GEH-6520
Under Voltage Release Time Delay Relay	GEJ-4699
EntelliGuard™ TU Digital Test Kit	DEH-4568A
EntelliGuard™ TU Conversion/Upgrade Kits	DET-722C
EntelliGuard™ TU Conversion Kits	DEH-3456
EntelliGuard™ TU Conversion Kits	DEH-3456
Drawout Position Switch	DEH-40528
Stop Block Kit	DEH-40466

Power Break™ II Circuit Breakers Trip Units

Power+ Trip Unit	DEH-049
Installation Operation and Maintenance Manual for the UL Version of the EntelliGuard™ TU Trip Unit	DEH-4567

Power Break™ II Circuit Breakers

MicroVersaTrip™ Plus and MicroVersaTrip™ PM Rating Plugs	GEH-5933
EntelliGuard™ TU Rating Plugs	DEH-41318
Enclosures 800-2000A	GEH-6503

Gerapid High Speed DC Circuit Breakers

Gerapid Brochure	DET-379
Gerapid Application Guide	DET-739
Gerapid Users Guide for 2607, 4207, 6007 & 8007	S47183e
Gerapid Users Guide for UL Breakers	S47183De
Gerapid Users Guide for Rectifier Breakers 8007R & 10007	DTR01807

